

Delphi Harsh Environment Series (HES) Connection Systems

The Delphi Harsh Environment Series (HES) Connection Systems include circular connectors, terminals, and a rectangular 50 and 60 way header. The 24 shell size industry standard connector includes six terminal configurations (47, 31, 29, 23, 21, and 19) and is offered with and without backshells. Delphi's circular connection systems are available with straight and right angle conduit wire dress covers on both receptacle and plug assemblies.

The HES Connection Systems provide higher current capability, improved sealing, higher terminal retention and a significant cost advantage compared to standard pin-and-sleeve systems. Delphi HES Connection Systems are also compatible with existing systems in the commercial and agricultural vehicle markets.

► Benefits

- **Terminals**
 - High current performance is realized through the selection of high conductive materials
 - Robust design with a stainless steel sleeve that provides stability and protection to contact interface area
 - Overlapping wing design provides exceptional strain relief and larger outside diameter cable range capability
 - Crimp stability over the terminal life with the use of tin in the crimp area
 - Wide range of cable sizes accommodated with Delphi's crimp design
 - Interchangeability with industry standard terminal products

- **HES Circular Connectors**
 - Sealing performance exceeds expectations with recessed 3-rib design that will maintain sealing properties even if a tight wire dress is applied, providing better sealing capability up to 30% compared to existing designs
 - Superior contact (terminal) retention performance virtually eliminates terminal unseats with a specialized finger design that results in better retention up to 40% when compared to existing designs
 - Interchangeability with industry standard circular products
 - Ergonomic design for ease of assembly and to maintain quality:
 - Arrows help simplify pre-engagement of locking nut for simplified mating
 - Visual lock engagement window
 - Color coded seals to distinguish between various cable diameters as well as terminal gender
 - Low torque engage



HES Connection Systems

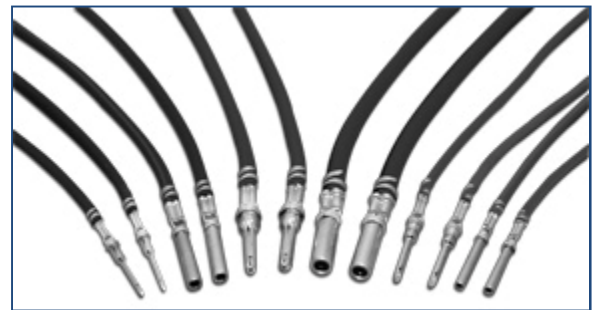

HES Terminals



HES Circular Connectors

- Robust construction through sonic welding the seal retainer construction and using wave spring design that ensures the connection system maintains face seal compression, even when subjected to the high vibration commercial vehicle SAE J-2030 standard



HES Header System

• **Header System**

- Virtually eliminates unseats with Delphi’s two stage terminal retainer design
- High vibration design passes 29 Grms vibration specification
- Chemical resistant header face seals with the use of flourosilicone
- Built-in probing window protect the female terminal during the build process
- Over-torque bolt design protects the header when too much torque is applied
- True pin position is one of the tightest in the industry at 0.225 mm, ensuring easy mounting to a circuit board
- Interchangeability with industry standard products

▶ **Typical Applications**

Delphi Harsh Environment Series products are suited for the following industries:

- Agriculture
- Commercial vehicle
- Construction
- Marine
- Other harsh environment applications

The HES circular design is ideally suited for making connections in a vehicle sheet metal firewall pass-through locations. Because of the rugged connection system design, they are well suited for engine compartments. HES headers are an ideal choice for high density device I/Os that are mounted directly to the engine.

▶ **Specifications for Connectors and Terminals**

Contacts	Size 20 (1.0 mm) Size 16 (1.6 mm) Size 12 (2.4 mm)
Application Tooling	Delphi tooling available for each current configuration
Sealing Plugs	Size 20 and 16 Size 12
Operating Temperature	- 55°C to + 125°C
Durability	No electrical or mechanical defects after 100 cycles of engagement or disengagement (1000 cycles for the diagnostic connector)
Physical Shock	Withstands 50 Gs of mechanical shock in three axes without mechanical failure
Vibration	Sinusoidal vibration of 20 GRMS and random vibration of 12.4 GRMS without physical damage or loss of continuity
Sealing Capability	IP67 rating Withstands high pressure spray of 375 cycles of 1020 psi @ 150 gal/hr. Withstands water submersion of 3 feet without water intrusion

Cable Range for Optimal Sealing	Contact size:	Blue Seal:	Orange Seal:
	Size 20 (1.0)	1.10 - 2.40 mm ²	1.80 - 3.05 mm ²
	Size 15 (1.6)	1.30 - 2.85 mm ²	2.25 - 3.70 mm ²
	Size 12 (2.4)	2.45 - 3.60 mm ²	2.90 - 4.30 mm ²
Corrosion Resistance	No corrosion after exposure to 100 hrs of salt fog		
Electrical			
Contact Current Rating	Contact Size:	Max. Current (Amps):	
	Size 20	18	
	Size 16	28	
	Size 12	40	
Contact Resistance	10 mΩ for cable ≤ 18 Ga. 6.7 mΩ for cable > 16 Ga.		
Dielectric Withstanding Voltage	1000 V AC		
Insulation Resistance	Greater than 20 MΩ		
Mechanical			
Contact Retention to Housing	Contact Size:	Retention Force:	
	Size 20	160 N	
	Size 16	270 N	
	Size 12	365 N	
Mating Torque	Less than 4 Nm		
Un-mating Torque	Less than 4 Nm		
Physical			
Housing	Glass filled nylon		
Seals	Silicone		
Contact	Copper alloy		
Female Terminal Hood	Stainless steel		
Plating	Nickel and gold with tin in crimp area		

▶ **HES 24 Shell Terminal Patterns**

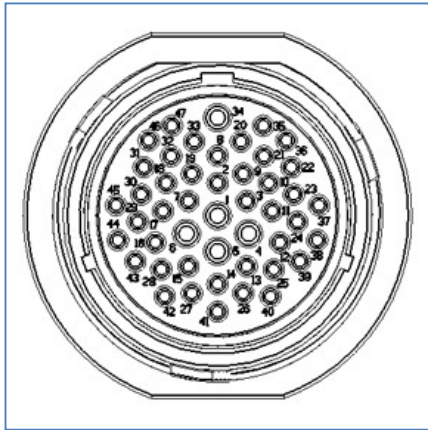

47 Way
42 size 20
5 size 16
Thin wall (blue seal)

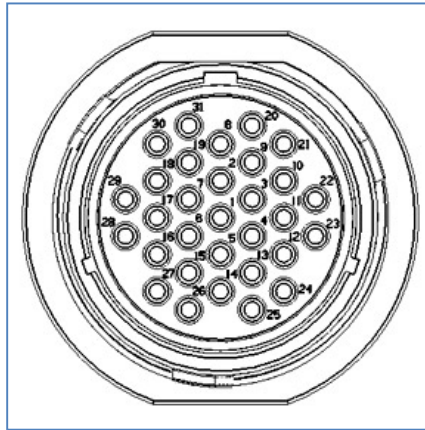

31 Way
31 size 16
Thin wall (blue seal)
Regular/heavy wall (orange seal)

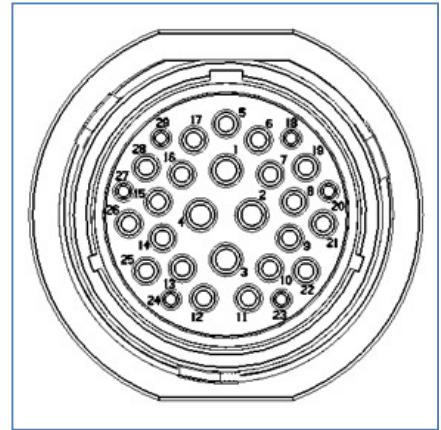

29 Way
6 size 20
19 size 16
4 size 12
Thin wall (blue seal)
Regular/heavy wall (orange seal)

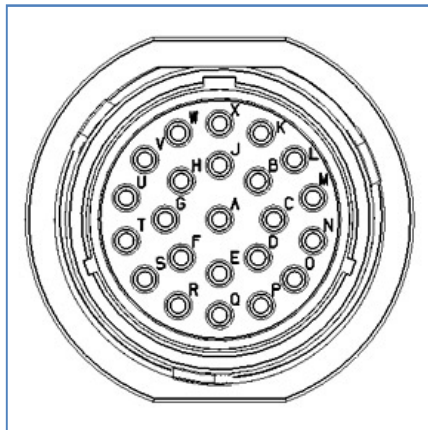

23 Way
23 size 16
Thin wall (blue seal)
Regular/heavy wall (orange seal)

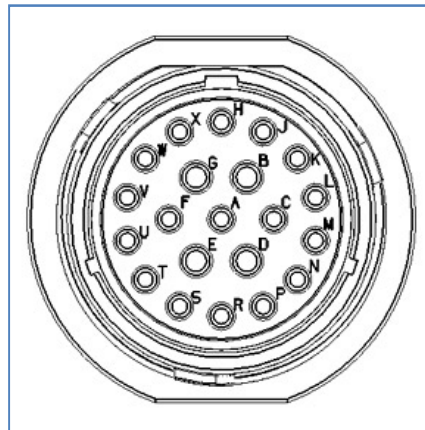

21 Way
17 size 16
4 size 12
Thin wall (blue seal)

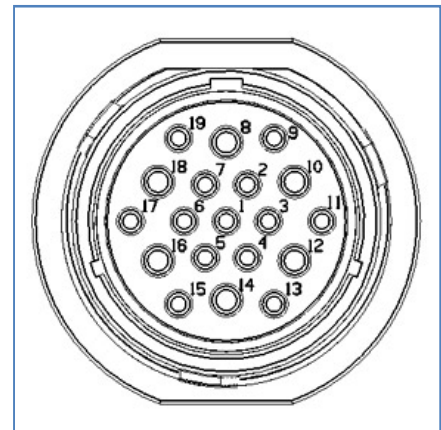

19 Way
13 size 16
6 size 12
Thin wall (blue seal)

▶ **HES Circular Connector Assemblies — Standard Configuration**

Number of Cavities	Cable Type- Seal Color *	Part Number (Receptacle Plastic Male Terminals)	Part Number (Plug Plastic Female Terminals)
47	TXL - blue	13719103	13719104
31	TXL - blue	13719105	13719106
	G/SXL - orange	13719107	13719108
23	TXL - blue	13719113	13719114
	G/SXL - orange	13719115	13719116
29	TXL - blue	13719109	13719110
	G/SXL - orange	13719111	13719112
21	TXL - blue	13719117	13719118
	G/SXL - orange	13719119	13719121
19	TXL - blue	13719123	13719124
	G/SXL - orange	13719125	13719126

▶ **HES Circular Connector Assemblies — Reverse Configuration**

Number of Cavities	Cable Type- Seal Color *	Part Number (Receptacle Plastic Female Terminals)	Part Number (Plug Plastic Male Terminals)
31	TXL - blue	13765456	13765454
	G/SXL - orange	13765457	13765455
19	TXL - blue	13765460	13765458
	G/SXL - orange	13765461	13765459

*Light seal color represents female/sleeve terminal
 Dark seal color represents male/pin terminal

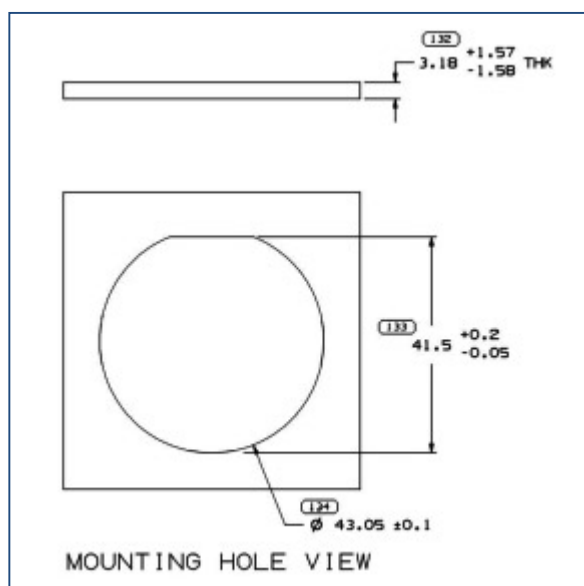

Mounting specification for the HES size 24 receptacle

▶ **Conduit Backshell Wire Dress**

Part Number	Conduit Size	Configuration
13767802	19	Wire dress straight
13767803	22	
13667839	25	
13767805	19	Wire dress right angle
13767806	22	
13667840	25	

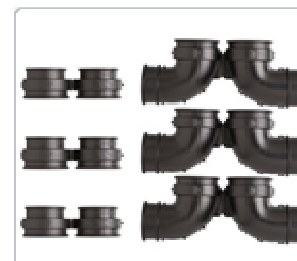

HES non-threaded backshell conduit adaptors

▶ **Cavity Seal Plugs**

Part Number	Terminal Cavity
13756464	Size 20 and 16
13756465	Size 12

▶ **Miscellaneous Accessories**

Part Number	Description
13780240	Gasket
13813956	Gasket with adhesive
13752446	Shipping cover (reverse pin cover)
13668988	Shipping cover (standard pin cover)
15417623	Nut
13840220	Lock washer





HES plugs



▶ **Specifications for the 50/60 Way Header Connections**

Contacts	Size 20 (1.0 mm)
Sealing Plugs	Size 20 (Note: Different part number than HES circulars)
Operating Temperature	- 55°C to + 125°C
Physical Shock	Withstands 50 Gs of mechanical shock in three axes without mechanical failure
Vibration	29.4 Grms
Sealing Capability	IPX7
Corrosion Resistance	No corrosion after exposure to 100 hours of salt fog Chemical resistant flourosilicon face seal on the header
Electrical	
Contact Current Rating	Size 20: 18 amps maximum current
Contact Plating	Selective gold with tin in crimp area on the female contact Gold flash palladium on the header pins
Mechanical	
Contact Retention to Housing	Contact size: Retention force: Size 20 90 N
Physical	
Housing	High temperature, glass filled nylon
Seals	Flourosilicone face seals Silicone cable seals
Contact	Copper alloy
Plating	Female: Gold with tin in crimp area Male: Gold flash palladium

▶ **HES 50-way Header System**

Top Mount Header Part Number	Female Plug Connector Part Number	Index
		
13836626	13837191	1
13836627	13837192	2
13836628	13837193	3
13836629	13837194	4
13836630	13837195	5
13936631	13837196	6
13636632	13837197	7
13636633	13837198	8
13836634	13837199	9
13836635	13837200	10

▶ **Miscellaneous HES 50/60-Way Header System**

Bottom Flange Mount Header Part Number	Top Mount Header Part Number	Female Plug Connector Part Number	Index
			
Not available	13836616	13837180	1
Not available	13836617	13837181	2
Not available	13836618	13837182	3
Not available	13836619	13837183	4
1380606	13836620	13837184	5
13806064	13836621	13837185	6
13806065	13836622	13837186	7
Not available	13836623	13837187	8
Not available	13836624	13837188	9
Not available	13836625	13837189	10

▶ **Miscellaneous HES 50/60 Way Header Accessories**

Part Number	Description
15475969	Backshell 60-way
15475968	Backshell 50-way
12129557	Cavity plug



HES Header Accessory

▶ **The Delphi Advantage**

Delphi is one of the world's leading automotive suppliers of advanced terminals, connectors, sealing, wiring and cable products. Delphi's deep understanding of various connection system technologies and the company's vast research and development capabilities have enabled continuing innovation.

Delphi is a source for high value solutions and our expertise is built into every product. Delphi has a thorough understanding of markets around the world and a global network of resources. Delphi relies on its global capabilities, consistent processes, and extensive testing to develop and manufacture a comprehensive offering of terminals, connectors, sealing, wiring and cable products. The result is that Delphi provides customers with robust, reliable products and world-class quality.