

Glencair®

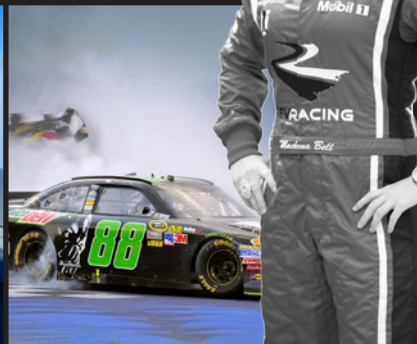

Out of This World  
**INTERCONNECT  
SOLUTIONS**





Out of This World

# INTERCONNECT SOLUTIONS



## SELECTION GUIDE

- Contacts, Wires and Cables**
- SAE-AS39029 Crimp Contacts
  - High Performance Shielded Contacts
  - Special Purpose Contacts
  - El Ochito® : The Ultimate Ethernet Contact
  - Bulk Interconnect Cable
  - Data Transmission Wire and Cable

A

- Ultraminiature Circular Connectors and Cable Assemblies**
- Series 80 Mighty Mouse Connectors
  - Series 824 Mighty Mouse Locking Push-Pull Connectors
  - Low-Profile Mighty Mouse Cobra Connectors
  - Series 80 High-Speed Mighty Mouse Connectors
  - Series 811 High-Density (HD) Mighty Mouse Connectors
  - USB SuperSeal™ Ethernet Connectors
  - Series 88 SuperFly® Ultraminiature Cordsets
  - HiPer 55116 Audio Frequency Connectors
  - Series 151 MIL-DTL-55116 Type Audio Connectors
  - Series 15 "CB" Pogo Pin Audio Connectors

B

- Mil-Aero Circular Connectors and Cable Assemblies**
- SuperNine® MIL-DTL-38999 Series III Type Connectors
  - Mil-Aero Cylindrical Connector Specials
  - Glass-Sealed Hermetic Connectors
  - EMI/EMP Filter Connectors
  - SuperSeal™ RJ45 / USB Field Connectors
  - MIL-DTL-38999 Series IV Type Breech-Lock Connectors
  - Sav-Con® Connector Savers
  - MIL-DTL-28840 Connectors

C

- Industrial-Strength Power and Signal Connectors and Cable Assemblies**
- Series ITS Industrial Power and Signal Connectors
  - High-Current/High-Voltage Power Connectors
  - PowerTrip™ Extreme Environment Power Connectors
  - RJ45 and USB SuperSeal™ for Industrial/Rail Applications
  - Octobyte™ High-Speed Ethernet Connector
  - GeoMarine® and Seacrow Harsh-Environment Connectors

D

- Rectangular Connectors and Cable Assemblies**
- AlphaLink® Board-Level Connectors and Flex Jumpers
  - Series 89 MIL-DTL-32139 Nanominiature Connectors
  - MIL-DTL-83513 Micro-D Connectors
  - SpaceWire Flight and Lab Grade Cable Assemblies
  - MasterLatch® Quick-Disconnect Micro-D
  - Well-Master™ 260° High-Temperature Micro-D
  - Series 79 Micro-Crimp Connectors
  - Super-Twin™ Lightweight Composite Modular Connectors
  - Series 28 HiPer-D 24308 Compatible Connectors
  - ARINC 600 Filter Connectors

E

- Fiber Optic and Opto-Electronic Interconnect Systems**
- MIL-DTL-38999 Fiber Optic Connection System
  - GHD High Density Fiber Optic Connection System
  - Series 80 Mighty Mouse Fiber Optic Connection System
  - MIL-PRF-28876 Fiber Optic Connection System
  - GFOCA M83526 Compliant Fiber Optic Connection System
  - Eye-Beam™ and Hi-Beam™ Expanded Beam Fiber Optics
  - Size 8 Cavity Opto-Electronic Contacts
  - PCB-Mount Opto-Electronic Transceivers
  - Harsh-Environment Opto-Electronic Connectors
  - Copper-to-Fiber Media Converters
  - Signal Aggregation Media Converters
  - Ethernet Switches

F

- Shrink Boots, Jackets and Shields**
- Series 77 Full Nelson Environmental Shrink Boots
  - TACOM and VG Approved Boots and Adhesives
  - Piggyback Boot Backshell Adapters
  - Heat Shrink Termination (HST) Sleeves
  - Duralectric™, Viton® and other Cable and Conduit Jacketing
  - AmberStrand® Lightweight Composite EMI/RFI Shielding
  - ArmorLite™ Lightweight Stainless Steel EMI/RFI Shielding
  - Metal Braided Shielding and Fabric Braided Sleeving
  - MIL-DTL-24749 Type IV Qualified Ground Straps
  - Lightweight ArmorLite™ Microfilament Ground Straps

G

- Metal and Polymer Core Conduit Systems**
- Series 72 Annular Polymer Core Conduit Systems
  - Series 74 Helical Polymer Core Conduit Systems
  - Series 75 Metal-Core Conduit Systems
  - MIL-PRF-24758/Special-Purpose Conduit Systems

H

- Backshells and Other Connector Accessories**
- Circular Connector Backshells and Accessories
  - Rectangular Connector Backshells and Accessories
  - Composite Backshells and Accessories
  - EMI/RFI CostSaver Composite Junction Boxes

J

- Interconnect Assembly Tools**
- BandMaster™ ATS EMI/RFI Shield Termination System
  - Backshell to Connector Assembly Tools

K

- High Reliability Cable Assemblies and Integrated Systems**
- Overmolded and ASAP Cable Assemblies
  - Wired Conduit Assemblies
  - Flex Circuit Assemblies
  - Pure Air/Nitrogen Tubing Systems
  - Hold-Down Release Mechanisms
  - Integrated Systems

L



# High Performance Connector Contacts, Wire and Cable



Glenair brings a new perspective to the supply of high-performance Mil-Spec and commercial contacts, wire and cable: High Availability! Whether you need a standard duty socket contact for a MIL-DTL-28840 connector or an extended duty pin for MIL-DTL-38999 Series III, we have you covered with products that are always in stock—with no dollar or quantity minimums. In addition to the broadest selection and availability, Glenair also delivers outstanding interconnection compatibility. Glenair QPL SAE-AS39029 as well as our proprietary contact series are guaranteed to mate properly and perform at the upper limits of application requirements.

We Never Lose Contact! A Sampling of Glenair Contact Families

Standard and High-Density Signal Contacts	TwistPin Contacts	El Ochito®	
Coaxial Contacts	Pneumatic Contacts	Wire Adapters	Thermocouple
Differential Twinax	100 Ohm Quadrax	Shielded	Power
Concentric Twinax	Printed Circuit Board	Opto-Electronic	Fiber Optic Termini
Bulk Interconnect Cable • Data Transmission Wire and Cable • Flex Circuit Design and Manufacturing			

For more information contact Glenair at 818-247-6000 or visit our website at [www.glenair.com](http://www.glenair.com) U.S. CAGE code 06324





A

Military Part Number	Glenair Part Number	Contact Size	Wire Accommodation	Pin / Socket	BIN Color Striping		
M39029/56-348	850-001-22-348	22	22-28 AWG	Socket	Orange	Yellow	Grey
M39029/56-351	850-001-20-351	20	20-24 AWG	Socket	Orange	Green	Brown
M39029/56-352	850-001-16-352	16	16-20 AWG	Socket	Orange	Green	Red
M39029/56-353	850-001-12-353	12	12-14 AWG	Socket	Orange	Green	Orange
M39029/56-527	850-001-10-527	10	10 AWG	Socket	Green	Red	Violet
M39029/57-354	850-003-22-354	22	22-28 AWG	Socket	Orange	Green	Yellow
M39029/57-357	850-003-20-357	20	20-24 AWG	Socket	Orange	Green	Violet
M39029/57-358	850-003-16-358	16	16-20 AWG	Socket	Orange	Green	Grey
M39029/57-359	850-003-12-359	12	12-14 AWG	Socket	Orange	Green	White
M39029/58-360	850-002-22-360	22	22-28 AWG	Pin	Orange	Blue	Black
M39029/58-363	850-002-20-363	20	20-24 AWG	Pin	Orange	Blue	Orange
M39029/58-364	850-002-16-364	16	16-20 AWG	Pin	Orange	Blue	Yellow
M39029/58-365	850-002-12-365	12	12-14 AWG	Pin	Orange	Blue	Green
M39029/58-528	850-002-10-528	10	10 AWG	Pin	Green	Red	Grey
M39029/63-368	850-021-20-368	20	20-24 AWG	Socket	Orange	Blue	Grey
M39029/64-369	850-022-20-369	20	20-24 AWG	Pin	Orange	Blue	White

BIN Color Coding									
0 BLACK	1 BROWN	2 RED	3 ORANGE	4 YELLOW	5 GREEN	6 BLUE	7 VIOLET	8 GREY	9 WHITE

A

Military Part Number	Glenair Part Number	Contact Size	Wire Accommodation	Pin / Socket	BIN Color Striping		
M39029/83-450	850-004-20-450	20	22-26 AWG	Pin	Yellow	Green	Black
M39029/83-451	850-004-20-451	20	28-32 AWG	Pin	Yellow	Green	Brown
M39029/83-508	850-004-20-508	20	20-24 AWG	Pin	Green	Black	Grey
M39029/84-452	850-005-20-452	20	22-26 AWG	Socket	Yellow	Green	Red
M39029/84-453	850-005-20-453	20	28-32 AWG	Socket	Yellow	Green	Orange
M39029/84-509	850-005-20-509	20	20-24 AWG	Socket	Green	Black	White
M39029/106-614	850-006-22-614	22	22-28 AWG	Socket	Blue	Brown	Yellow
M39029/106-615	850-006-20-615	20	20-24 AWG	Socket	Blue	Brown	Green
M39029/106-616	850-006-16-616	16	16-20 AWG	Socket	Blue	Brown	Blue
M39029/106-617	850-006-12-617	12	12-14 AWG	Socket	Blue	Brown	Violet
M39029/106-618	850-006-10-618	10	10 AWG	Socket	Blue	Brown	Grey
M39029/107-620	850-007-22-620	22	22-28 AWG	Pin	Blue	Red	Black
M39029/107-621	850-007-20-621	20	20-24 AWG	Pin	Blue	Black	Brown
M39029/107-622	850-007-16-622	16	16-20 AWG	Pin	Blue	Red	Red
M39029/107-623	850-007-12-623	12	12-14 AWG	Pin	Blue	Red	Orange
M39029/107-624	850-007-10-624	10	10 AWG	Pin	Blue	Red	Yellow

BIN Color Coding									
0 BLACK	1 BROWN	2 RED	3 ORANGE	4 YELLOW	5 GREEN	6 BLUE	7 VIOLET	8 GREY	9 WHITE



# High-Performance Shielded Contacts

## Selection guide



# High-Performance Shielded Contacts

## Selection guide



**A**

Military Part Number	Glenair Part Number	Contact Size	Pin / Socket	Type	BIN Color Striping		
M39029/27-210	852-001-12-210	12	Socket	Coaxial	Red	Brown	Black
M39029/27-402	852-001-12-402	12	Socket	Coaxial	Yellow	Black	Red
M39029/27-403	852-001-12-403	12	Socket	Coaxial	Yellow	Black	Orange
M39029/27-404	852-001-12-404	12	Socket	Coaxial	Yellow	Black	Yellow
M39029/27-405	852-001-12-405	12	Socket	Coaxial	Yellow	Black	Green
M39029/27-406	852-001-12-406	12	Socket	Coaxial	Yellow	Black	Blue
M39029/27-407	852-001-12-407	12	Socket	Coaxial	Yellow	Black	Violet
M39029/27-408	852-001-12-408	12	Socket	Coaxial	Yellow	Black	Gray
M39029/28-211	852-002-12-211	12	Pin	Coaxial	Red	Brown	Brown
M39029/28-409	852-002-12-409	12	Pin	Coaxial	Yellow	Black	White
M39029/28-410	852-002-12-410	12	Pin	Coaxial	Yellow	Brown	Black
M39029/28-411	852-002-12-411	12	Pin	Coaxial	Yellow	Brown	Brown
M39029/28-412	852-002-12-412	12	Pin	Coaxial	Yellow	Brown	Red
M39029/28-413	852-002-12-413	12	Pin	Coaxial	Yellow	Brown	Orange
M39029/28-414	852-002-12-414	12	Pin	Coaxial	Yellow	Brown	Yellow
M39029/28-415	852-002-12-415	12	Pin	Coaxial	Yellow	Brown	Green
M39029/59-366	852-006-08-366	08	Socket	Coaxial	Orange	Blue	Blue
M39029/60-367	852-007-08-367	08	Pin	Coaxial	Orange	Blue	Violet
M39029/75-416	852-003-12-416	12	Socket	Coaxial	Yellow	Brown	Blue
M39029/75-417	852-003-12-417	12	Socket	Coaxial	Yellow	Brown	Violet
M39029/75-418	852-003-12-418	12	Socket	Coaxial	Yellow	Brown	Gray
M39029/75-419	852-003-12-419	12	Socket	Coaxial	Yellow	Brown	White
M39029/75-420	852-003-12-420	12	Socket	Coaxial	Yellow	Red	Black
M39029/75-421	852-003-12-421	12	Socket	Coaxial	Yellow	Red	Brown
M39029/75-422	852-003-12-422	12	Socket	Coaxial	Yellow	Red	Red
M39029/75-423	852-003-12-423	12	Socket	Coaxial	Yellow	Red	Orange
M39029/76-424	852-008-16-424	16	Pin	Coaxial	Yellow	Red	Yellow
M39029/76-425	852-008-16-425	16	Pin	Coaxial	Yellow	Red	Green

BIN Color Coding									
0 BLACK	1 BROWN	2 RED	3 ORANGE	4 YELLOW	5 GREEN	6 BLUE	7 VIOLET	8 GREY	9 WHITE

**A**

Military Part Number	Glenair Part Number	Contact Size	Pin / Socket	Type	BIN Color Striping		
M39029/76-426	852-008-16-426	16	Pin	Coaxial	Yellow	Red	Blue
M39029/76-427	852-008-16-427	16	Pin	Coaxial	Yellow	Red	Violet
M39029/77-428	852-009-16-428	16	Socket	Coaxial	Yellow	Red	Gray
M39029/77-429	852-009-16-429	16	Socket	Coaxial	Yellow	Red	White
M39029/77-430	852-009-16-430	16	Socket	Coaxial	Yellow	Orange	Black
M39029/77-431	852-009-16-431	16	Socket	Coaxial	Yellow	Orange	Brown
M39029/78-432	852-010-16-432	16	Socket	Coaxial	Yellow	Orange	Red
M39029/78-433	852-010-16-433	16	Socket	Coaxial	Yellow	Orange	Orange
M39029/78-434	852-010-16-434	16	Socket	Coaxial	Yellow	Orange	Yellow
M39029/78-435	852-010-16-435	16	Socket	Coaxial	Yellow	Orange	Green
M39029/90-529	853-001-08-529	8	Pin	Concentric Twinax	Green	Red	White
M39029/91-530	853-002-08-530	8	Socket	Concentric Twinax	Green	Orange	Black
M39029/102-558	852-004-12-558	12	Pin	Coaxial	Green	Green	Gray
M39029/103-559	852-005-12-559	12	Socket	Coaxial	Green	Green	White
M39029/113-625	853-003-08-625	8	Pin	Concentric Twinax	Blue	Red	Green
M39029/113-626	853-003-08-626	8	Pin	Concentric Twinax	Blue	Red	Blue
M39029/114-628	853-004-08-628	8	Socket	Concentric Twinax	Blue	Red	Gray
M39029/114-629	853-004-08-629	8	Socket	Concentric Twinax	Blue	Red	White
N/A	854-001-01	8	Pin	Quadrap	N/A		
N/A	854-001-02	8	Pin	Quadrap	N/A		
N/A	854-001-03	8	Pin	Quadrap	N/A		
N/A	854-001-04	8	Pin	Quadrap	N/A		
N/A	854-001-05	8	Pin	Quadrap	N/A		
N/A	854-002-01	8	Socket	Quadrap	N/A		
N/A	854-002-02	8	Socket	Quadrap	N/A		
N/A	854-002-03	8	Socket	Quadrap	N/A		
N/A	854-002-04	8	Socket	Quadrap	N/A		
N/A	854-002-05	8	Socket	Quadrap	N/A		

BIN Color Coding									
0 BLACK	1 BROWN	2 RED	3 ORANGE	4 YELLOW	5 GREEN	6 BLUE	7 VIOLET	8 GREY	9 WHITE





## Special Purpose Contacts Selected Examples

### Size #12 Differential Twinax Contacts for Multi-Gigabit Data Rate Applications

Glenair Part No.	Cable	Impedence	Frequency Range	VSWR	Insertion Loss
Socket = 853-015-01 Pin = 853-016-01	859-041 963-001	100-Ohms Nominal	DC to 10 GHz	1.1 + (.03 * F GHz)	1.3 *F GHz



### 050-301 Size #8 Contact Cavity Optoelectronic Insert Transmitter and Receiver

- ARINC 664, 801, 803, 804, and 818 standard compliant
- Data rates from 125Mbps to 3.8 Gbps for transmitter, 125Mbps to 4.25Gbps for receiver
- Supports fast and Gigabit Ethernet, AFDX, 1x/2x Fibre Channel, DVI, HDMI, SFPDP, Serial Rapid I/O (sRIO).
- ARINC 801 1.25mm/2.5mm ceramic fiber ferrule, or expanded beam



### Thermocouple Contacts to Fit D38999 Series I, II, III and IV Connectors

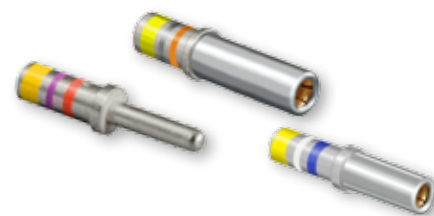

Glenair Part No.	Military Part No.	AWG Wire Size
Pin = 850-023	Pin = AS39029/87	16-28
Series I, III, IV Socket = 850-024	Series I, III, IV Socket = AS39029/88	
Series II Socket = 850-025	Series II Socket = AS39029/89	
Custom PCB and crimp termination thermocouples available in type K, E, J, N and more.		

### Wire-to-Contact Expansion and Reducer Adapters

Glenair Part No.	Finish	Wire Accommodation	Contact Wire Barrel Size
687-348	Z2 - Gold Plate Z3 - Silver Plate	6, 8, 10, 12, 14, 16, 18, 20, 22, 24, 0-4	4, 8, 12, 16, 20, 22
859-015	Z4 - Tin Plate	10, 12, 14, 16, 18, 20, 22, 24, 26, 28	10, 12, 16, 20, 22

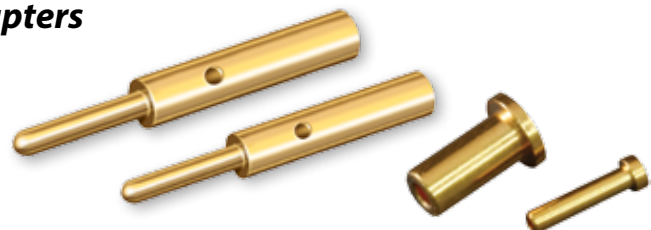

### PCB Contacts to Fit MIL-DTL-38999/20 and /24 Rear-Release Connectors

Mating End Size	Glenair Part Number
22	850-010-22
20	850-010-20
16	850-010-16
12	850-010-12

Mating End Size	Glenair Part Number
22	850-011-22
20	850-011-20
16	850-011-16
12	850-011-12



## Special Purpose Contacts Selected Examples

### High-Power and LouverBand Contacts



High-Power Contacts		
Contact Cavity Size	Wire Accommodation	Glenair Part Number
8	8 AWG	850-013 (Socket) 850-014 (Pin)



High ampacity LouverBand contacts for use in Glenair Series 970 PowerTrip™  
850-026 (pin) 850-027 (skt)

### High-Pressure Assemblies for Pure Gas Pneumatic/Hydraulic Applications



831-001 #12 Gas Tube Assembly for MIL-DTL-38999 Series I, III, and IV



D38999 Ser. I, III, IV

### Size #12 Pneumatic Contacts



Contact Type	For Use In	Part Number
Socket	D38999 Type Series I, III, IV	830-005
Socket	D38999 Series II, Series 79 and Series 80	830-004 <sup>1</sup>



Contact Type	For Use In	Part Number
Pin	D38999 Type, All Series, Series 80 and Series 79	830-003 <sup>2</sup>

1. 830-004 supersedes 857-010
2. 830-003 supersedes 857-011

### Grommet Sealing Plugs

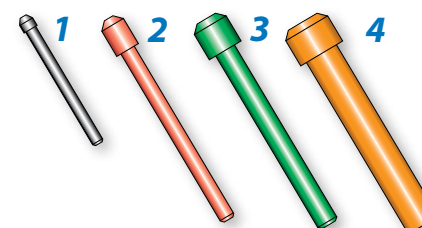
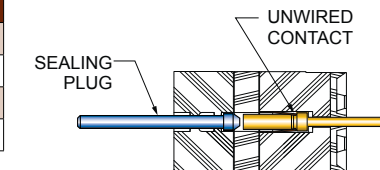

Fig.	Size	Color	Part Number	Military Part Number
1	#23	Black	809-155	(None)
2	#20	Red	859-012	MS27488-20-2
3	#16	Green	859-013	MS27488-16-2
4	#12	Orange	859-014	MS27488-12-2

All sizes available and in Same-Day stock. Consult factory for more information.



### Crimp Tool And Positioner For #12, #16 and #20 Power Contacts, Crimp Adapters



**1** Crimp tool for use with size #20, #16 and #12 power pins. 9.75 inches OAL, 1.25 pounds. Use with M39029/57 and /58 contacts and 809-093 adapters.

**2** Positioner for use with 809-093 adapters.

**3** Positioner for use with size #20, #12 and #16 Power contacts.

Glenair offers a complete line of crimp tools in Same-Day stock.

Figure	Part Number	Military Part Number	Daniels Part Number
1	809-136	M22520/1-01	AF8
2	809-137	M22520/1-04	TH163
3	809-138	(none)	TH653





# El Ochito™: The Ultimate Ethernet Contact

“The Little Eight”: Eight miniaturized contacts in a standard size #8 shielded module—10G Ethernet ready, with dramatic size and weight reduction compared to all other available solutions

- One full Ethernet channel per standard size #8 cavity
- Fast and easy crimp termination of wires to contacts—PC Tails available
- 100% drop-in solution to installed connectors—no redesign or reinstallation of interfaces
- Supplied as crimp contacts, wire pigtails, or in PC tail configurations in the connector of your choice—up to 8 Ochito modules in a size 25 D38999
- Integral spline and short termination maximizes interconnect/cable performance and minimizes crosstalk
- El Ochito™ delivers the highest density contact system available—twice the density of Quadrax, split Quadrax, or other shielded contact solutions
- Tested, qualified, and in-stock for immediate shipment

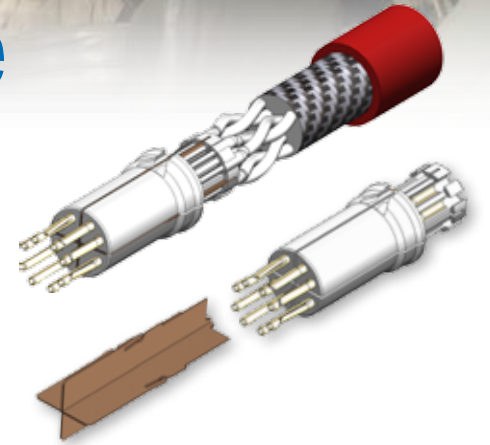

El Ochito™ exploded view: High mating durability, lightweight contact system with 100 Ohm shielded performance. Note wire twist maintained to contact pair to minimize characteristic impedance mismatch. Also, Conductive isolation shield dramatically reduces crosstalk

El Ochito™ is a drop-in solution for Series 80 Mighty Mouse, as well as D38999 Series III, EN4165, EN3645, and other ARINC standards and is ideally suited for Ethernet, high-definition video, high-speed data loading, and other 1Gb/sec and 10Gb/sec applications.

## El Ochito™: The Ultimate Ethernet Contact



How-To-Order El Ochito™ Contacts	
	
<b>858-003</b> Size 8 Ochito 26-AWG crimp Pin	<b>858-004</b> Size 8 Ochito 26-AWG crimp Socket



El Ochito™ utilizes Stinger™ contact technology. These small, durable, low mating force contacts provide El Ochito™ with optimized performance.

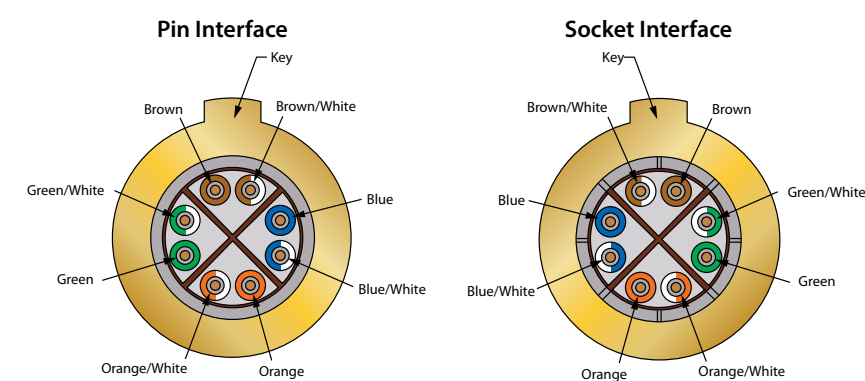

Recommended wire-to-contact assignments

Contact Performance Specifications	
Temperature Range	-55°C to +175°C
Environmental Sealing	IAW connector specification
Corrosion Resistance	48 hours salt spray
Fire, Smoke and Toxicity	IAW FAR 25
EMI Shielding	360° shielding for each pair
Nominal Current	1 Amp
Contact Resistance	Max 60 milliohms
Wire	IAW TIA/EIA Cat 6A and ISO E <sub>A</sub>
Mating Cycles	> 500
DWV	500 VAC RMS sea level

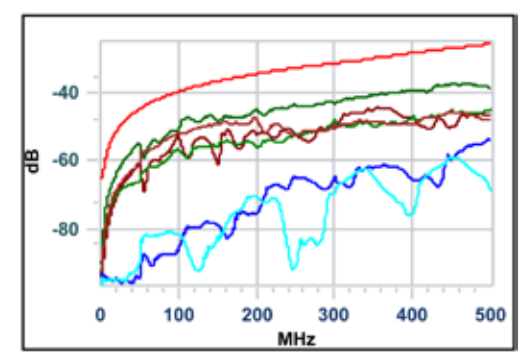

Near End Crosstalk · Cat 6a · 500 MHz

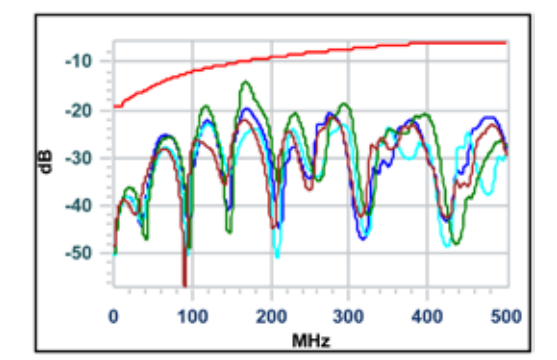

Return Loss · Cat 6a · 500 MHz

### AEROSPACE-GRADE CAT 6a CABLE FOR OCHITO CONTACTS 963-003-26

#### CABLE PHYSICAL DATA

- Conductors: 26AWG stranded SPC
- Shield coverage: 80% (braid)
- Temperature: -55°C to +200°C
- Outer diameter: 0.220" (5.6mm)
- Minimum bend radius: 1.13" (28.7mm)
- Weight (lbs/100 ft): 3.05 (4.54 kg/100m)

#### CABLE CONSTRUCTION

1. White PTFE laser-printable jacket
2. Silver-plated copper shield
3. Fluoropolymer tape
4. PFA insulation
5. Fluoropolymer spline
6. Silver-plated copper conductors

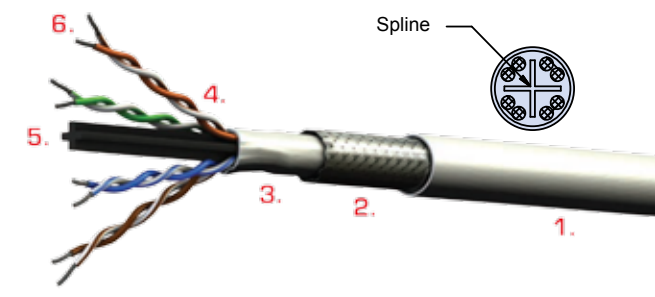



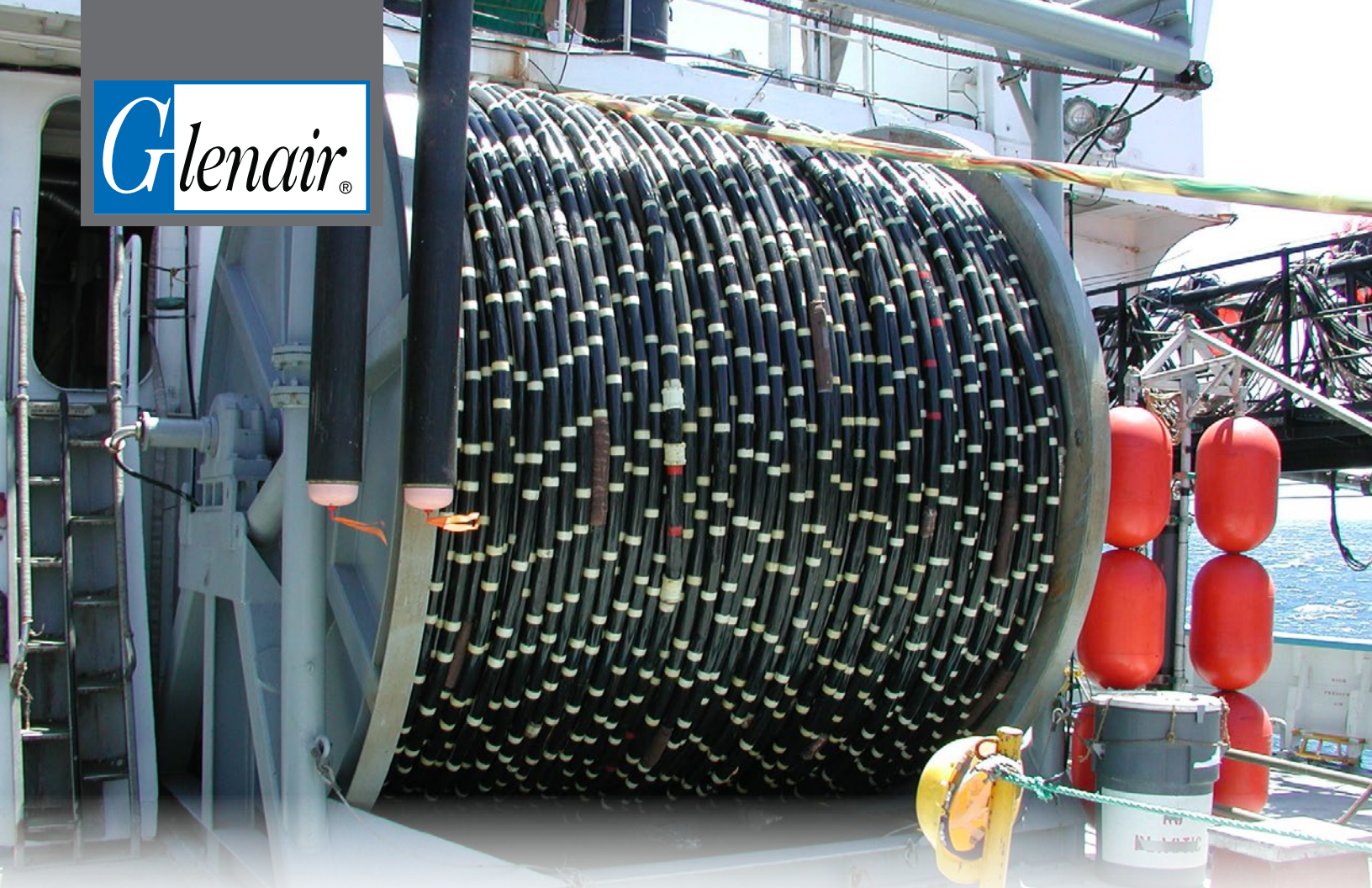

SERIES 96  
High-Performance Custom Bulk Cable  
for Interconnect Applications



A

SERIES 96

# High-Performance Bulk Cable for Interconnect Applications

Rugged high-performance environmental and EMC interconnect cable designs—from chemically-resistant jacketed solutions to high-flexibility power transmission cable

**NO MIN.**  
No Dollar or Quantity Minimum Orders

Glenair is pleased to offer our customers custom bulk cable for on-site termination. Glenair cables are designed and manufactured for optimal performance in mission-critical applications such as soldier systems, medical equipment, aerospace, geophysical and other military and commercial environments that rely on guaranteed signal integrity and cable durability. Cable jacketing, braiding and shielding technologies are specified according to application type, and the unique requirements of inner conductors including non-impedance-controlled signal wire, shielded multi-conductor cables, Coaxial, QuadraX, flexible power, fiber optic, and so on. Glenair cables are designed to optimize flexibility, weight reduction, ruggedness, and insulator quality. Our protocol-specific cables are offered with guidance as to shielding properties, impedance performance, attenuation, temperature rating, bend radius, weight, and maximum practical distance.



Coiled cable configurations for radio and comms applications are a Glenair specialty



Rugged environmental jacketing in a broad range of material types and colors

- Extruded, blown-on and heat shrink jacketing for harsh application environments
- General purpose polyurethane
- Low-smoke, zero halogen Duraelectric™
- Chemically-resistant Viton®
- Industry standard neoprene
- Selected materials CBRN tested

High-performance cable and jacketing materials for every application requirement: Immersion, chemical or caustic fluid exposure, temperature extremes, and UV radiation.



Custom Capabilities	
<b>TurboFlex</b>	Highly flexible interconnect conductors and cables for power distribution applications
<b>Duraelectric</b>	High-performance, flexible jacket material with outstanding resistance to environmental stress factors including heat, UV radiation and caustic chemicals
<b>Multiconductor cables</b>	Custom cables for unique applications such as robotics, defense electronics, and soldier systems
<b>Overbraiding</b>	Extensive range of conductive and non-conductive wire and fabric braid materials, including ultra-lightweight composites and micro-filaments

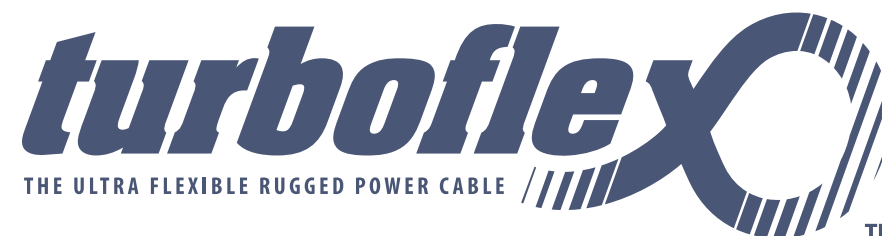

TurboFlex™ power distribution cables are constructed from highly flexible conductors and high-performance insulation to produce cables ideally suited for applications where flexibility, durability, and weight reduction are required. Amazingly durable and flexible—especially in cold weather—the 16 AWG to 450 MCM TurboFlex cable features high strand count rope lay inner conductors made with copper-, tin-, nickel- and silver-plated copper. TurboFlex is jacketed with Glenair's unique Duraelectric™



Available in a broad range of gages, 16 AWG to 450 MCM



Glenair's vertically integrated connector, hardware and cable facilities are perfectly positioned to supply catalog and custom short cable runs for the broad range of interconnect applications.



In-stock and available for immediate, same-day shipment. No minimums!



A

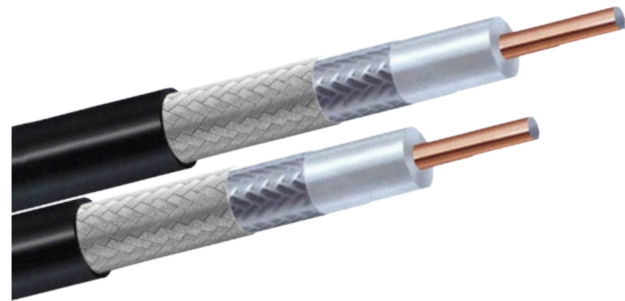

High-Speed Coaxial Cable

- One-stop shopping for general-purpose, high-speed, and protocol-specific/ specialty wire and cable
- No minimum orders. Glenair wire and cable part numbers are in stock and ready for immediate, same-day shipment
- M22759 single-ended data transmission wire, high-speed Quadrax cable, 50 and 75 Ohm Coaxial cable, as well as unique protocol-specific wire solutions
- Custom marking available

High availability, high-speed wire and cable for digital and RF applications—No minimum orders or minimum cable runs

Wire Type	Application	Commonly Used With
M22759 Single-Ended Data Transmission Wire	Non-impedance controlled signal applications	Non-shielded 39029 contacts
Quadrax Cable	10/100/1000BASE-T Ethernet applications	854-001/854-002 Quadrax contacts
Coaxial Cable	50 Ohm/75 Ohm RF transmission	Size #16, #12, #8 Coaxial pin and socket contacts
Protocol Specific Cables	Commercial digital data device connections including Ethernet, USB, SATA/eSATA, Spacewire, LVDS/CML	High Speed Mighty Mouse Mighty Mouse with Ultra-Twinax Differential Twinax contacts SuperSeal USB/RJ45

M22759 Hookup Wire
M22759/11 Silver Coated Copper Wire with Extruded PTFE Insulation
M22759/16 Tin Coated Copper Wire with Extruded ETFE Insulation
M22759/18 Tin Coated Copper Wire with Thin-Wall Extruded ETFE Insulation
M22759/32 Tin Coated Copper Wire with Crosslinked, Modified ETFE Insulation
M22759/33 Silver Coated Copper Wire with Crosslinked, Modified ETFE Insulation
M22759/34 Tin Coated Copper Wire with Overall Braid and Extruded ETFE Insulation
M22759/44 Silver Coated Copper Wire with Crosslinked, Extruded ETFE Insulation
M22759/45 Nickel Coated Copper Wire with Crosslinked, Extruded ETFE Insulation
M22759/46 Nickel Coated High Strength Copper Wire with Crosslinked, Extruded ETFE Insulation
M22759/90 Nickel Coated High Strength Copper Wire with Double Layer Tape Wrap Insulation

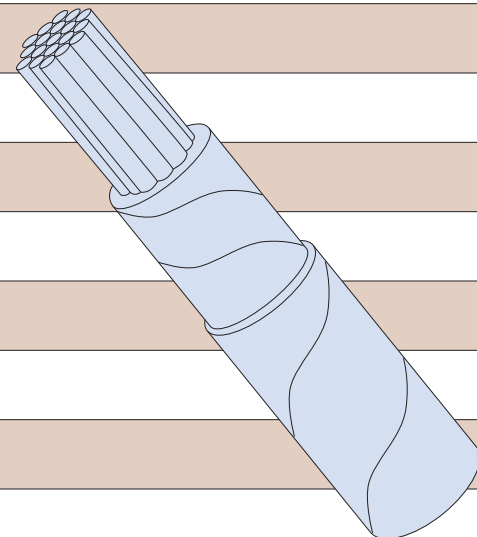

A

Quadrax Cable
963-019 100 Ohm Ethernet Cable with 22 AWG Conductors, FEP Jacket
963-020 100 Ohm Ethernet Cable with 24 AWG Conductors, FEP Jacket
963-021 100 Ohm Ethernet Cable with 26 AWG Conductors, FEP Jacket
963-022 100 Ohm Ethernet Cable with 24 AWG Conductors, FEP Jacket, Without PTFE Binder
963-023 100 Ohm Ethernet Cable with 24 AWG Conductors, ETFE Jacket
963-024 100 Ohm Ethernet Cable with 26 AWG Conductors, ETFE Jacket

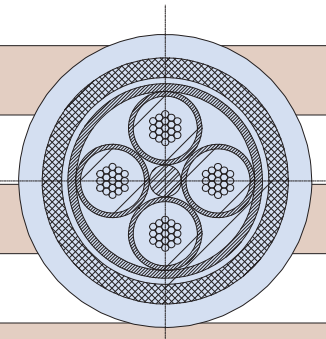

Coax Cable
962-001 TFlex® Low Loss Microwave 50 Ohm Coaxial Cable
962-002 M17/93 - RG178 General-Duty 50 Ohm High-Frequency Coaxial Cable with Extended Temperature Range
962-003 M17/94 - RG179 75 Ohm High-Frequency Coaxial Cable with Extended Temperature Range
962-004 M17/113 - RG316 Low-Loss 50 Ohm High Frequency Coaxial Cable with Extended Temperature Range
962-005 M17/152-00001 (RG316-DS) Double Shield 50 Ohm Coaxial Cable with Extended Temperature Range

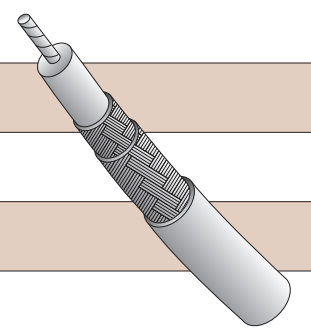

Protocol-Specific Cable
963-001 100 Ohm differential parallel pair data cable
963-002 1000 BASE-T Ethernet Cable with Polyurethane Jacket
963-003 10G BASE-T Ethernet Cable with FEP Jacket
963-004 10G BASE-T Ethernet Cable with PVC Jacket
963-005 USB 2.0 Cable with FEP, Polyurethane or No Jacket
963-012 USB 3.0 Cable with Polyurethane Jacket
963-006 110 Ohm Firewire Quad Cable with FEP, Polyurethane or No Jacket
963-013 100 Ohm SATA/eSATA Cable with Polyurethane Jacket
GWSM Glenair Spacewire Micro-D

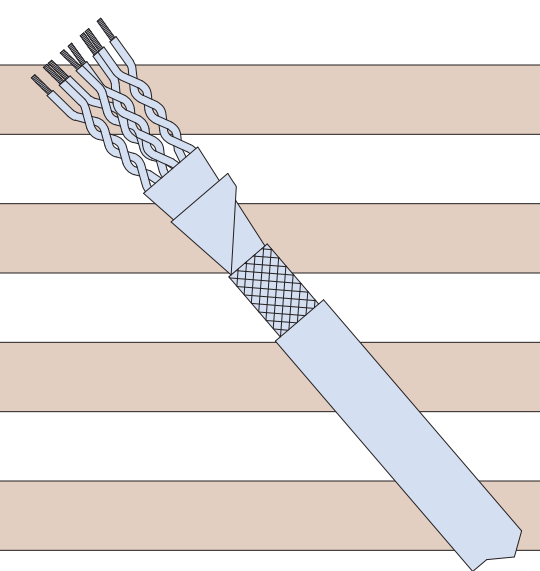



SERIES 80 MIGHTY MOUSE AND MORE

# Ultraminiature Circular Connectors

save weight • save space • enhance performance

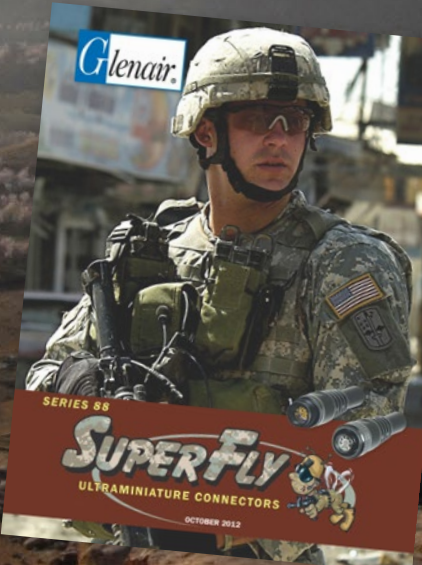
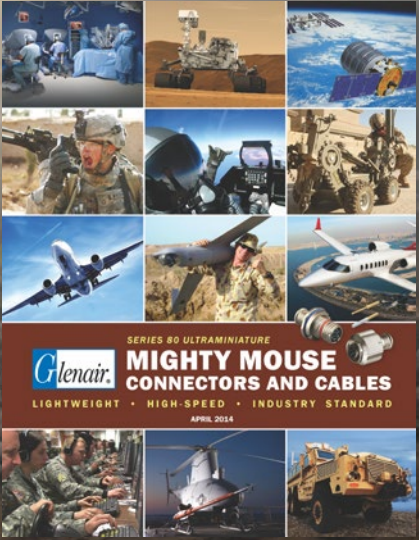
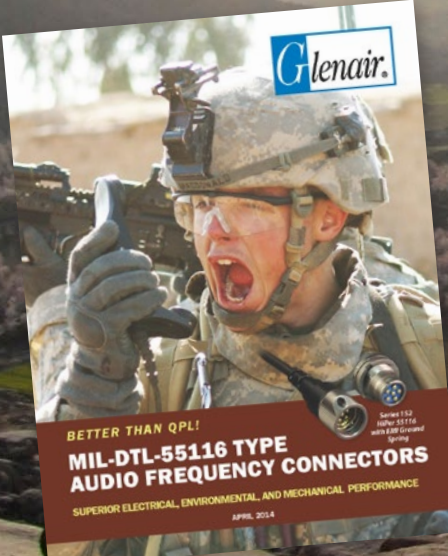

Ultraminiature Circular Connectors Selection Guide



Series 80 Mighty Mouse

Series 811 Mighty Mouse HD

Series 80 Mighty Mouse SuperSeal USB



Series 88 SuperFly™

HiPer 55116 Audio Frequency Connectors

Series 15 "CB" Audio Connectors

Glenair designs and manufactures the world's broadest and deepest selection of ultraminiature circular connectors for tactical field applications, reduced size and weight aerospace systems, mission-critical satellite payloads, robotic medical/surgical equipment and more. Our Series 80 Mighty Mouse has become a new industry standard—both in and outside the high-performance mil-aero marketplace—and is now used in numerous industrial applications as well. The Series 88 SuperFly™ is just our latest offering in our ultraminiature circular product family that continues to expand year-after-year to meet evolving requirements for small-form-factor I/O and board-level interconnects.



For more information contact Glenair at 818-247-6000 or visit our website at [www.glenair.com](http://www.glenair.com) U.S. CAGE code 06324



# SERIES 80 Mighty Mouse Connectors and Cables



# SERIES 80 Mighty Mouse Connectors and Cables



- 67 contact arrangements ranging from 1 – 130 contacts
- MIL-DTL-38999 caliber environmental, mechanical, and electrical performance
- Ultraminiature #23 contacts set on .076" centers
- Size #20, #20HD, #16, #12, #8 signal, power, fiber optic and shielded contacts
- Discrete connectors and turnkey cable assemblies



EMI/EMP filter-class connectors also available in every Mighty Mouse series

## Series 80 Mighty Mouse: Half the size and weight of MIL-DTL-38999 with comparable ratings, features, and performance

The Series 80 Mighty Mouse Connector is designed for use in high-reliability, mission-critical applications—from commercial aerospace to soldier systems—that require robust environmental and EMC performance as well as reduced size and weight. The Series 80 Mighty Mouse connector offers comparable performance to MIL-DTL-38999 interconnects with up to 71% weight and 52% size savings for similar contact layouts. The industry-standard Mighty Mouse is a mature connector series with a proven range of catalog and custom configurations.

### Series 80 Mighty Mouse Environmental Connectors

Series 800	Series 801	Series 802	Series 803	Series 804	Series 805
Light-Duty UNF Thread	Rugged Double-Start ACME Thread	3500 PSI AquaMouse	Fast-Mate Bayonet Coupling	Quick-Disconnect Push-Pull	Ratcheted Triple-Start

### Series 80 Mighty Mouse Hermetic Receptacles

Series 800	Series 801	Series 802	Series 803	Series 804	Series 805
•Vitreous glass sealing •1X10 <sup>-7</sup> cc/sec maximum helium leak rate		•Solder-cup and PC tail terminations •304L stainless steel shells		•Alloy 52 iron alloy contacts •Solder-mount, square flange or jam nut	

Series 80 Mighty Mouse Contact Arrangements													
Contact Size and Current Rating	Contact Quantity						Contact Arrangement*						
	#23	#20	#20HD	#16	#12	#8	Series 800	Series 801	Series 802	Series 803	Series 804	Series 805	
Size #23 Contacts 5 Amp Max. Current #22-#28 AWG  750 VAC DWV	3						5-3	5-3	5-3	5-3	5-3	N/A	
	4						6-4	6-4	6-4	6-4	6-4	8-4	
	6						6-6	6-6	6-6	6-6	6-6	8-6	
	7						6-7	6-7	6-7	6-7	6-7	8-7	
	10						7-10	7-10	7-10	7-10	7-10	9-10	
	13						8-13	8-13	8-13	8-13	8-13	10-13	
	19						9-19	9-19	9-19	9-19	9-19	11-19	
	26						10-26	10-26	10-26	10-26	10-26	12-26	
	31						N/A	11-31	N/A	N/A	11-31	13-31	
	37						12-37	13-37	12-37	12-37	12-37	15-37	
	55						N/A	16-55	14-55	14-55	14-55	18-55	
	85						N/A	17-85	15-85	N/A	N/A	19-85	
	100						N/A	19-100	N/A	N/A	N/A	21-100	
130						N/A	21-130	21-130	N/A	N/A	23-130		
Size #20HD Contacts 7.5 Amp Max. Current #20-#24 AWG  1000 VAC DWV		3					6-23	6-23	6-23	6-23	6-23	8-23	
		5					7-25	7-25	7-25	7-25	7-25	9-25	
		8					8-28	8-28	8-28	8-28	8-28	10-28	
		10					9-210	9-210	9-210	9-210	9-210	11-210	
		20					12-220	13-220	12-220	12-220	12-220	15-220	
		35					N/A	16-235	14-235	14-235	14-235	18-235	
		41					N/A	17-241	15-241	N/A	N/A	19-241	
		55					N/A	19-255	N/A	N/A	N/A	21-255	
		69					N/A	21-269	21-269	N/A	N/A	23-269	
	Size #16 Contacts 13 Amp Max. Current #16-#20 AWG  1800 VAC DWV			1				6-1	6-1	6-1	6-1	6-1	8-1
			2				8-2	8-2	8-2	8-2	8-2	10-2	
			4				9-4	9-4	9-4	9-4	9-4	11-4	
			5				10-5	10-5	10-5	10-5	10-5	12-5	
			7				12-7	13-7	12-7	12-7	12-7	15-7	
			12				N/A	16-12	14-12	14-12	14-12	18-12	
			14				N/A	17-14	15-14	N/A	N/A	19-14	
			19				N/A	19-19	N/A	N/A	N/A	21-19	
			22				N/A	21-22	21-22	N/A	N/A	23-22	
Size #12 Contacts 23 Amp Max. Current #12-#14 AWG  1800 VAC DWV					1			7-1	7-1	7-1	7-1	7-1	9-1
				2			10-2	10-2	10-2	10-2	10-2	12-2	
				2			12-2	13-2	12-2	12-2	12-2	15-2	
				3			12-3	13-3	12-3	12-3	12-3	15-3	
				5			N/A	16-5	14-5	14-5	14-5	18-5	
				7			N/A	17-7	15-7	N/A	N/A	19-7	
				12			N/A	21-12	21-12	N/A	N/A	23-12	
							N/A	21-12	21-12	N/A	N/A	23-12	
Size #8 Contacts 46 Amp Max. Current #8 AWG  1800 VAC DWV					1		N/A	8-1	N/A	N/A	N/A	10-1	
					2		N/A	16-2	N/A	N/A	N/A	18-2	
					3		N/A	17-3	N/A	N/A	N/A	19-3	
					4		N/A	19-4	N/A	N/A	N/A	21-4	
					5		N/A	21-5	N/A	N/A	N/A	23-5	
Combo Arrangements 750 VAC DWV	Size #23 and #12 Contacts	12				1	10-200	10-200	10-200	10-200	10-200	12-200	
		4				2	10-201	10-201	10-201	10-201	10-201	12-201	
		6				2	12-200	13-200	12-200	12-200	12-200	15-200	
		10				2	12-201	13-201	12-201	12-201	12-201	15-201	
		4			2		9-200	9-200	9-200	9-200	9-200	11-200	
	Size #23 and #16 Contacts	8			2		10-202	10-202	10-202	10-202	10-202	12-202	
		4	2				8-200	8-200	8-200	8-200	8-200	10-200	
		8	2				9-201	9-201	9-201	9-201	9-201	11-201	
		20			2		12-202	13-202	12-202	12-202	12-202	15-202	
		12			4		12-203	13-203	12-203	12-203	12-203	15-203	
Combo Arrangements 1300 VAC DWV	Size #23 and #16 Contacts	40			2		N/A	16-204	14-204	14-204	14-204	18-204	
		32			4		N/A	16-205	14-205	14-205	14-205	18-205	
		40			4		N/A	17-203	15-203	N/A	N/A	19-203	
		12				2	12-204	13-204	12-204	12-204	12-204	15-204	
		4			4		12-205	13-205	12-205	12-205	12-205	15-205	
	Size #23 and #12 Contacts	34			2		N/A	16-206	14-206	14-206	14-206	18-206	
		20			4		N/A	16-207	14-207	14-207	14-207	18-207	
		28			4		N/A	17-204	15-204	15-204	15-204	19-204	
		32					1	N/A	16-208	N/A	N/A	N/A	18-208
		40					1	N/A	17-205	N/A	N/A	N/A	19-205
Size #23 and #8 Contacts	44				2	N/A	19-201	N/A	N/A	N/A	21-201		
	12				4	N/A	19-202	N/A	N/A	N/A	21-202		
	28				4	N/A	21-200	N/A	N/A	N/A	23-200		

\* DWV rating is applicable to contact arrangements shown.





SERIES 824

# Mighty Mouse

## LOCKING PUSH-PULL CONNECTORS

Introducing the new Mighty Mouse Series 824 Locking Push-Pull Connector: all the familiar size, weight and performance advantages of the industry-standard Mighty Mouse 804 push-pull connector with a revolutionary low-profile locking coupling mechanism. Glenair's primary design goal in the development of the locking 824 was to bring mil-spec caliber connector performance to locking push-pull applications. The Series 824 Locking Push-Pull provides superior sealing, excellent EMI protection, low-profile ergonomic mating and demating, and easy crimp contact termination. The locking push-pull mechanism delivers visual, tactile, and audible mating confirmation under even the most extreme field conditions. Built for long-term durability and reduced size and weight, the high-density Series 824 Locking Push-Pull connector far surpasses commercial caliber push-pull connectors.

Specifications	
Current Rating	#23 5 AMPS, #16 13 A., #12 23 A.
Dielectric Withstanding Voltage	#23 500 VAC RMS, #12 and #16 1800 VAC RMS
Insulation Resistance	5000 megohms minimum
Operating Temperature	-65° C to +150° C
Shock / Vibration	100 g / 16 g
Shell-to-Shell Resistance, Nickel Plated	2 milliohms maximum
Durability	500 mating cycles
Breakaway Force	50 pounds minimum

Gold plated crimp contacts for #12 to #30 AWG wire



- Fast mating, quick-release coupling mechanism
- 31 insert arrangements
- Integrated cable shield termination platform



For more information contact Glenair at **818-247-6000** or visit our website at [www.glenair.com](http://www.glenair.com)

SERIES 824

# Mighty Mouse

## LOCKING PUSH-PULL CONNECTORS

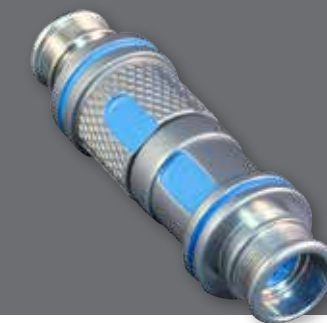

How To Order Series 824 Locking Push-Pull Plug						
Sample Part Number	824-001	-06	M	8-1	P	A
Product Series	824-001 Mighty Mouse Locking Push-Pull cable plug with integrated shield termination platform					
Shell Style	-06 - Plug					
Shell Material/Finish	See Table II					
Shell Size/Contact Arrangement	See Table I					
Contact Type	Connector supplied with contacts: P - Pin S - Socket			Connector supplied without contacts: A - Pin B - Socket		
Shell Key Position	Omit for single polarizing key. A (normal), B, C, D, E, F polarizing options per Table III					

How To Order Series 824 Locking Push-Pull Receptacle						
Sample Part Number	824-003	-01	M	8-1	P	A
Product Series	824-003 Mighty Mouse Locking Push-Pull cable receptacle with integrated shield termination platform					
Shell Style	-01 - In-Line -07 - Rear-Panel Jam Nut Mount -00 - Front-Panel Jam Nut Mount					
Shell Material/Finish	See Table II					
Shell Size/Contact Arrangement	See Table I					
Contact Type	Connector supplied with contacts: P - Pin S - Socket			Connector supplied without contacts: A - Pin B - Socket		
Shell Key Position	Omit for single polarizing key. A (normal), B, C, D, E, F polarizing options per Table III					

Table III: Alternate Key Positions		
Position	A°	B°
A	150°	210°
B	45°	210°
C	45°	230°
D	140°	315°
E	150°	315°

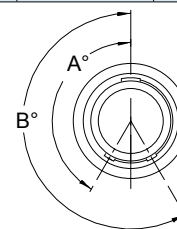

Table II: Material and Finish	
M	Aluminum/Electroless Nickel RoHS Compliant
NF	Aluminum/Cadmium with Olive Drab Chromate
ZR	Aluminum/Zinc-Nickel with Non-Reflective Black Chromate RoHS Compliant
MT	Aluminum/Nickel-PTFE RoHS Compliant
Z1	Stainless Steel/Passivated RoHS Compliant

### MATERIAL/FINISH

Barrel: Copper Alloy  
Shell/Release Sleeve: Aluminum Alloy or CRES  
Insulators: Liquid Crystal Polymer  
Interfacial Seal, O-Ring, Grommet: Fluorosilicone  
Contacts: Copper Alloy/Gold over Nickel Plating  
Spring: CRES/Gold Plated

Table I: Contact Arrangements					
Contact Arr.	No. of Contacts				
	#23	#20	#20HD	#16	#12
5-3	3				
6-1				1	
6-23			3		
6-4	4				
6-6	6				
6-7	7				
7-1					1
7-25			5		
7-10	10				
8-2				2	
8-28			8		
8-13	13				
8-200	4	2			
9-4				4	
9-210			10		
9-19	19				
9-200	4			2	
9-201	8	2			
10-2					2
10-5				5	
10-26	26				
10-200	12				1
10-201	4				2
10-202	8			2	
12-2					2
12-3					3
12-7				7	
12-220			20		
12-37	37				
12-200	6				2
12-201	10				2



For more information contact Glenair at **818-247-6000** or visit our website at [www.glenair.com](http://www.glenair.com)





# MIGHTY MOUSE Cobra

## The ultra-low profile EMI/RFI plug and backshell assembly

Innovative shielded low profile right angle connector plug and backshell assemblies reduce clearance requirements without compromising ruggedness or shielding performance. Available in Series 801 double-start, Series 804 QDC push-pull, and Series 805 triple-start, Cobra assemblies provide optimal low-profile cable routing and legendary Mighty Mouse connector performance in a single package. Each Cobra assembly is equipped with a removable rear cover and gasket for easy crimp or solder contact termination of the connector. Integrated low-profile backshell is equipped with an EMI/RFI shield termination platform and a shrink boot lip. The ultra-lightweight assembly may be clocked in eight different angle orientations for additional flexibility in cable routing. Connectors are equipped with polarization keying to prevent mismatching. Glenair Mighty Mouse Cobra mates with available square flange and jam nut receptacles from each respective connector series. Fourteen contact arrangements are available, all with Size #23 contacts from shell size 5 to shell size 21 with 3-130 contacts respectively. Connector shells are aluminum alloy or stainless steel.

### SPECIFICATIONS

- Current Rating: #23 5 Amps
- Test Voltage (DWV) #23: 500 VAC Sea Level
- Insulation Resistance: 5000 megohms minimum
- Contact Resistance: 73 millivolt drop at 5 Amp test current
- Mating Cycles Series 801 and 804: 2000; Series 805: 500
- Operating Temperature: -55° C to +150° C
- Shielding Effectiveness: 50 dB min from 100MHz to 1000MHz.
- Magnetic Permeability: 2.0μ
- Vibration: 37g / Shock: 300g
- Immersion, mated: 1meter water immersion for 1 hour



■ **Space-saving design features one-piece machined and brazed connector shell and right angle backshell for minimum height and optimal EMI performance.**

■ **Master key clocking enables easy cable entry/exit routing in eight angles**

■ **Removable rear cover and gasket provides easy access to end of connector for crimp or solder contact termination**

## MIGHTY MOUSE Low-Profile Cobra Plug Connectors

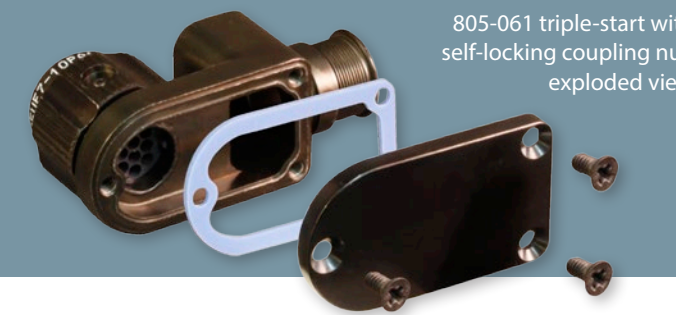

805-061 triple-start with self-locking coupling nut, exploded view

How To Order Mighty Mouse Cobra Plug Connector and Backshell Assemblies						
Sample Part Number	801-069-26	ZNU	8-13	P	A	1 05
Connector Series and Mighty Mouse Cobra Basic Part Number	801-069-26 Double-Start self-locking plug with ratchet mechanism (the clicker) 804-066-06 QDC Push-Pull plug 805-061-16 Triple-Start plug with ratcheting anti-decoupling mechanism					
Material/Finish	M = Aluminum / Electroless Nickel RoHS Compliant NF = Aluminum / Cadmium with Olive Drab Chromate ZNU = Aluminum / Zinc-Nickel with Black Chromate MT = Aluminum / Nickel-PTFE RoHS Compliant ZI = Stainless Steel / Passivated RoHS Compliant					
Shell Size - Contact Arrangement	See Table V - A: 801-069 B: 804-066 C: 805-061					
Contact Style	A = Pin, Solder B = Socket, Solder P = Pin, Crimp S = Socket, Crimp					
Polarization Key Position	A, B, C, D, E, F - See Table II					
Cable Exit Direction	1, 2, 3, 4, 5, 6, 7, 8 - See Table I					
Cable Entry Size	See Table VI					

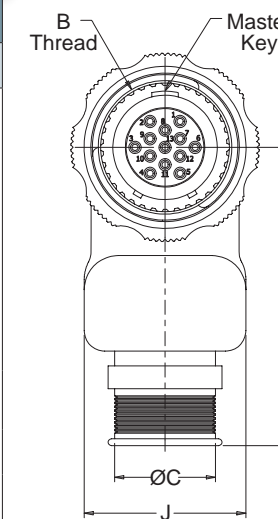

Table I: Cable Exit Direction	
Cable Exit Direction Code	C°
1	0°
2	45°
3	90°
4	135°
5	180°
6	225°
7	270°
8	315°

Table II: Key Positions		
	A°	B°
A	150°	210°
B	75°	210°
C	95°	230°
D	140°	275°
E	75°	275°
F	95°	210°

Table VI - Cable Entry			
Code	Entry Size	Code	Entry Size
02	.125	10	.625
03	.188	11	.688
04	.250	12	.750
05	.313	13*	.813
06	.375	14*	.875
07	.438	15*	.938
08	.500	16*	1.000
09	.563	17*	1.063

\* Entry codes 13-17 not available for Series 804 Cobra

Table V - Shell Size/Contact Arrangements								
A: 801-069			B: 804-066			C: 805-061		
Shell Size	Contact Arr.	Max Entry	Shell Size	Contact Arr.	Max Entry	Shell Size	Contact Arr.	Max Entry
5	5-3	03	5	5-3	03	8	8-4, 8-6, 8-7	04
6	6-4, 6-6, 6-7	04	6	6-4, 6-6, 6-7	04	9	9-10	05
7	7-10	05	7	7-10	05	10	10-13	06
8	8-13	06	8	8-13	06	11	11-19	07
9	9-19	07	9	9-19	07	12	12-26	08
10	10-26	08	10	10-26	08	13	13-31	09
11	11-31	09	12	12-37	10	15	15-37	10
13	13-37	10	14	14-55	12	18	18-55	12
16	16-55	12				19	19-85	13
17	17-85	13				21	21-100	15
19	19-100	15				23	23-130	17
21	21-130	17						

### MATERIALS/FINISH

- Contacts: Copper alloy, gold plated
- Backshell Housing, Connector Shell, Coupling Nut and Lid: Aluminum or Stainless Steel
- Backshell Sealing Gasket and Interfacial Seal: Fluorosilicone
- Screws: 300 Series Stainless Steel
- Insulator: LCP

### NOTES

- Rear insulator grommet not supplied.
- Cobra plugs mate with respective series receptacles with same layout, polarization and opposite contact gender.
- Hand crimp tool: P/N 809-015. Positioner for hand tool: P/N 809-005. Insertion/extraction tool P/N 809-088.
- Crimp barrel accommodates 22, 24, 26 and 28 gage wire.
- All Cobra plugs equipped with Size #23 contacts.





Fluoropolymer PFA Insulators • Ultra-Twinax  
Size #8 Quadrax/Twinax • Size #8 El Ochito®

## Mighty Mouse High-Speed and Ultra-Twinax connectors: rugged environmental sealing and high-speed matched impedance electrical performance in an ultraminiature package



Combine Mighty Mouse with—or even eliminate—low-performance commercial high-speed connectors

Glenair Series 80 Mighty Mouse connectors are the new industry standard for high-performance ultraminiature connectors. Now Glenair expands the Mighty Mouse line to include connectors optimized for high-speed matched impedance performance. The Mighty Mouse High-Speed product line features Fluoropolymer insulators for superior electrical performance in protocol-specific applications such as eSATA and USB 2.0/3.0.

Mighty Mouse Ultra-Twinax connectors utilize size #12 Twinax contacts for ultra-high speed differential pair applications such as LVDS and CML.

### MIGHTY MOUSE HIGH-SPEED



Series 80 Mighty Mouse High Speed Connectors with Fluoropolymer PFA Insulators

- For high-speed protocols: eSATA, 10GBASE-T, USB 2.0 / 3.0
- Fluoropolymer PFA insulators for superior insertion loss and balanced impedance
- Series 801 double-start ACME thread and Series 804 push-pull quick disconnect connectors available
- Discrete components or overmolded cordsets

### MIGHTY MOUSE ULTRA-TWINAX



Series 80 Mighty Mouse Ultra-Twinax Connectors with Size #12 Twinax contacts

- For ultra high-speed differential pair applications: LVDS, CML
- Size #12 Twinax and hybrid contact arrangements
- Series 801 double-start ACME thread connectors
- Discrete components or overmolded cordsets
- Frequency range from DC to 10GHz

### MIGHTY MOUSE WITH SIZE #8 QUADRAX, EL OCHITO® AND DIFFERENTIAL TWINAX CONTACTS



Series 805 Mighty Mouse plug with size 8 Quadrax contacts

- Differential Twinax contacts for 100 Ohm serial data transmission
- Quadrax contacts for 100BASE-T Ethernet
- Arrangements for 1, 2, 3, 4 or 5 snap-in, rear-release contacts
- Lightweight, low profile
- Comprehensive range of assembly tooling
- Available for Series 801 (double-start) and 805 (triple-start) Mighty Mouse connectors
- El Ochito®: the ultimate ethernet contact



Fluoropolymer PFA Insulators • Ultra-Twinax  
Size #8 Quadrax/Twinax • Size #8 El Ochito®

This table compares contact and wire spacing and bandwidth performance in miniaturized interconnect applications. As contact density increases, the performance of the interconnect improves. Note the position of the High-Speed and Size #8 Mighty Mouse compared to standard Mighty Mouse, and the position of the Ultra-Twinax Mighty Mouse with performance up to 10 GHz. The density of the Ultra-Twinax contacts is measured between the two components in each contact—so although the #12 contact is larger overall, the effective contact density is higher.

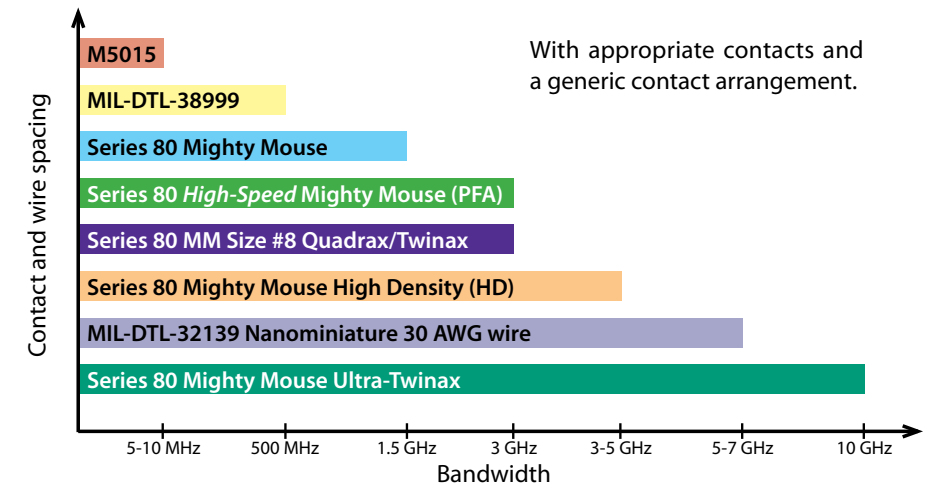

### Mighty Mouse High Speed Contact Arrangements Mating Face View of Pin Connector (Socket Connector Numbers are Reversed)



6 - 4

Shell Size 6  
4 Size #23 Contacts

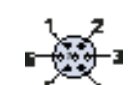

6 - 7

Shell Size 6  
7 Size #23 Contacts



7 - 10

Shell Size 7  
10 Size #23 Contacts

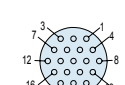

9 - 19

Shell Size 9  
19 Size #23 Contacts

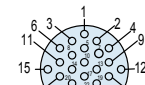

10 - 26

Shell Size 10  
26 Size #23 Contacts

### Mighty Mouse Ultra Twinax Size #12 Differential Twinax Contact Arrangements (Mating Face/Pin Connector)



7-1

Shell Size 7  
1 Size #12  
Twinax Contact



10-2

Shell Size 10  
2 Size #12 Twinax  
Contacts



16-5

Shell Size 16  
5 Size #12 Twinax  
Contacts



17-7

Shell Size 17  
7 Size #12 Twinax  
Contacts



21-12

Shell Size 21  
12 Size #12 Twinax  
Contacts



10-201

Shell Size 10  
2 Size #12 Twinax  
Contacts



10-200

Shell Size 10  
1 Size #12 Twinax  
Contact

### Mighty Mouse #8 Quadrax / Differential Twinax, and El Ochito® Contact Arrangements

Mating Face



Series 801

Shell Size 8  
1 Size #8 Contact



Shell Size 10  
2 Size #8 Contacts



Shell Size 17  
3 Size #8 Contacts



Shell Size 19  
4 Size #8 Contacts



Shell Size 21  
5 Size #8 Contacts

Series 805

Shell Size 10  
1 Size #8 Contact

Shell Size 18  
2 Size #8 Contacts

Shell Size 19  
3 Size #8 Contacts

Shell Size 21  
4 Size #8 Contacts

Shell Size 23  
5 Size #8 Contacts



SERIES 811  
Mighty Mouse High Density (HD)  
Connectors and Cables



SERIES 811  
Mighty Mouse High Density (HD)  
Connectors and Cables

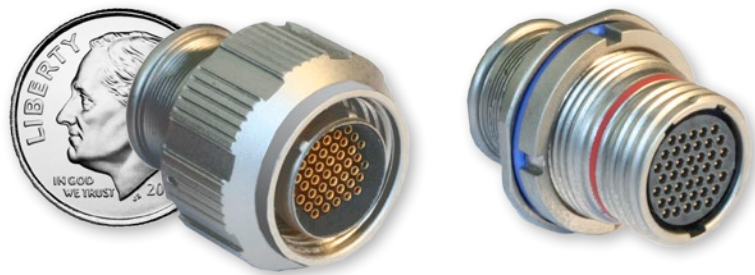

811-001-06ME9-42SA  
Series 811 Plug

811-003-07ME9-42PA  
Series 811 Receptacle

- High Density Micro TwistPin Contacts set on .050" centers deliver over twice the density of standard Series 80 Mighty Mouse
- 7 to 42 Contacts
- Water Resistant to 1 meter
- Double-start ACME threaded coupling

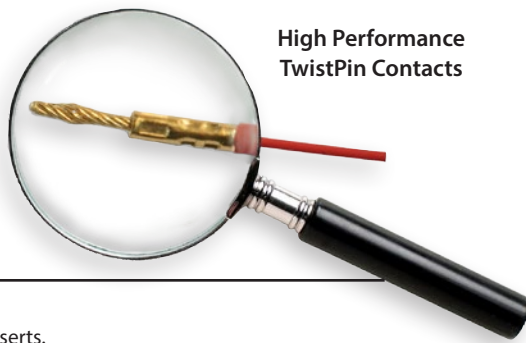

High Performance  
TwistPin Contacts

Mighty Mouse high density (HD) connector delivers twice the size and weight savings compared to standard Mighty Mouse

SERIES 811 MIGHTY MOUSE HD CONTACT ARRANGEMENTS

Pin insert shown, use reverse order for socket inserts.

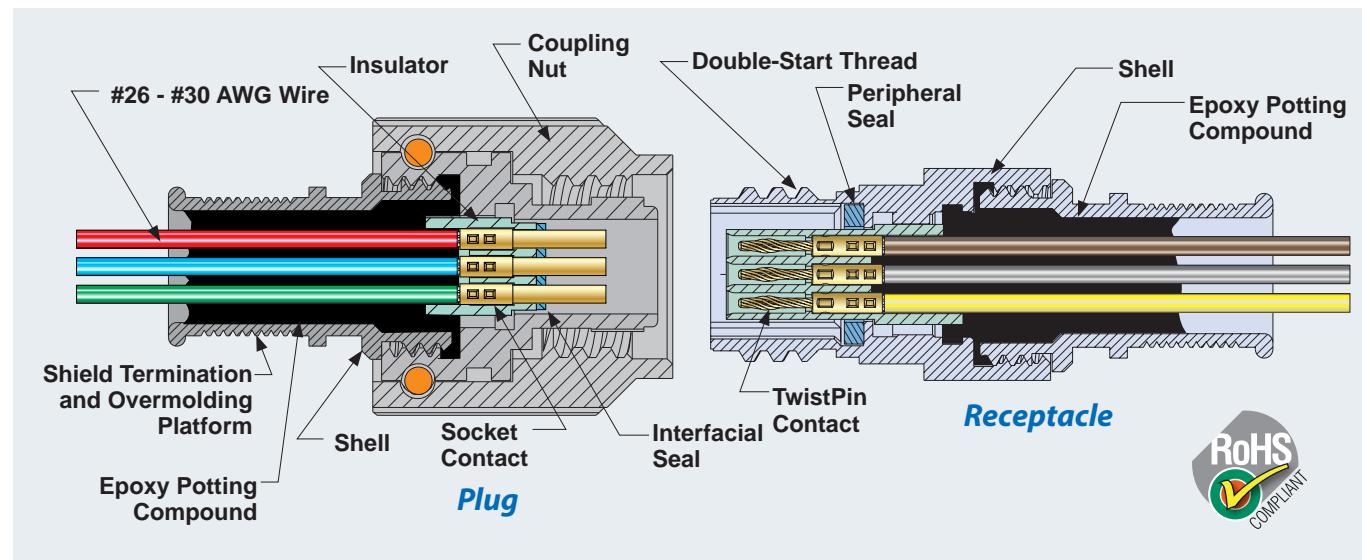
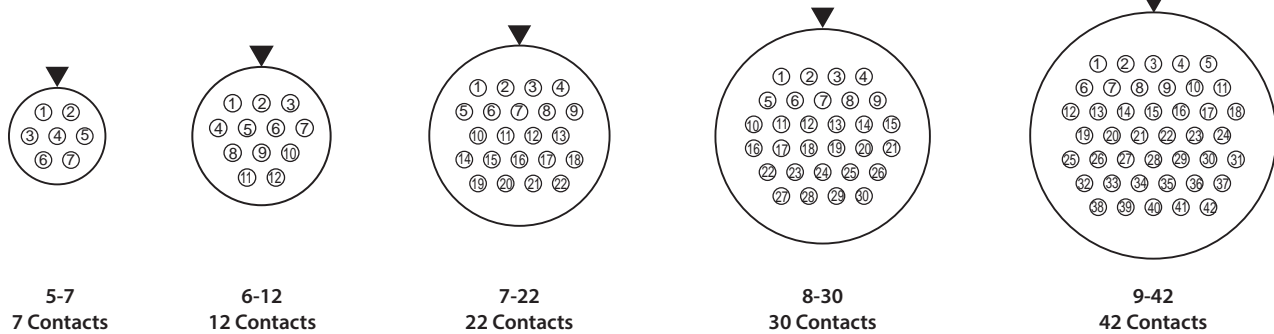

The 811 HD Difference: Micro TwistPin Contacts

Widely used for radars, missiles, avionics, and space vehicles, the Micro TwistPin is a spring pin composed of helically wound strands of copper alloy wire, welded into a bundle, then "bulged" and crimped to a copper alloy sleeve. These gold over nickel plated pins and sockets offer low, stable contact resistance even when subjected to temperature extremes and vibration. Designers of soldier systems and other military electronics, medical and high-end industrial equipment have all turned to the TwistPin contact in order to reduce the size and weight of high-performance systems.

Specifications	
Current Rating	3 AMPS
Dielectric Withstanding Voltage	600 VAC sea level, 150 VAC at 70,000 ft.
Insulation Resistance	5000 megohms minimum
Operating Temperature	-65° C. to +150° C.
Contact Resistance	8 milliohms maximum
Water Immersion, Mated	MIL-STD-810G, Method 512.5.1 meter for 1 hour
Water Ingress, Mated	Ingress protection 67
Shock	300 g's (MIL-DTL-38999 para. 4.5.21.1)
Vibration, Sine	60 g's (MIL-DTL-38999 para. 4.5.23.2.1)
Vibration, Random	23 g's (MIL-DTL-38999 para. 4.4.23.1)
Altitude-Low Temperature	EIA-364-105
Durability	2000 cycles of mating
Magnetic Permeability	2 μ maximum
Shielding Effectiveness	55 dB minimum from 100MHz to 1000MHz.

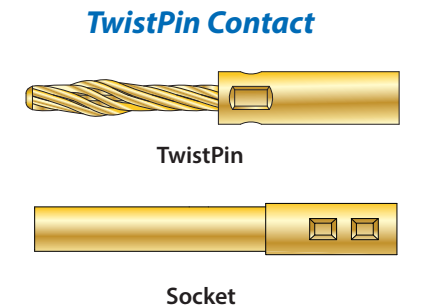

Protective Covers



SERIES 811 MIGHTY MOUSE HD: PRE-WIRED CONNECTORS

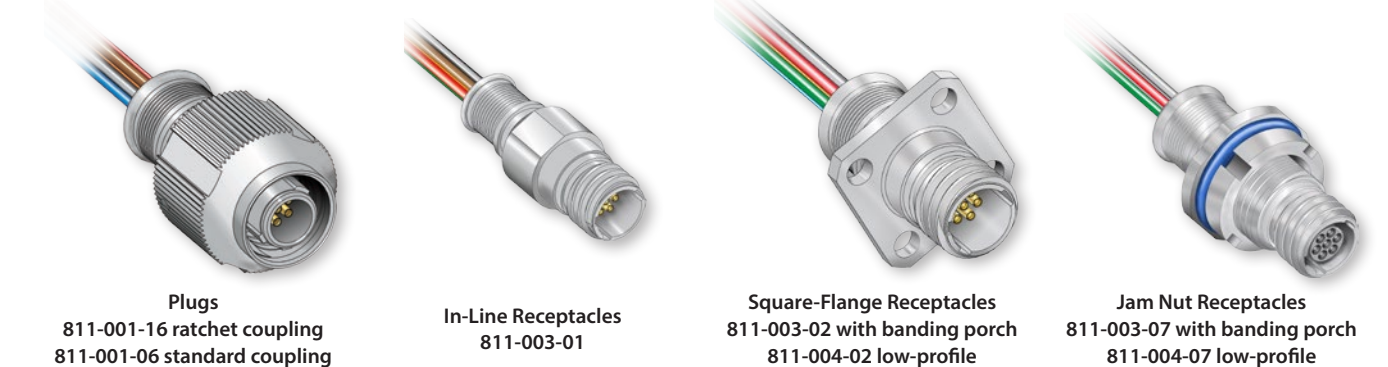

SERIES 811 MIGHTY MOUSE HD: PC TAIL CONNECTORS





# ULTRAMINIATURE SERIES 80 USB SuperSeal™ Small Form-Factor Connectors



# ULTRAMINIATURE SERIES 80 USB SuperSeal™ Small Form-Factor Connectors



Series 801 Mighty Mouse Plug and Receptacle with SuperSeal® Micro-B USB

- Significant size and weight reduction compared to MIL-DTL-38999 type USB/RJ45 solutions
- Rear-release crimp contact termination as well as USB/RJ45 jumper accommodation
- Superior sealing, IP67, in unmated condition compared to other available environmental circulars
- Superior grounding for electrostatic discharge and EMC
- Superior cable shield termination with integrated banding platform
- Optional spring-loaded protective covers for environmental protection of junction boxes and switches
- Wide range of high speed Ethernet/network protocols supported, including USB 2.0

Crimp contact micro-USB connectors with outstanding environmental performance and EMI/RFI grounding. Smallest form-factor high-performance solution for integration of the commercial USB interface

Test Description	Mighty Mouse USB Performance Requirements/Specifications	Procedure Per MIL-DTL-38999 or Other Standard
Dielectric withstanding voltage	Maximum leakage current = 2 milliamperes No evidence of electric breakdown or flashover	4.5.11.1 or 4.5.11.2 IAW EIA-364-20, Method A
Insulation resistance	At ambient temperature: >5000 megohms between any pair of contacts and between any contact and the shell. after altitude immersion = 1000 megohms min. after humidity = 100 megohms min. At elevated temperature: >1000 megohms	4.5.10.1 and 4.5.10.2 IAW EIA-364-21
Contact resistance	Terminal-to-terminal resistance of vd connector contacts shall not exceed 0.050 ohms.	4.5.14
Mating durability	500-1000 cycles depending on plating, with no mechanical damage. Dielectric, contact resistance and air pressure requirements as described above shall be met after 500-1000 mating cycles.	4.5.8
Contact retention	Individual contacts capable of withstanding at least 10 pounds axial load applied uniformly at one pound per second.	IAW EIA-364-29
Vibration and Shock	37 g's random vibration, 300 g's shock. No electrical discontinuity, no disengagement of mated connectors, backing off of the coupling mechanism, or evidence of cracking, breaking, or loosening.	4.5.23
Temperature cycling	-65°C to 175°C or 200°, depending on finish. No blistering, peeling or separation of plating or other damage detrimental to the operation of the connector.	4.5.4 EIA364-32, Test cond. A
Salt spray	5% solution, 34°-36°C. 48-1000 hours, depending on finish. Unmated connectors show no lifting of plated coating or exposure of basis material under 3X magnification which adversely affects performance.	4.5.13 EIA-364-26
Humidity	Cycle wired, mated connectors between 25 °C at 80 % and 65 °C at 50 %. Ramp time = 0.5 hour, dwell = 1.0 hour. 24 cycles.	4.5.26 EIA364-31, Method IV
Water immersion	1 Meter for 1 Hour, mated.	MIL-STD-810 Method 512
EMI Shielding	Series 801: Good • Series 804: Very Good • Series 805: Excellent	4.5.28 EIA-364-66

## SUPERSEAL™ MIGHTY MOUSE MICRO-B USB CONNECTOR SELECTOR



Series 801 Plug Connector with Micro-B USB



Series 801 In-Line Receptacle



Series 801 Square Flange Mount Receptacle



Series 801 Rear Panel Jam Nut Mount Receptacle



Series 804 Plug Connector with Micro-B USB



Series 804 In-Line Receptacle



Series 804 Rear Panel Jam Nut Mount Receptacle



Series 804 Front Panel Jam Nut Mount Receptacle



Plug-and-Play Micro-USB Plug and Receptacle

Plug-and-Play Micro-USB Booted Cordset



Spring-Loaded cover for Series 804 Jam Nut Receptacles

### Crimp Contact Pin Layout

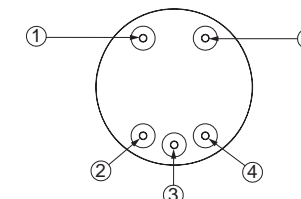

Pin Number	USB Designation	Typical Wiring Assignment
1	VBUS	Red
2	D-	White
3	D+	Green
4	ID	RA_PLUG_ID
5	GND	Black
Shell	SHIELD	DRAIN WIRE

### MATERIAL AND FINISHES

- Shell/coupling: High strength aluminum alloy
- Plating: Cadmium olive drab over electroless nickel; Nickel PTFE; Electroless nickel
- Contacts: Copper alloy, gold plated
- USB insulator: LCP
- Seals: Silicon-based elastomer
- Stainless steel and other materials and finishes available. Please consult factory.

### MICRO USB ELECTRICAL SPECIFICATIONS

- Voltage Rating: 30 VAC (rms)
- Current Rating: Signal pins 1.0A, Power pins 1.8A
- D.W.V.: 600 VAC
- Shield Continuity: Continuous through coupler or continuous coupler to shell





SERIES 88  
SuperFly® Ultraminiature  
Connectors and Cordsets



SERIES 88

# SuperFly®: the ultimate nanominiature tactical connector

The ultimate high-performance connector series: ready for the toughest (and smallest!) applications you've got

Glenair Series 88 SuperFly® represents a perfect storm of high-performance contacts, shells, wires, termination and mating technologies. SuperFly® is the only connector series in existence that combines the weight-saving and performance advantages of nanominiature, microminiature and AS39029 type (size #23) contacts in a precision package made to order for battlefield and other high-performance applications. Available in factory-terminated cordsets, single-ended pigtailed, and discrete PCB termination receptacles for complete flexibility in cable and box configurations. SuperFly cordsets ship with ultra-flexible, high-speed GhostWire™ cabling, your choice of threaded or quick disconnect coupling and a wide-range of contact arrangements from 3–44 contacts. PCB receptacles are available in straight and right-angle configurations.



Rear-panel mount push-pull and threaded PCB receptacles now available

**SUPPORTED CONTACTS**

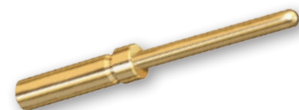

#23 AS39029 Type 5 Amp Crimp Contact



#24 Micro-D 3 Amp TwistPin Contact



#30 Nano-D 1 Amp TwistPin Contact

**ULTRAMINIATURE SUPERFLY® CORDSETS AND PIGTAILS**



Overmolded threaded plug and receptacle



Threaded pigtail plug and receptacle



Quick-disconnect overmolded cordset

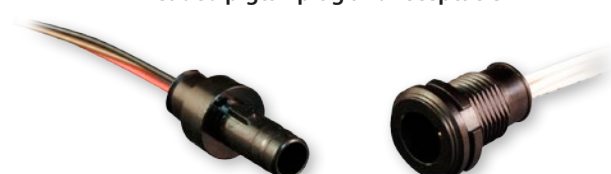

Quick-disconnect pigtail plug and jam nut receptacle

- IP67 immersion rated
- High-reliability contacts: 5 Amp, 3 Amp, and 1 Amp
- High shock and vibration
- Robust EMI shielding
- Designed for high speed data applications

- Pre-wired, epoxy-sealed cordsets
- Straight and right-angle PC tail receptacles
- 21 Contact arrangements
- Front or rear panel mounting
- Aluminum or stainless steel
- Accepts #22 to #32 AWG wire

SuperFly® Layouts Arranged by Protocol					
Layout	Protocol(s)	Layout	Protocol(s)	Layout	Protocol(s)
B-7N	eSATA/SATA	E-4M4N	Ethernet PoE	H-6W14N	HDMI (3 extra)
C-10N	USB 3.0 (low power) Ethernet	F-22N	HDMI (3 extra) DisplayPort (2 extra)	J-44N	
C-2M2N	USB	F-4W4N	Ethernet PoE	J-7W19N	HDMI (7 extra) Camera Link
D-3M		G-7W	eSATA/SATA	K-19M	HDMI
D-2W2N	USB	G-10M	USB 3.0 Ethernet (2 extra)	K-13M19N	HDMI (13 extra)
E-3W		H-10W	USB 3.0 Ethernet (2 extra)	L-22M	HDMI (3 extra) DisplayPort (2 extra)
E-19N	HDMI	H-37N			

Contact Arrangements										
5 AMP		COMBO 5 AMP & 1 AMP		3 AMP		COMBO 3 AMP & 1 AMP		1 AMP		
E3W (3) 5A	G7W (7) 5A	D2W2N (2) 5A, (2) 1A	F4W4N (4) 5A, (4) 1A	D3M (3) 3A	G10M (10) 3A	C2M2N (2) 3A, (2) 1A	E4M4N (4) 3A, (4) 1A	B7N (7) 1A	C10N (10) 1A	E19N (19) 1A
H10W (10) 5A	H6W14N (6) 5A, (14) 1A	J7W19N (7) 5A, (19) 1A	K19M (19) 3A	L22M (22) 3A	G6M10N (6) 3A, (10) 1A	K13M19N (13) 3A, (19) 1A	F22N (22) 1A	H37N (37) 1A	J44N (44) 1A	





SERIES 152 HIGH PERFORMANCE  
MIL-DTL-55116 Type High-Performance  
Audio Frequency Connectors



SERIES 152 • MIL-DTL-55116 TYPE  
**HiPer 55116**  
**Audio Frequency Connectors**

Series 152 HiPer 55116 connectors offer significant performance advantages for modern soldier communication systems

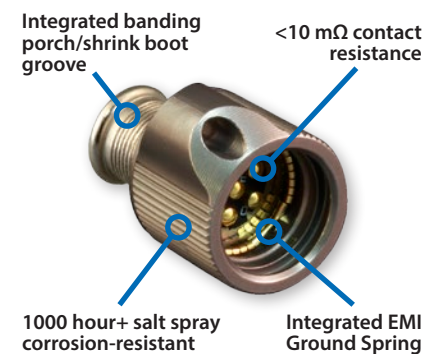

Fully intermateable and interoperable with MIL-DTL-55116 connectors

- Intermateable and interoperable with standard MIL-DTL-55116 connectors
- Low contact resistance: less than 10 milliohms
- Integrated EMI ground spring provides improved 2.5 milliohm shell-to-shell conductivity performance
- IP68 rated sealing in mated and unmated condition, prevents water ingress into radio equipment
- 1,000 hour+ salt spray corrosion resistance
- Integrated cable shield termination band porch
- Superior 100 pound cable pull test rating

Series 152 HiPer 55116 Selection Guide			
Part Description	Glenair P/N	Equivalent Mil P/N, "U" designator	Mates with
Audio plug, field serviceable, with wire strain relief and rigid contacts	152-001	M55116/1 - /4 type U-229	152-003 HiPer 55116 type jam nut receptacle 152-004 HiPer 55116 type in-line receptacle 151-003 standard 55116 type jam nut receptacle 151-004 standard 55116 type in-line receptacle any M55116 receptacle
Overmolded audio plug cordset with wire strain relief	152-006		
Audio plug with shield termination porch, overmolding adapter and rigid contacts	152-002	M55116/5 - /8 type U-229	152-003 HiPer 55116 type jam nut receptacle 152-004 HiPer 55116 type in-line receptacle 151-003 standard 55116 type jam nut receptacle 151-004 standard 55116 type in-line receptacle any M55116 receptacle
Overmolded audio plug cordset	152-005		
In-line receptacle with shield termination porch, overmolding adapter, and non-rigid spring contacts	152-004	M55116/5 - /8 type U-229	152-003 HiPer 55116 type jam nut receptacle 152-004 HiPer 55116 type in-line receptacle 151-003 standard 55116 type jam nut receptacle 151-004 standard 55116 type in-line receptacle any M55116 receptacle
Overmolded in-line receptacle cordset	152-007		
Radio-mount jam nut receptacle with non-rigid spring contacts	152-003	M55116/9 - /10 type U-183	152-001 HiPer 55116 type plug 152-002 HiPer 55116 type plug 151-001 standard 55116 type plug 151-002 standard 55116 type plug any M55116 plug

Series 152 HiPer 55116 Performance Specifications	
Complies with all MIL-DTL-55116 specifications and exceeds the following performance criteria:	
Shell-to-shell conductivity	152-001 and -002 Plugs: 2.5 milliohms max. 152-003 receptacle: 2.5 milliohms max when mated to Glenair HiPer 55116 plug 152-001 or -002
Cable shield-to-shell conductivity	2.5 milliohms max.
Contact resistance (mated)	15 milliohms max. average; 20 milliohms max.
Water immersion (mated & un-mated)	152-002 plug, 152-003 receptacle: IP68 (10 meters of standing water for 1 hour)
Air Pressure	15 psi
Salt spray	1,000 hours (MIL-STD-202, Method 101E)
Cable pull-out force (unmated)	152-001 and -002 plugs: 100 lbs. (Cable shield strength dependent)
All other performance characteristics of Series 152 HiPer 55116 connectors are compliant with MIL-DTL-55116 (see table on Page 11 for specifications)	

B



SERIES 151 HIGH PERFORMANCE  
MIL-DTL-55116 Type  
Audio Frequency Connectors



High reliability performance  
for mission-critical communication systems

The MIL-DTL-55116 audio frequency connector has been used in tactical radio systems for generations. Now, this reliable, field-cleanable interconnect has been specified for use in the Joint Tactical Radio System—the next generation voice and data radio for U.S. military field operations, ensuring its continued use and service to soldiers, sailors and airmen. The Glenair MIL-DTL-55116 Type connector is manufactured in our Glendale, California factory with materials and processes guaranteed to result in the best performing and most reliable connector system available. Best of all, these products—from crimp and solder termination cable plugs, to ruggedized and sealed receptacles are in-stock and available for immediate, same-day shipment.

Series 151 standard version offers performance IAW MIL-DTL-55116

Test Description	Procedure Per MIL-DTL-55116	Test Description	Procedure Per MIL-DTL-55116 Or Other Standard
Dielectric withstanding voltage	4.7.1	Pull test	4.8.7
Insulation resistance	4.7.2	Bounce	4.9.1
Contact resistance	4.7.3	Vibration	4.9.2 and MIL-STD-202G, method 201A
Contact depression	4.8.1	Drop	4.9.3
Air pressure	4.8.2	Temperature cycling	MIL-STD-202, method 107, test condition A
Mating durability	4.8.3	Salt spray	MIL-STD-202, method 101E, test condition B
Contact retention	4.8.4	Humidity	4.9.6 and EIA-364-31, method IV (step 7a not required)
Compression	4.8.6	Water immersion	4.9.7

Series 151 Standard MIL-DTL-55116 Type Audio Connectors - Product Selection Guide

	<b>151-001 Standard MIL-DTL-55116 type audio plug, field-servicable with wire strain relief and rigid contacts</b>
	<b>151-002 Standard MIL-DTL-55116 type audio plug with overmold adapter and rigid contacts</b>
	<b>151-003 Standard MIL-DTL-55116 type radio-mount Jam Nut receptacle with non-rigid spring contacts</b>
	<b>151-004 Standard MIL-DTL-55116 type in-line receptacle with wire strain relief and non-rigid spring contacts</b>
	<b>667-374 Protective Cover for 151 Series Plugs</b>
	<b>667-355 Protective Cover for 151 Series Receptacles</b>

SERIES 15  
CB Series Pogo Pin  
Audio Connectors



Series CB  
Cable Plug



Series CB  
Jam Nut Receptacle

- Qualified to VG95351 (seven pole) and VG96934 (ten pole)
- Ultraminiature version of U.S. standard 55116 audio frequency connectors
- Robust environmental, mechanical and EMI performance
- High durability—5000 mating cycles

The compact audio frequency bayonet connector with spring-loaded contacts—VG qualified!

CB Series Specifications	
Current rating	2.5 Amps per contact maximum
Voltage rating (DWV)	500 VAC
Insulation resistance	5000 MΩ
Durability	5000 cycles of mating, minimum
Contact resistance	5 mΩ
Water ingress protection	IP68
Water immersion	2 meters, 48 hours
Air pressure	0.4 bar
Operating temperature	-55° C to +85° C
Shielding effectiveness	50 dB attenuation up to 100 MHz
Corrosion resistance (salt spray)	48 hours
Maximum wire size	1mm maximum diameter



CB 10 Pin (left) Compared to MIL-DTL-55116 6 Pin Connector



Turnkey  
Cordsets

Self-Cleaning “Wiping” Contacts

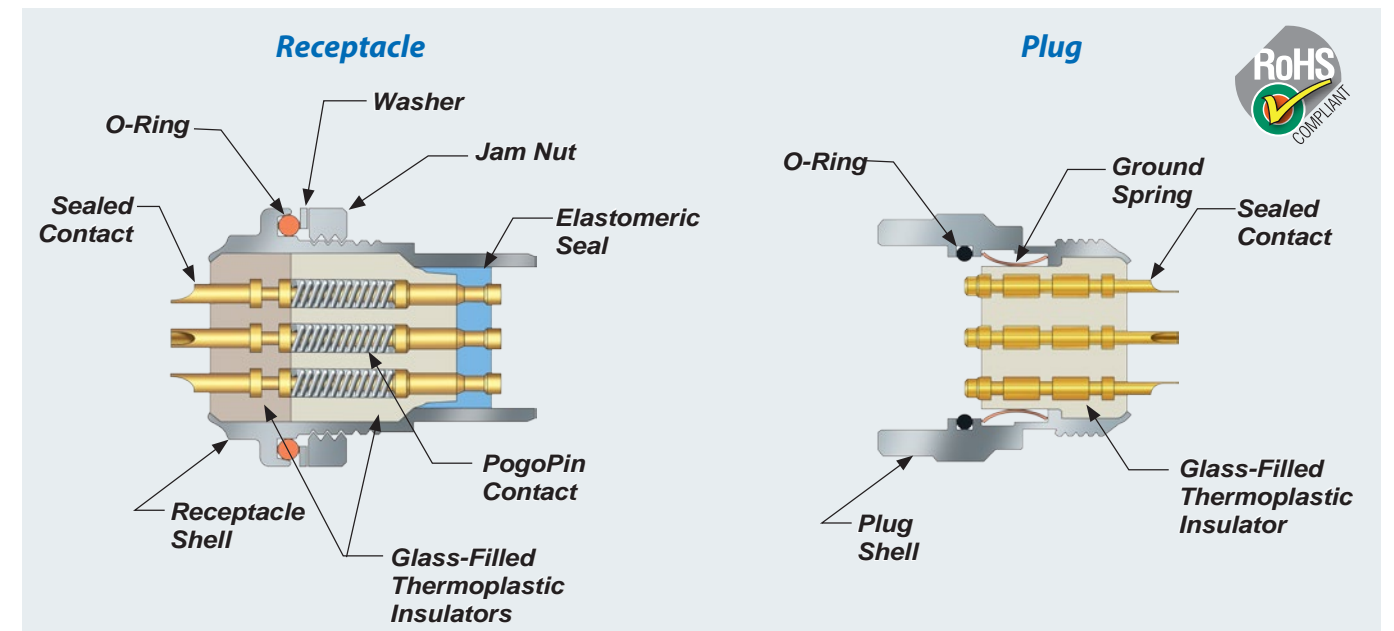
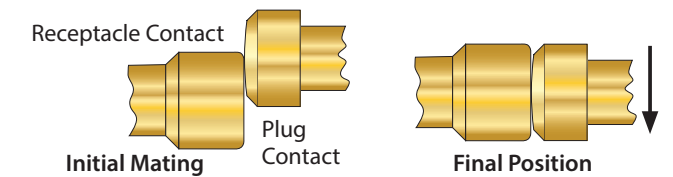



# Mil-Aero Circular Connectors

Environmental, hermetic, and filter class

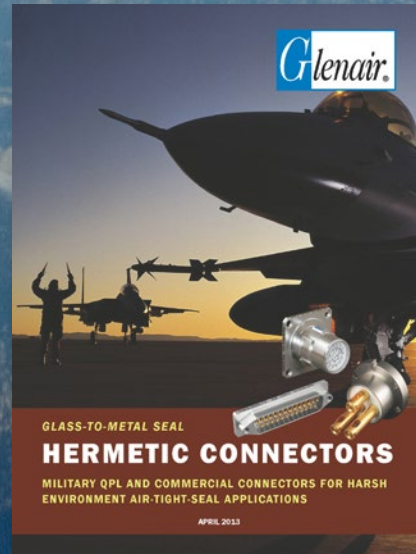

SuperNine® High-Performance MIL-DTL-38999 Series III Type Crimp, PC Tail, High-Speed and Hermetic Connectors

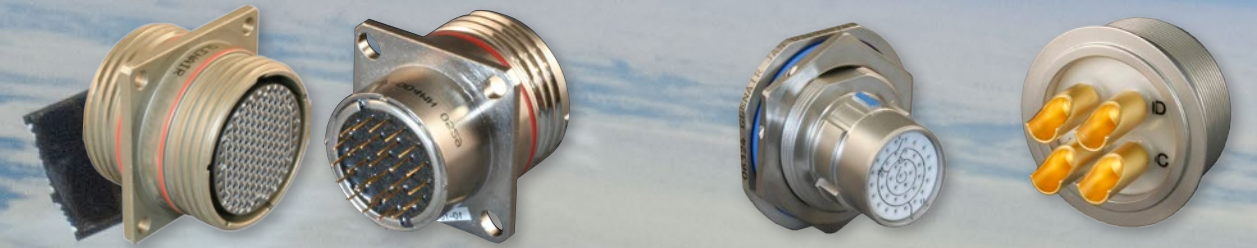

MIL-DTL-38999 Type Specials

Glass-Sealed Hermetic Connectors



EMI/EMP Filter Connectors

USB and RJ45 SuperSeal™ Connectors



Sav-Con® Connector Savers and Adapters

MIL-DTL-28840 Connectors

From satellites to ruggedized shipboard and aerospace applications, Glenair supplies virtually every power, signal, or high-speed cylindrical connector configuration currently in active use. From our QPL'd MIL-DTL-38999 hermetic connectors to our revolutionary SuperNine® family of high-performance D38999 Series III type connectors, Glenair is at the forefront in the manufacture and supply of mission critical mil/aero circulars.



For more information contact Glenair at 818-247-6000 or visit our website at [www.glenair.com](http://www.glenair.com) U.S. CAGE code 06324





BETTER THAN QPL

## SuperNine®: Glenair advanced-performance MIL-DTL-38999 Series III type connectors

SuperNine® is the industry's most complete and advanced D38999 Series III type connector family. From standard environmental-class connectors with improved durability and ease-of-use, to EMI/EMP filter connectors with innovative flange and PC tail termination configurations, SuperNine® offers military, commercial aerospace and other customers that have standardized on Series III technology the opportunity to improve interconnect system performance and resolve a wide range of persistent electrical, environmental, and mechanical performance problems—all with catalog connector solutions backed by Glenair's high-availability business model.

SuperNine® offers improved durability, sealing, cost-of-ownership, ease of shield termination, a broader range of PC tail configurations, environmental and hermetic bulkhead feed-throughs, connector savers, off-the-shelf EMI/EMP filter connectors and more—all supported with Glenair's well-established reputation for service, support, and fast turnaround.

### THE SUPERNINE® TECHNOLOGY PROMISE

- Across-the-board improvements in mating-cycle and contact durability
- Advanced ease-of-use features such as integrated shield-termination band porches and threaded PC-Tail standoffs
- High-performance improvements in every connector class—from filters to fiber optics

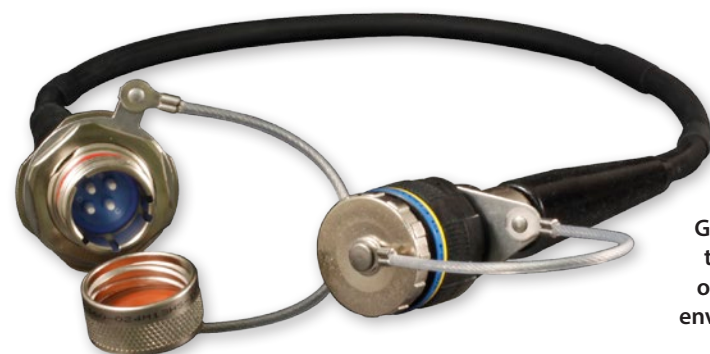

Glenair SuperNine® connectors in action: in this example, a pair of our advanced fiber optic interconnects cabled-up in a turnkey, environmentally sealed point-to-point jumper

BETTER THAN QPL  
SuperNine®

## Advanced performance MIL-DTL-38999 Series III Type Connectors

### SuperNine™ Environmental I/O and Cable Connectors



- Plug connectors with integrated ground springs and banding porch
- Complete range of crimp connectors with high-durability contacts
- Five different designs of printed circuit board connectors and standoffs
- Standard MIL-STD-1560 as well as high-density insert arrangements
- High-durability/advanced vibration and shock ratcheted coupling

### SuperNine™ High-Speed Connectors

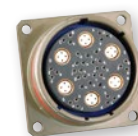

- Full range of hybrid insert arrangements incorporating size #22 signal contacts, plus size #12 and #8 keyed shielded contacts
- El Ochito®: One full 1G/10G Ethernet channel per standard size #8 cavity
- Supported applications: 10/100/1G/10G BASE-T Ethernet, analog/digital video, 1553 databus and general RF or differential data transmission
- Turnkey Quadrax and El Ochito® solutions—from crimp and PCB contacts to connectors

### SuperNine™ High-Pressure Hermetic Connectors



- Glass-to-metal seal pin/socket hermetics with sealing up to  $1 \times 10^{-10}$  cc/sec
- DSCC qualified and derivative solutions with advanced mounting features
- Pressure resistance to 32,000+ psi
- Stainless steel, titanium, Kovar® and Inconel® shell material options
- Bulkhead feed-through and hull penetrator versions

### SuperNine™ Ruggedized RJ45 and USB Connectors



- Insert-to-shell grounding for superior EMC continuity and shielding
- Superior environmental sealing, IP67 unmated compared to COTS solutions
- Advanced vibration and mechanical shock tolerance
- Full range of offerings for Cat6a Ethernet: Jacks, Plugs, PC tail and crimp
- High-temperature rated  $-40^{\circ}$  to  $+125^{\circ}$ C

### SuperNine™ EMI/EMP Filter Connectors



- Planar, multilayer ceramic capacitive filters with and without TVS diodes
- C, L-C, C-L, and Pi filter electrical configurations
- Special high operating temperature solutions
- Industry's broadest range of pF capacitance: from 10 to 1,000,000 pF
- Fast and reliable in-house manufacturing of all filter elements and processes

### SuperNine™ Fiber Optic Connectors



- Ultralightweight composite thermoplastic connector solution
- Qualified size #16 MIL-PRF-29504 pin-socket precision ceramic termini
- Ultra tight tolerance shell and cavity dimensions for precise axial alignment
- Ultra low insertion loss values for both singlemode and multimode
- Insert arrangements from 2 to 37 ways





MILITARY/AEROSPACE

# Environmental Connector Specials

Problem-solving mil-aero cylindrical connectors from the most accommodating engineering and manufacturing team in the interconnect industry—we say yes to specials!

## ENGINEERED SOLUTIONS AND EXOTIC DERIVATIVES

- High-density, push-pull, lanyard release, high temperature, ground plane, compliant pin, zero extraction force, thru-bulkhead, space-grade, gender changers, modified flange, or any other modification needed to solve a complex interconnect challenge
- Liberal policies on NRE costs, minimum order quantities and delivery schedules



Space-grade zero extraction force connector for satellite payload deployment



High-density contact arrangement with size #23 contacts



Unique coupling nut castellations and coverings



Special-purpose connector go-betweens and buffers

## MIL-DTL-38999 DERIVATIVES AND OTHER Environmental Connector Specials



### INNOVATIVE TERMINATION TECHNOLOGIES

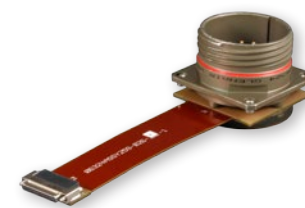

Flex and Rigid Flex



Compliant (Press-Fit)



Insertable Solder Cups

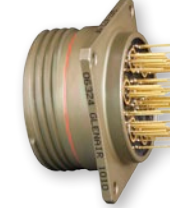

Variable-Length PC Tails



Ground Plane Inserts

### INNOVATIVE SHELL PACKAGE MODIFICATIONS



Mounting Flange Modifications



Bulkhead Penetrators



Integrated/Housed Electronics



Integrated Band/Boot Porch

### NON-STANDARD CONTACT LAYOUTS



Hybrid Power Contact Arrangement



Sealed Coax Insert Arrangement



Hybrid Shielded Contact / Signal Contact Insert Arrangement



Ground Plane Metallic Insert for Shielded Contacts

### INNOVATIVE MATING TECHNOLOGIES



Center Jackpost and Guide Pin Integration

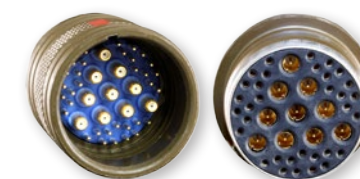

QDC Quick-Disconnect Push-Pull Mating



Quick-Disconnect Lanyard-Release Assemblies





HIGH-RELIABILITY  
**Glass-sealed  
 Hermetic  
 Connectors**

Resolve gas, moisture and particle ingress problems with advanced-performance glass-sealed hermetic connectors



**VITREOUS GLASS TECHNOLOGY ADVANTAGES**

- Superior pressure resistance to 32,000+ PSI
- Higher resistance to extreme operating temperatures to 260°+ C
- Superior mechanical strength
- No material breakdown or aging over time
- Helium leak rate <math>1 \times 10^{-7}</math> cc/sec to <math>1 \times 10^{-10}</math>

**CIRCULAR GLASS-SEALED HERMETIC CONNECTORS AVAILABLE WITH ACCELERATED LEAD TIMES**



MIL-DTL-26482



MIL-DTL-83723



MIL-DTL-38999 (QPL)



MIL-DTL-5015



Series 80 Mighty Mouse

MIL-DTL-38999 AND OTHER  
**Glass-Sealed  
 Hermetic Connectors**



**GEOPHYSICAL AND OFFSHORE CONFIGURATIONS**



GeoMarine® double-start hermetic connector



Hermetic power connector



Single-way tool joint hermetic connector



Hermetic probe connector



Hermetic bulkhead penetrator

**HIGH-SPEED/SHIELDED DESIGNS**



Triax hermetic



Hybrid coax/signal hermetic



Quadrax hermetic



MT ribbon fiber optic hermetic

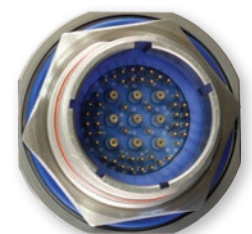

Hybrid coax/signal hermetic

**RECTANGULAR PACKAGES**



MIL-DTL-24308 QPL hermetic



Series 79 Micro-Crimp hermetic



MIL-DTL-83513 type micro-D hermetic



Sealed panel-mount micro-D hermetic

**MIL-DTL-38999 QPL PIN AND SOCKET HERMETICS**



Series I Scoop-proof 3 Point Bayonet Coupling



Series II Low-profile 3 Point Bayonet Coupling

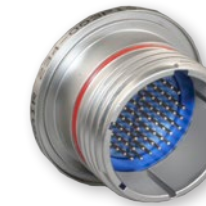

Series III Scoop-proof Triple Start, Self-Locking



Series IV Scoop-proof Breech Lock





SERIES 240

# EMI/EMP Filter Connectors

Glenair manufactures a full range of filter connectors for use in EMC/EMP management of electronic systems and interconnect cabling. All connectors are designed in accordance with applicable connector specifications, and are designed to mate with plugs with the same insert configuration and opposite contact gender. Planar filter arrays and TVS diodes may be integrated into both standard catalog as well as build-to-order configurations. Glenair's state-of-the-art diode burn-in process tests leaded and surface mount diodes with leakage current monitored throughout the entire test procedure ensuring field reliability.



- Planar, multilayer ceramic capacitive filters, with and without transient voltage suppression diodes
- C and Pi electrical configurations
- PC tail, crimp or solder cup termination
- 35 – 240,000 pF capacitance
- Fast and reliable diode burn-in and test services
- Turnkey in-house manufacturing of all filter connector elements and processes

Table I: Capacitor Array Code / Capacitance Range

Class	Pi - Circuit (pF)	C - Circuit (pF)
X	160,000 - 240,000	80,000 - 120,000
Y	80,000 - 120,000	40,000 - 60,000
Z	60,000 - 90,000	30,000 - 45,000
A	38,000 - 56,000	19,000 - 28,000
B	32,000 - 45,000	16,000 - 22,500
C	18,000 - 33,000	9,000 - 16,500
D	8,000 - 12,000	4,000 - 6,000
E	3,300 - 5,000	1,650 - 2,500
F	800 - 1,300	400 - 650
G	400 - 600	200 - 300
J	70-120	35-60



ARINC 600 size 2 filter connector. Glenair also manufactures narrow-profile size 1 and double-wide size 3. All configurations are environmentally sealed for rugged airframe applications.

## SERIES 240 EMI/EMP Filter connectors Fast, reliable in-house manufacturing

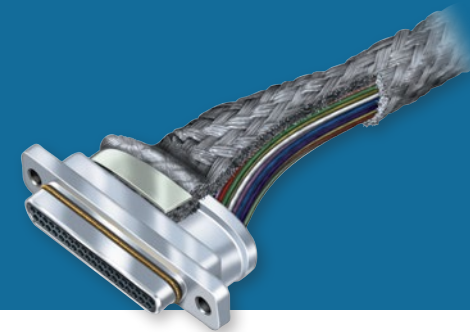

### UNIQUE AND SPECIAL PURPOSE EMI/EMP FILTER CONNECTORS



Extended-shell PC-tail cylindrical with threaded standoff    Special-purpose filter connector cable adapter    Series 80 Mighty Mouse PC-tail filter receptacle    MIL-STD-1760 filtered umbilical connector    Filter plug with crimp contacts

### RECTANGULAR PACKAGING

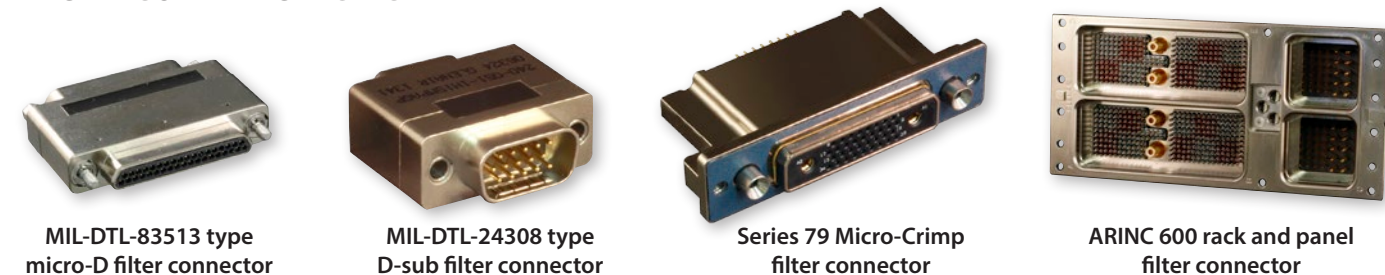

MIL-DTL-83513 type micro-D filter connector    MIL-DTL-24308 type D-sub filter connector    Series 79 Micro-Crimp filter connector    ARINC 600 rack and panel filter connector

### EMP TRANSIENT VOLTAGE SUPPRESSION DIODE-EQUIPPED

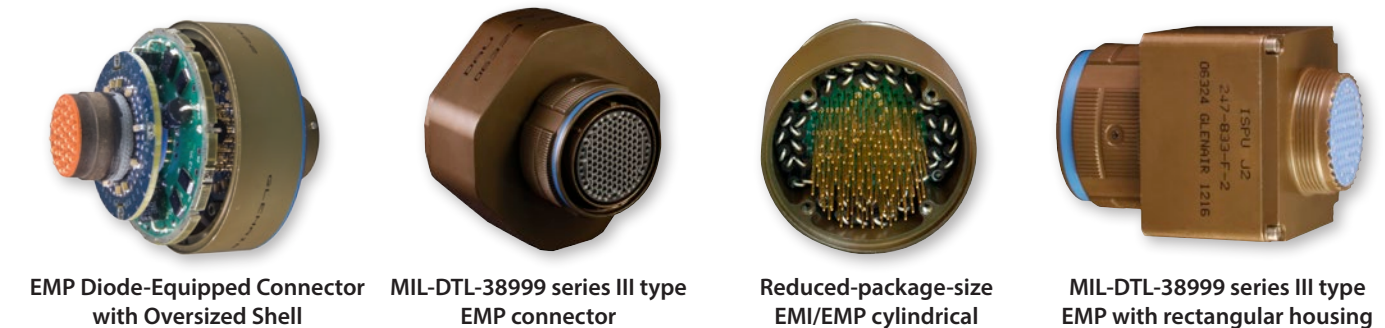

EMP Diode-Equipped Connector with Oversized Shell    MIL-DTL-38999 series III type EMP connector    Reduced-package-size EMI/EMP cylindrical    MIL-DTL-38999 series III type EMP with rectangular housing

### THE INDUSTRY'S MOST COMPREHENSIVE AND COMPLIANT FILTER SERVICE

Requirement Compliance:
MIL-STD-449D: RF Spectrum
MIL-STD-461E: EMI Susceptibility
MIL-STD-1310G: Shipboard EMC
MIL-STD-1512: Electroexplosive Subsystems
MIL-STD-1541A: EMC for Space Systems
MIL-STD-1795A: Aerospace Lightning Protection
MIL-STD-1857: Grounding, Bonding and Shielding
MIL-STD-1542B: EMC and Grounding for Space Systems
EN 61000-4-2, 3, 4, 5, 6, 8: EM, RF and Power
RTCA/DO-160 Sec 22: Pin/Cable Level and Waveform

Connector Series:	
38999	83513
Series I, II, III, IV	5015
26482	Sr. 80 Mighty Mouse
83723	Sr. 79 Micro-Crimp
28840	Sr. ITS Reverse-Bayonet
24308	Sr. 28 HiPer-D
ARINC 600	Sr. 970 PowerTrip

Line Types:	
CAN BUS	TTL
ARINC 429	Analog Sensors
RS 232	Thermocouple Wires
RS 422	USB
RS 485	Ethernet

Filter Types  
**C** Single capacitor with low self inductance  
**Pi** Dual capacitors with a single inductive element positioned between.

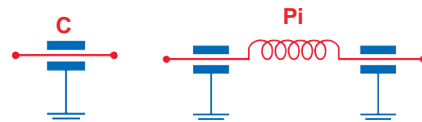





SUPERSEAL



## Ruggedized RJ45 and USB Connectors for Aerospace, Defense and Other Applications

Triple-start mating MIL-DTL-38999 type connectors with IP68 sealing (mated condition), robust insert-to-shell grounding, and a complete range of wire, cable, and circuit board terminations



MIL-DTL-38999 Series III with sealed RJ45

MIL-DTL-38999 Series III with USB jack and jumper

High-capacity, high-speed USB data stick

- Superior sealing—IP67 unmated—for complete system protection against water, sand and dust
- Highly durable RJ45 design, including enhanced operating temperature, increased life-cycle, and rugged vibration and shock performance
- Shielded/grounded coupler designs in both receptacle and plug connectors
- Crimp, solder-cup, PC tail, and Quadrax contact/wire termination options
- RJ45 plug and/or jack interface options available in Cat 5e or Cat 6a
- Intermateable with other MIL-DTL-38999 type RJ45 field-duty connectors

## SUPERSEAL MIL-DTL-38999 SERIES III TYPE RJ45 and USB Aerospace/Defense Connectors



### Product Selection Guide



233-300

SuperSeal™ MIL-DTL-38999 Series III Type Connector/Adapter with RJ45 Jack/Jack or Plug/Jack Couplers



233-301

SuperSeal™ MIL-DTL-38999 Series III Type Connectors with RJ45 Jack or Plug to Rear Crimp Contact Termination



233-302

SuperSeal™ MIL-DTL-38999 Series III Type Connectors with RJ45 Jack to PC Tail Termination

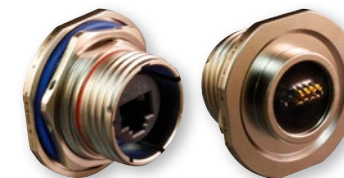

233-303

SuperSeal™ MIL-DTL-38999 Series III Type Connectors with RJ45 Jack to Rear Solder Cup Termination



233-304

SuperSeal™ MIL-DTL-38999 Series III Type Connectors with Pin or Socket Contacts to RJ45 Jack or Plug Interface



233-305

SuperSeal™ MIL-DTL-38999 Series III Type Connectors with Pin or Socket Quadrax to RJ45 Jack or Plug



233-330

SuperSeal™ MIL-DTL-38999 Series III Type Feedthrough Receptacle with RJ45 Jack to Jack Coupler





SERIES 234-105

# MIL-DTL-38999 Series IV\*

\*Mil-Spec qualification pending

## Time-tested, industry standard breach-lock connector

From vertical launch fire-control, tracking, and multi-target missile systems to rugged industrial applications such as mining/gas-pressure blasting, the Glenair MIL-DTL-38999 Series IV type connector is the ultimate solution for positive and reliable breach-locking connector performance. Built IAW MIL-DTL-38999 Series IV, Glenair series 234-105 plug and receptacle connectors are available in shell sizes 11–25, with all MIL-STD 1560 insert arrangements as well as high-density and hybrid shielded contact arrangements. The heart of the 234-105 connector is its revolutionary coupling nut/locking technology which provides familiar breach-lock mating augmented with both primary and secondary locking mechanisms. Environmentally sealed, EMI grounded, and outfitted with pin-to-pin mating protection to prevent circuit shorts and mechanical damage, the Glenair 234-105 delivers unsurpassed reliability and anti-demating performance.

- IAW MIL-DTL-38999 Series IV
- Optimized for SWAMP area applications
- Quick-disconnect 90° breach coupling mechanism
- Visual, audible and tactile full-mate indicators
- Integrated EMI grounding fingers
- -65°C to 200°C operating temperature range

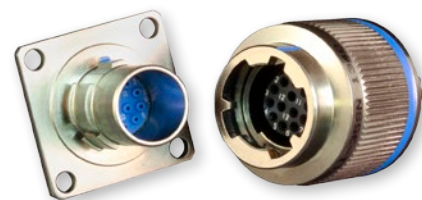

Series IV solutions are available in environmental, filter, and hermetic class configurations in shell sizes from 11–25 supporting the full range of MIL-STD-1560 insert arrangements



Glenair's complete Series IV solution includes protective covers and dummy stowage receptacles—available in all sizes, materials, and plating configurations.

## SERIES 234-105 MIL-DTL-38999 Series IV

Industry standard breach-lock connector  
Super fast turnaround on quotes and orders



### SERIES 234-105 PLUG AND RECEPTACLE, LOCKING, HIGH-VIBRATION



How To Order	
Sample Part Number	234-105 -44 NF 11 -35 P N
D38999 Series IV Type Connectors	234-105 = Environmental Class*
Connector Style	See Table I
Material/Finish	See Table II
Shell Size	11, 13, 15, 17, 19, 21, 23, 25
Contact Arrangement	Per MIL-DTL-1560
Contact Designator	P = Pin      A = Pin Gender, Less Contacts S = Socket    B = Socket Gender, Less Contacts
Polarization	N (Normal), A, B, C, D, K, L, M, R, & U

#### NOTES

1. Materials and finish  
Insulator: High grade rigid dielectric  
O-ring: Silicone  
Contacts: IAW AS39029  
Seals: Fluorosilicone blend
2. Blue color band indicates rear release contact retention system
3. Connector supplied with contacts (including spares), insertion/removal tools and sealing plugs IAW MIL-DTL-38999
4. Glenair 234-105 connectors are designed to mate with any QPL manufacturer's MIL-DTL-38999 Series IV connectors with the same insert arrangement and polarization. Mil-spec qualification pending.

Table I: Connector Style	
40	Square-flange wall mount receptacle
42	Box-mount square flange receptacle
44	Jam nut receptacle
46	Plug with EMI grounding spring
47	Plug without EMI grounding spring
49	In-line cable receptacle

\*Glenair also supplies a full line of qualified MIL-DTL-38999 Series IV pin and socket contact hermetic receptacles—most popular part numbers in stock and ready for immediate shipment

Table II: Material / Finish		
Symbol	Material	Finish
ME	Aluminum	Electroless Nickel
NF		Cad O.D. over Electroless Nickel
G2		Anodize, Hardcoat
ZR		Zinc Nickel, Black
MT		Nickel-PTFE
Z1*	Stainless Steel	Passivate
ZL*		Electro-Deposited Nickel

\*Available in receptacle only. Not firewall rated.



A complete range of application tooling is available, including adjustable crimp tools, contact insertion and removal tools, Band-Master™ EMI shield termination system tools and others—all available for immediate, same-day shipment



For more information contact Glenair at 818-247-6000 or visit our website at [www.glenair.com](http://www.glenair.com) U.S. CAGE code 06324





# HIGH-PERFORMANCE CONNECTOR GO-BETWEENS

## Sav-Con® Connector Savers and Bulkhead Feed-Thrus

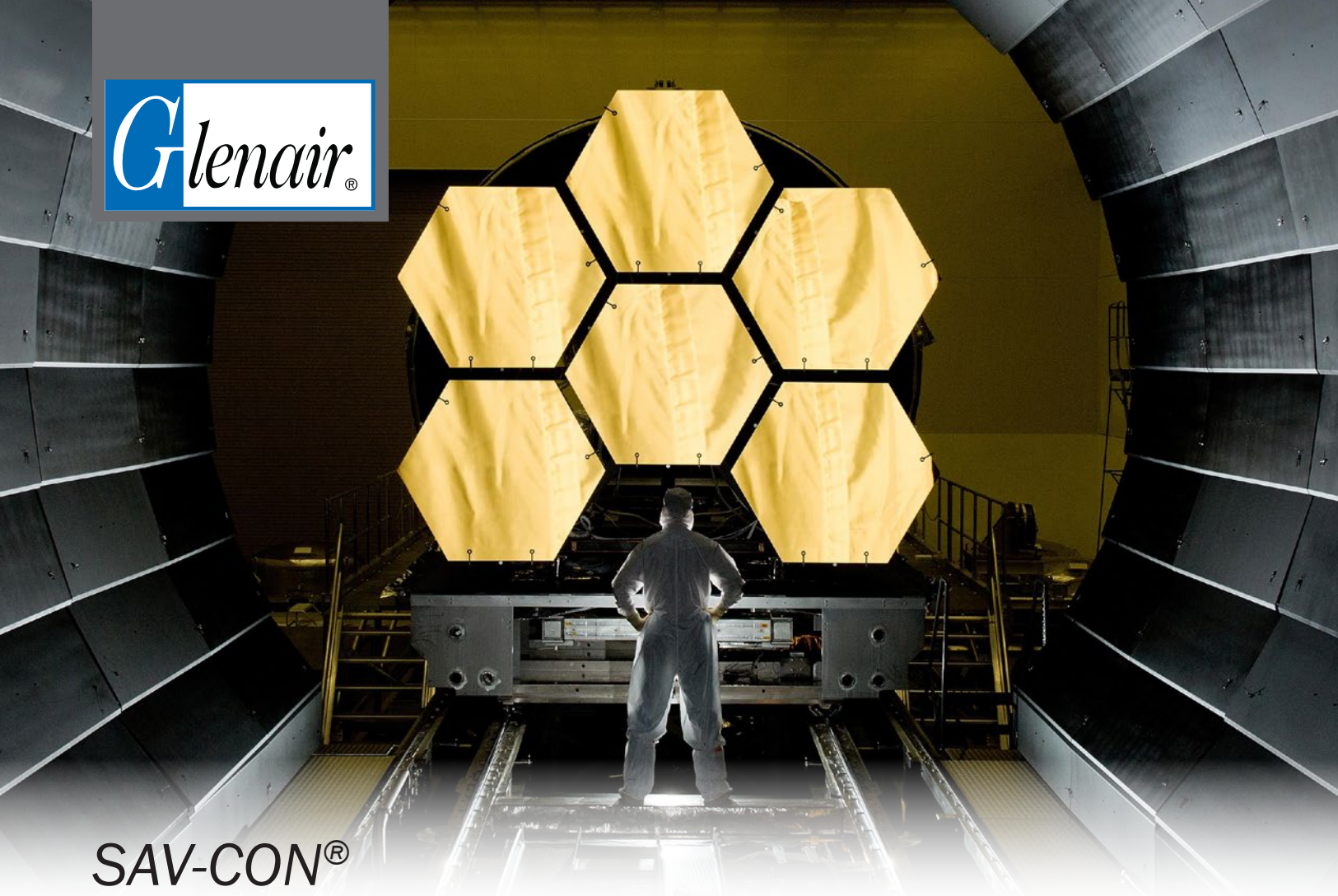

SAV-CON®

# Connector Savers and Bulkhead Feed-Thrus

The smart solution for preventing contact damage and extending the service life of cable assemblies and box and panel-mount receptacles

Series changers and gender changers available in both Sav-Con® and bulkhead feed-thru configurations

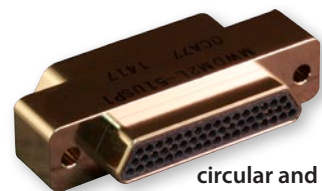

circular and rectangular configurations available

Sav-Con® Lock Ring prevents accidental disengagement of bayonet coupled connectors

Locking a Sav-Con® Connector Saver to a receptacle can prevent accidental or unauthorized unmating. This can ensure that the equipment receptacle remains in its unused condition prior to delivery.

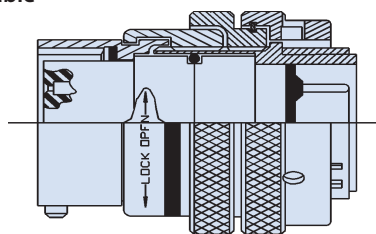

- Sav-Con®s for every Military Standard connector
- Bulkhead feed-thrus for environmental, filter and hermetic applications
- Pin/pin, pin/socket, and socket/socket versions
- Traditional plug-receptacle savers, as well as in-line versions and gender changers
- Available EMI/EMP filter savers and adapters
- Optional locking mechanism

Each Glenair Sav-Con® Connector Saver meets the military specification performance requirements of its mating connector. Glenair manufactures and supplies a Sav-Con® connector saver for every military standard connector currently in use including:

- MIL-DTL-26482 Series I and II
- MIL-DTL-28840
- MIL-DTL-38999 Series I, II and III
- MIL-DTL-83723
- LN 29729 (SJT)
- PATT 105 and PATT 602
- MIL-DTL-5015
- Series 801 and 805 Mighty Mouse
- M24308 D-Subminiature
- MIL-DTL-83513 Micro-D Subminiature
- Series 28 HiPer-D M24308 intermateable
- Series 79 Micro-Crimp

Comprehensive materials, plating, and polarization options available

### TRADITIONAL PLUG-RECEPTACLE SAV-CON® CONNECTOR SAVERS

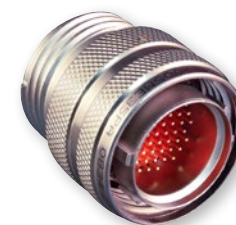

MIL-DTL-38999 series III type

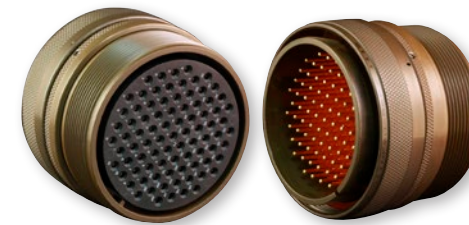

MIL-DTL-5015 threaded and/or reverse-bayonet



MIL-DTL-38999 series II bayonet-coupling saver



Series 80 Mighty Mouse Sav-Con®

### BULKHEAD FEED-THRU



MIL-DTL-38999 series III type jam nut and square-flange bulkhead feed-thru



MIL-DTL-5015 bulkhead feed-thru



Special shielded contact bulkhead feed-thru

### SPECIAL-PURPOSE ADAPTERS AND SAVERS



EMI/RFI filter Sav-Con® adapter

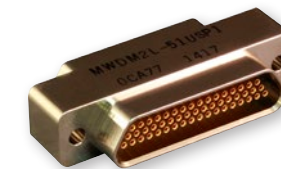

MIL-DTL-83513 type micro-D filter connector



Special in-line receptacle-to-receptacle feed-thru



Power distribution connector saver





MIL-DTL-28840 qualified connectors in-stock and ready for immediate, same-day shipment

- High density, scoop proof contact arrangements
- Flange mount, box mount, jam-nut and in-line receptacles
- Straight, 45° and 90° strain reliefs and backshell assemblies
- Sav-Con® connector savers
- MIL-DTL-28840 qualified
- Additional glenair commercial part numbers with features not available in the mil-spec

Qualified military standard electrical connectors and accessories for shipboard—and all rugged environmental applications



Splined MIL-DTL-28840 connector-to-backshell interface is ideally suited for heavy backshells and cables

Performance Specifications	
Current Rating (Maximum)	Size #20 Contact with 20AWG wire=7.5Amps, with 22AWG wire=5.0Amps
Test Voltage (DWV)	1000 VAC RMS at sea level. Test per EIA-364-20
Insulation Resistance	5000 megohms minimum (at ambient temperature) per EIA-364-21
Contact Resistance	Per SAE-AS39029
Operating Temperature	-55° C to +200° C
Immersion	per test method EIA-364-09
Shock	in accordance with MIL-S-901 grade A
Vibration	per EIA-364-28 test procedure
Magnetic Permeability	2.0 μ (Aluminum), 5.0 μ (Stainless Steel) maximum; ASTM-A342/A342M

AVAILABLE CONTACT ARRANGEMENTS

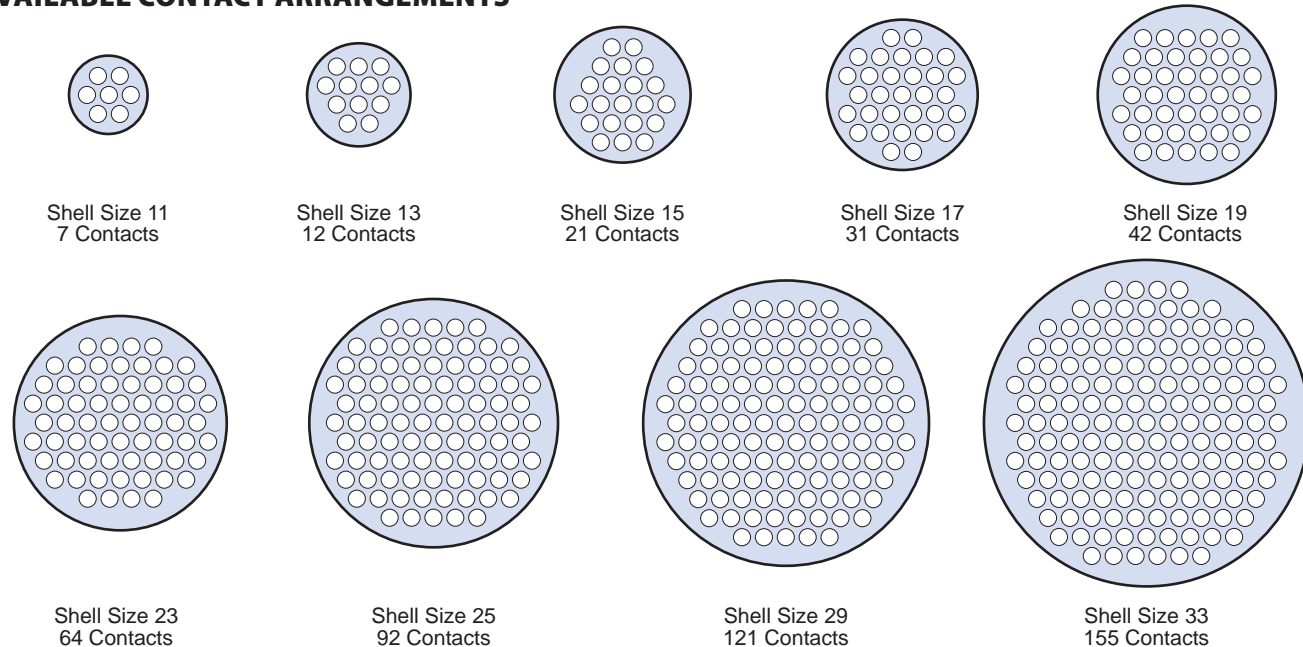

STANDARD PIN CRIMP CONTACT FOR MIL-DTL-28840 CONNECTORS



Mating End Size	Wire Accomodation	Military Part Number	Glenair Part Number
20	28-32 AWG	M39029/83-451	850-004-20-451
20	22-26 AWG	M39029/83-450	850-004-20-450
20	20-24 AWG	M39029/83-508	850-004-20-508

STANDARD SOCKET CRIMP CONTACT FOR MIL-DTL-28840 CONNECTORS



Mating End Size	Wire Accomodation	Military Part Number	Glenair Part Number
20	28-32 AWG	M39029/84-453	850-005-20-453
20	22-26 AWG	M39029/84-452	850-005-20-452
20	20-24 AWG	M39029/84-509	850-005-20-509

**Crimping Tools**

M22520/34-01 Basic Crimp Tool  
M22520/34-02 Positioner  
M22520/35 Gage

**Insertion & Removal Tools**

M81969/33-01 Straight Insertion Tool  
M81969/33-02 Offset Insertion Tool  
M81969/34-01 Removal Tool

**Pin Contact**

M39029/83 Standard Duty Electrical Pin Contact

**Socket Contact**

M39029/84 Standard Duty Electrical Socket Contact

**Environmental Backshells**

M28840/6 B Straight  
M28840/9 B 45°  
M28840/8 B 90°

**EMI/RFI Environmental Backshells**

M28840/6 A Straight  
M28840/8 A 90°  
M28840/9 A 45°

**Connector Sockets**

600G005

**Non-Self-Locking**

M28840/23

**Strain Reliefs**

M28840/1 Straight  
M28840/3 45°  
M28840/2 90°

**Dummy Storage Receptacles**

M28840/7

**Protective Plug Covers**

M28840/15

**Protective Receptacle Covers**

M28840/13

**Jam Nuts**

MS3186

**Mounting Flanges and Gaskets**

M28840/24 Gasket

**MIL-PRF-24758A Conduit Fittings**

M24758-14 Straight (M24758/14 Straight.)  
M28840/5 Straight • M28840/25 90° • M28840/27 45° • M28840/30 Coupling



VG QUALIFIED AND COMMERCIAL

# Industrial-Strength Power and Signal Connectors

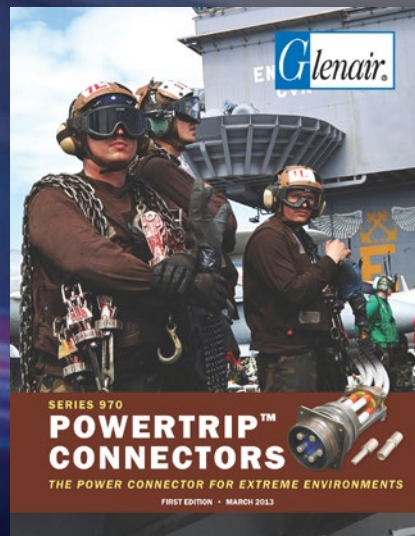

Industrial-Strength Power and Signal Connectors



Series ITS and Derivative Industrial/Rail Power and Signal Connectors



Series IRT/ITS/UJ High-Current/High-Voltage Power Connectors for Rail and Industrial Applications



PowerTrip™ Extreme Environment Power Connectors

Ruggedized High-Speed Ethernet Connectors



Series 22 Geo-Marine® High-Pressure Harsh-Environment Connectors and Cordsets

Glenair offers a “no gap” family of ruggedized power and signal interconnect solutions for industrial, rail, geophysical and power industry applications. No other interconnect manufacturer in the world supplies such a broad range of connectors, backshells, wire protection conduit, shrink boots, tools and more to meet harsh-environment industrial requirements. All our solutions are backed with our high availability customer service model, which includes in-stock inventory for thousands of critical part numbers, no dollar or quantity minimum orders, free samples upon request, free engineering and application development and more. Contact the factory or our industrial/rail product team for application engineering assistance.



For more information contact Glenair at 818-247-6000 or visit our website at [www.glenair.com](http://www.glenair.com) U.S. CAGE code 06324





## SERIES ITS & DERIVATIVES

Circular industrial power and signal connectors for rugged applications—from mining equipment to military vehicles



- Dozens of proven connector technologies for harsh application environments
- Hundreds of power and signal contact arrangements (crimp and solder)
- Threaded, reverse bayonet, and innovative latch-and-lock coupling technologies
- Flame-resistant, caustic substance-free material choices for RoHS and other compliance standards

### Circular Reverse-Bayonet and Threaded Coupling Connectors

- Series ITS* - Reverse-Bayonet Power and Signal
- Series ITS-RG* - RadGrip™ Rubber Coupling Nut Circular
- Series FRITS* - Flame-Resistant Insert for Rail Applications
- Series IT* - Threaded Coupling Power and Signal
- Series ITH* - Rigid Insert / Mechanical Contact Retention
- Series ITK* - High-Temperature Ceramic
- Series ITZ* - Triple-Start Thread Power and Signal
- Series IFO* - Reverse-Bayonet Fiber Optic
- Series IGE* - High Current, Low Voltage Single Pole
- Series 901* - High Current Medium Voltage Circular
- Series 500* - Reverse-Bayonet Single-Pole High Voltage
- Series IPT* - Standard Bayonet Power and Signal
- Series IPT-SE* - Standard Bayonet Crimp Contact



Series IT, ITS and derivative connector families are available with three plug coupling nut designs: Standard, Arctic, and rubber-covered RadGrip™

### CIRCULAR INDUSTRIAL/RAIL POWER AND SIGNAL CONNECTORS: 5015 TYPE DERIVATIVES



Series ITS Reverse-Bayonet



Series ITH Rigid Insert



Series IT Threaded Coupling



Series ITZ Triple-Start Coupling



Series ITK High-Temperature Ceramic Insert



Seacrow Marine Bronze



Series 901 Multi-Pin High Voltage



Series 500 Single-Pole High Voltage



Series IGE Single-Pole High Power



Series ITS Bayonet with Wing Locks

### HIGH-SPEED / RUGGEDIZED CONNECTORS FOR INDUSTRIAL AND RAIL APPLICATIONS



SuperSeal™ with RJ45 Ethernet



Series CX High-Speed Coaxial



Octobyte™ Ethernet Contact



Series IFO High-Speed Fiber Optic

### SERIES ITS-RG RADGRIP™ REINFORCED RUBBER COUPLING NUT CONNECTORS



ITS-RG (Basic Black)



ITS-RG (Semper Tan)



ITS-RG (Fiber Optic Blue)



ITS-RG (Safety Red)





## SERIES IRT • ITS 500 • ITS 901 • UJ

### Rugged high current/high voltage power connectors for rail and industrial applications

Connection of power cables in rolling stock is a critical application. Beyond specific parameters like voltage, current, or watertight sealing, other application requirements must be considered: environment and operating conditions, robustness, handling, and other specifications.

The IRT connector series is one of the most popular connection systems used around the world, and is able to satisfy all of the common parameters from different railway authorities. Glenair is able to develop customized connectors for specific applications, certifying the products according to unique customer requirements.



Innovative tool-free locking and latching mechanisms

#### SERIES IRT RECTANGULAR MULTIPOLE HIGH VOLTAGE TRACTION MOTOR CONNECTORS



Plug Connector



Receptacle Connector

The Glenair IRT series is a rectangular power connector for harsh environmental conditions. Available with three, four and six contacts, typical for traction motor applications. Suitable for single cables AWG 4 – 373MCM (35 to 185 mmq). Working voltage up to 3000 Vcc.

Two mating systems offered:

- Screws, for light weight and reduced dimensions
- Lever system with secondary lock, easy to use in difficult positions.

The IRT Series is suitable for separated power cables, with or without shielding, ground body available with a copper plait.

Available with three different cable backend styles:

- Metallic gland
- Clamp with strain relief
- EMC shield and gland

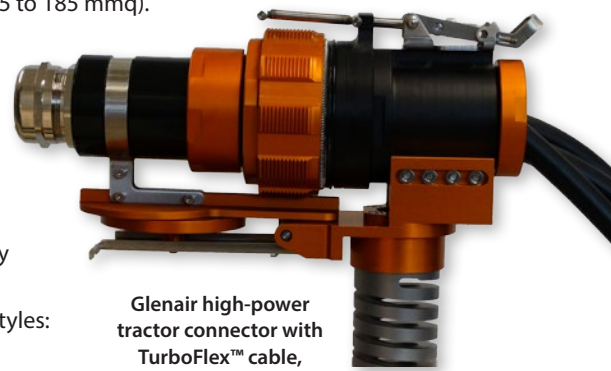

Glenair high-power tractor connector with TurboFlex™ cable, locking/lever coupling, and flexible standoff

SERIES IRT • ITS • UJ

## High Current/High Voltage Power Connectors

for rail and industrial applications



#### ITS 901 SERIES REVERSE BAYONET MULTI-POLE MEDIUM VOLTAGE JUMPER CONNECTORS



Plug Connector



Receptacle Connector

ITS 901 Series is the extension of the ITS Reverse Bayonet connector family, for power cables over AWG 1/0.

Suitable for harsh environmental conditions, 901 Series Connectors accept cable from AWG 4 to 262 MCM (35 - 120 mmq), for current up to 450 Amp.

Working voltage: 800 - 1000 Vac.

Available for single wires and multipole jacketed cables, with cable clamp or conduit.

Male contacts with Finger Test Protection, Load Side (Receptacle or Plug).

Long bayonet ramps, three polarization keys and rubber recovered coupling facilitate mating and unmating operations.

901 Series meet the most important rail requirements and specifications:

- Salt Spray Test Corrosion: 500 hours;
- 500 Mating Cycles;
- Shock and Vibrations for Under-Car and Car-To-Car Applications;
- IP67 Sealing (Coupled Connectors);
- Fire Resistant and RoHS Compliant Materials.

#### ITS 500 SERIES REVERSE BAYONET SINGLE-POLE HIGH VOLTAGE JUMPER CONNECTORS



Plug Connector



Receptacle Connector

ITS 500 Series derives from an important Military Specification for Power Connectors: VG96929. Suitable for harsh environmental conditions, ITS 500 accepts cable gauges AWG 3/0 to 444MCM (95-240 mmq), for current up to 750 Amp.

Special insulator drawing allows high working voltage, up to 3000 Vcc.

Suitable for jacketed cables, with or without conduit protection.

Receptacle with finger protection (Load side).

ITS 500 meets the most important rail requirements and specifications:

- 500 Mating Cycles;
- Salt Spray Test Corrosion: 500 hours;
- Shock and Vibrations for Under-Car and Car-To-Car Applications;
- IP67 Sealing (Coupled Connectors);
- Fire Resistant and RoHS Compliant Materials.

#### UJ SERIES POWER JOINT CONNECTOR SYSTEM



Offers the possibility to connect medium and high power cables without the need for bulky junction boxes. The UJ Power Joint System offers the same environmental protection with substantial size and weight savings.

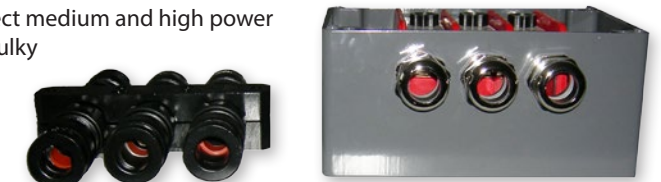

	UJ Series	Junction Box
Dimensions	Small	Regular / Big
Weight	Light	Heavy
Protective Varnish	No	Yes
Modularity	Yes	No
Environmental	Yes	Yes
Electrical Performance	Yes	Yes
Cost Reduction	Yes	No
Temperature Range	High	Standard





# SERIES 970 PowerTrip™

Reduced size and weight power connectors



Lightweight plug with ratcheting coupling nut and LouverBand contacts

Keyed receptacle with superior sealing and EMI shielding contacts



- **Fast, easy mating with triple-start ACME thread: 360° turn for full mating**
- **Reduced size and weight compared to 5015/VG95234 solutions**
- **LouverBand sockets for improved current ratings and longer life, up to 2000 mating cycles**
- **Splined backshell interface for improved backshell attachment and EMI shielding**
- **Ratcheting coupling nut for secure mating**
- **Operating temperature -65° C to +200° C**
- **Hermetic and filter options available**

The Series 970 PowerTrip™ offers improved performance compared to standard 5015 type power connectors: higher density and lighter weight packaging, rapid mating and demating triple-start threaded coupling, and extremely rugged splined and threaded backshell attachment interface

## SERIES 970 PowerTrip™

The power connector for extreme environments



### SERIES 970 POWERTRIP™ CONNECTOR STYLES

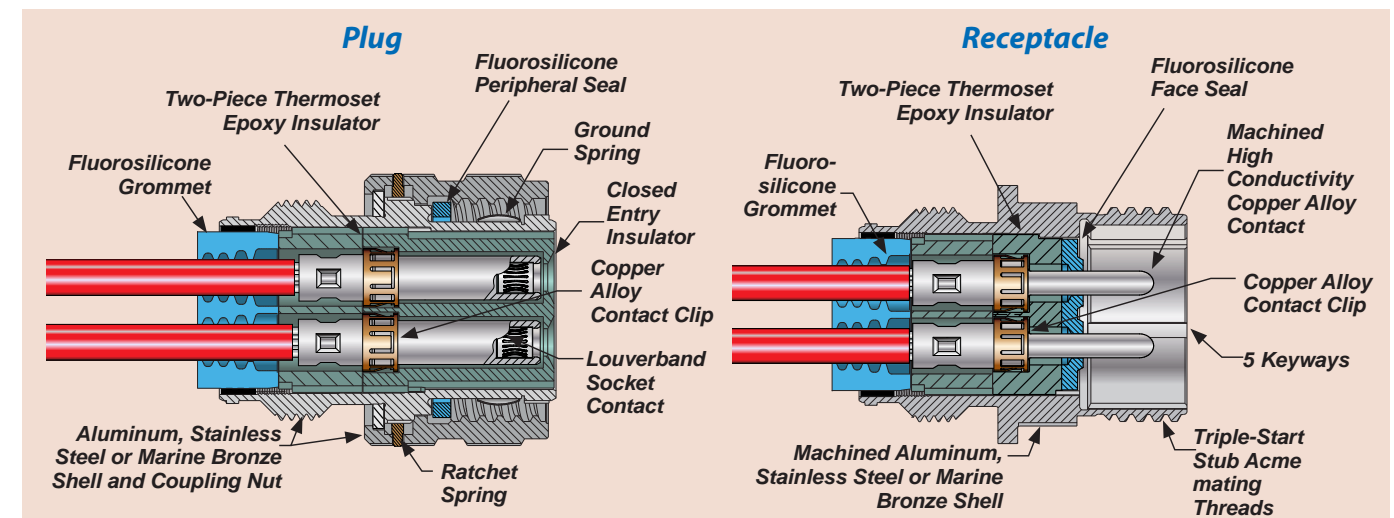
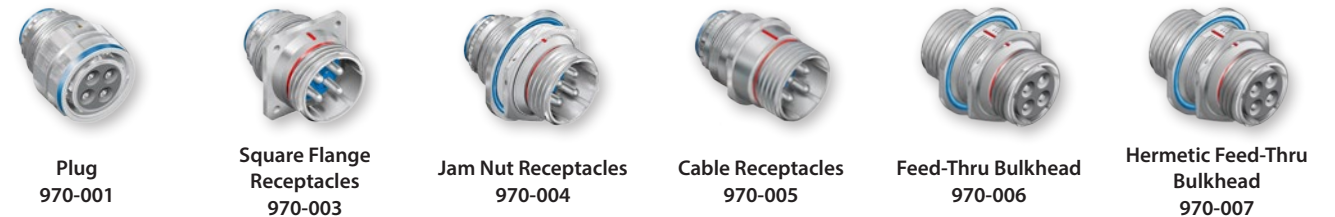

Series 970 PowerTrip™ Specifications	
Current Rating	Up to 225 A.
Dielectric Withstanding Voltage	2000 VAC
Insulation Resistance	5000 megohms minimum
Operating Temperature	-65° C. to +200° C.
Shock	300 g.
Vibration	37 g.
Shielding Effectiveness	65 dB minimum from 1GHz to 10GHz.
Durability	2000 mating cycles

### ABOUT THE POWERTRIP CONTACT SYSTEM

Series 970 contacts are precision-machined using high conductivity copper alloy. A stamped and formed spring ("LouverBand") is installed into the socket contact. The spring is made from 6 mil copper alloy. Testing has demonstrated that this contact system outperforms conventional aerospace-grade contact systems. The LouverBand spring provides many points of electrical contact with the mating pin, as opposed to a few "high spots" on a conventional four-finger contact as shown in the figure below. The size #8 Powertrip socket contact has a total of 18 louvers. The #4 has 27 louvers, and the #1/0 has 42 louvers. The LouverBand design offers lower voltage drop for reduced joule heating. In addition to its electrical advantages, the LouverBand also is mechanically superior to four-finger contacts. The LouverBand spring has consistent, stable normal force, even when subjected to thousands of mating cycles and temperature extremes.

### CONTACT RESISTANCE AFTER 1000 MATING CYCLES

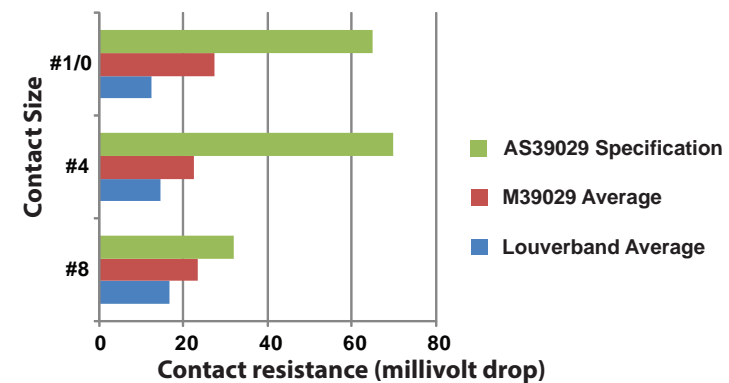

Conventional contact on the left, LouverBand contact on the right

LouverBand socket contact cutaway





## RJ45/USB SUPERSEAL™

# Ruggedized bayonet and reverse-bayonet RJ45 and USB connectors for industrial/rail applications

Glenair offers the world's most comprehensive line of ruggedized RJ45 Ethernet and USB connectors in 5015 and 26482 type connector packaging. The Series ITS reverse-bayonet and IPT bayonet RJ45/USB SuperSeal™ lines offer fast mating and demating, resistance to vibration and shock, as well as superior sealing for complete protection against water, sand and dust in harsh environment applications. High-performance RJ45 and USB inserts feature integrated shielding and grounding in both plug and receptacle connectors plus crimp, solder-cup, PC tail and Quadrax contact/wire termination options.



In addition to ITS series (5015 type) reverse-bayonet solutions, low-profile series IPT bayonet RJ45 SuperSeal™ connectors and integrated box assemblies are also available

- Proven reverse-bayonet mating for vibration and shock resistance
- Superior sealing—IP67 in unmated condition—compared to other available environmental circulars
- Rear-release crimp contact termination and USB/RJ45 jumper accommodation
- Superior grounding for electrostatic discharge and EMC
- Superior cable shield termination with integrated banding platform
- Optional spring-loaded protective covers for environmental protection of junction boxes and switches
- Wide range of high speed Ethernet/network protocols supported, including USB 2.0 and RJ45

## USB AND RJ45 SuperSeal™ Ruggedized Bayonet and Reverse-Bayonet Connectors



### Product Selection Guide



**SuperSeal™ 5015 Reverse Bayonet Plug with Cat 5e RJ45 Plug and Rear Crimp Contact Termination**



**SuperSeal™ 5015 Reverse Bayonet Plug with Cat 5e RJ45 Plug and Pre-Terminated Pigtail**



**SuperSeal™ 5015 Reverse Bayonet Receptacle with Cat 5e RJ45 Jack and Pre-Terminated Pigtail**



**SuperSeal™ 5015 Reverse Bayonet Receptacle with Cat 5e RJ45 Jack and PCB Termination**



**SuperSeal™ 5015 Reverse Bayonet Receptacles with Cat 5e RJ45 Jack/Jack Couplers**



**SuperSeal™ Reverse Bayonet RJ45 Connectors Cable Clamps, Cable Glands, and Backshells**

### PRODUCT SPECIFICATIONS

#### MATERIAL AND FINISHES:

Shell/coupling – High strength Aluminum alloy  
 Plating – Electroless Nickel, Cad O.D., Black Zinc Cobalt or Std. black electrodeposited paint  
 Bronze, stainless steel and other materials and finishes available. Please consult factory.

#### SHELL TYPE AND SIZES:

Shell Type – D5015 Reverse-Bayonet Type  
 Sizes – Shell size 18

#### CONNECTOR STYLES:

Receptacle – MIL-DTL-5015 type in shell size 18 with integrated RJ45 jack/jack or jack/PCB coupler available in Cat 5e  
 Plug – MIL-DTL-5015 type plug in shell size 18 with integrated RJ45 plug/jack coupler available in Cat 5e

Available in square flange front or rear wall mount with slotted or round holes, jam nut front or rear wall mount, in-line, and feedthrough configurations.

#### TECHNICAL CHARACTERISTICS:

Category – Cat 5e  
 Connection – 10BASE-T, 100BASE-TX, 1000BASE-T  
 Max Current Rating – 1.5 Amps at 20° C  
 Dielectric Withstanding Voltage – 1000 volts  
 Working Temperature – -40° to +85° C  
 Environmental Rating – IP67 unmated

#### TERMINATION OPTIONS:

Crimp contact and PCB termination, pre-terminated pigtails; jack/jack and jack/plug RJ45 configurations





Train	To	Status	Track	Time	Number Train
REGIONAL	BOSTON	ON TIME		9:24A	5227
HUTTLE	SPRINGFIELD	ON TIME		9:30A	
INDIRECT	MONTCLAIR	ON TIME		9:35A	
8:47A	3227 NJCOAST SEC EWR	ON TIME		9:37A	3831
8:52A	3927 NE CORR SEC EWR	ON TIME		9:43A	3231
9:07A	3929 NE CORR SEC EWR	ON TIME		9:45A	281
9:11A	3829 NE CORR SEC EWR	ON TIME		9:46A	6619
9:17A	6317 MID DIRECT SEC	ON TIME		10:00A	2153



# Octobyte™

## The faster 4/8 pole interconnect system for industrial Ethernet data applications

Glenair series ITH connector with Octobyte™ contacts is available with fully dedicated Ethernet protocol or in a combo version where a mix of signal-power and Ethernet is required. RoHS compliant, IP67 (IP68 on request) exceeds performance expectations typical in harsh environmental applications found throughout rail and industrial markets.

OCTOBYTE™ contacts are vibration resistant and designed to work with Ethernet cables from CAT 5 to CAT 7A, MVB-WTB, RG58 Coax.

ITH connectors with Octobyte™ contacts are easy and fast to assemble, making them the best solution for harsh-environment applications where signal reliability is a must.



Tested for compliance according to EN50173-1 standards set for CAT5E and CAT7. Testing was conducted using 12 jumpers, each 7.5 meters in length for a total of 90 meters.



- Commuter rail
- Passenger information systems (audio/video/digital displays)
- Monitoring and control (braking/doors/lighting/data)
- Heavy industry
- Data control
- Safety systems
- Tested in accordance with:
  - ISO F0 STP: CAT 7A
  - EN50173-1 F600-STP: CAT 7
  - EN50173-1 D STP: CAT 5E

## OCTOBYTE The faster 4/8 pole industrial Ethernet interconnect system



### ETHERNET CAT 7A CONTACTS



Data Transmission Ethernet Contacts for	Ethernet CAT 6A Ethernet CAT 7 Ethernet CAT 7A
Featuring	Internal crimpable contacts Inspectable contact Integrated cable clamp Low mating force
Technical Characteristics	Current rating 5A max Voltage drop (at 5A and 25°C) 70mV max
Materials and Finish	Copper alloy and gold plating
Inserts	Thermoplastic resin

### ETHERNET CAT 5 CONTACTS



Data Transmission Contacts for	Ethernet CAT 5 Ethernet CAT 5E Ethernet CAT 6 Ethernet CAT 6A
Featuring	Internal crimpable contacts Inspectable contact Integrated cable clamp Low mating force
Technical Characteristics	Current rating 5A max Voltage drop (at 5A and 25°C) 70mV max
Materials and Finish	Copper alloy and gold plating
Inserts	Thermoplastic resin—UL94V0-NFF 16-102 12F3 Exigence 3

### COAX CONTACTS



Data Transmission Contacts for	RG58
Featuring	Internal crimpable contacts Inspectable contact Integrated cable clamp Low mating force
Technical Characteristics	Current rating 5A max Voltage drop (at 5A and 25°C) 70mV max
Materials and Finish	Copper alloy and gold plating
Inserts	PTFE

### ETHERNET MVB - WBT CONTACTS



Data Transmission Contacts for	MVB - Multifunctional Vehicle Bus WTB - Wired Train Bus
Featuring	Internal crimpable contacts Inspectable contact Integrated cable clamp Low mating force
Technical Characteristics	Current rating 5A max Voltage drop (at 5A and 25°C) 70mV max
Materials and Finish	Copper alloy and gold plating
Inserts	Thermoplastic resin—UL94V0-NFF 16-102 12F3 Exigence 3



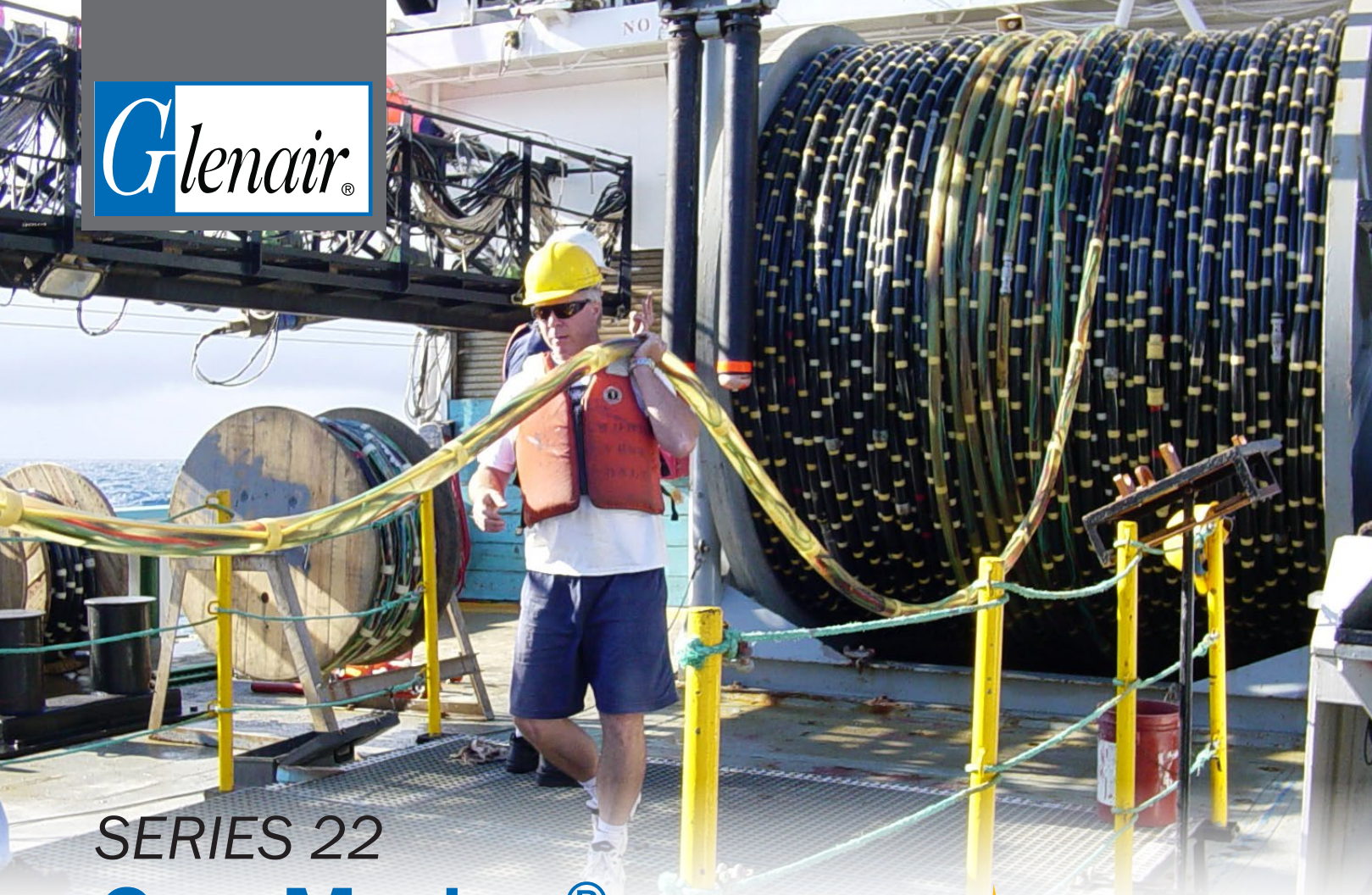

SERIES 22

# Geo-Marine®

## High-pressure harsh-environment connectors and overmolded cables for towed array and other high-pressure/submersible applications

Designed for use in oceanographic, geophysical and other severe industrial environments, Glenair Series 22 Geo-Marine® Connectors and Cables are the ultimate harsh-environment power and signal connector solution. Built to withstand hydrostatic pressures up to 5,000 PSI and exposure to extreme temperatures and corrosives, the Series 22 Geo-Marine® is ideally suited for applications such as US Navy towed array sonar systems, military land vehicles, submersibles and ROV's, offshore-oil drilling equipment, seabed exploration, pipeline inspection systems, well monitoring equipment, and digital seismic streamers.

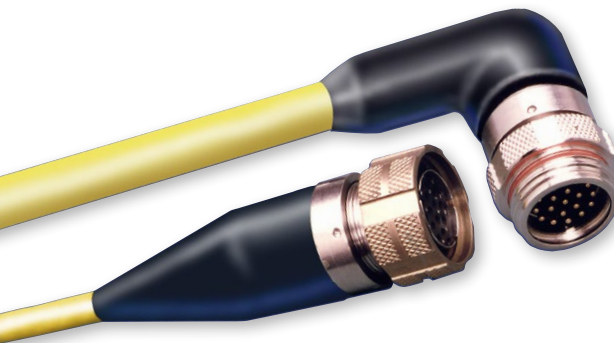

Geo-Marine® plugs are equipped with arctic coupling nuts—made from marine-grade naval bronze—with easy-to-grip castellated knurling and a powerful ratcheted anti-decoupling mechanism which guarantees reliable mating and demating performance in even the harshest environments. Supplied as discrete connectors—or more typically in build-to-print overmolded cable assemblies.



- Marine Grade 316 stainless steel machined shells and Naval Bronze coupling rings
- High-pressure environmental and hermetically sealed receptacles for field applications
- Power and signal contact arrangements from 2 to 128 contacts
- Anti-vibration ratcheted coupling nuts with castellated knurling
- Available Viton® overmolded cable assemblies

## SERIES 22 Geo-Marine® Connectors

### High-pressure environmental and hermetic connectors



photo: Seismometer, geophysical observatory, Neumayer Station, Antarctica by Dr. Hannes Grobe



### Anti-Galling Arctic Coupling Nuts

One of the most valuable features of the Series 22 Geo-Marine® from the user's perspective is the specially-designed castellated and knurled coupling nut which facilitates rapid mating and demating in field applications. Single-start, stub Acme threads reduce thread fouling and binding, and are supplied with an anti-vibration/anti-decoupling device which prevents accidental loosening or decoupling. Plugs contribute to high-pressure sealing, up to 5,000 PSI in the mated condition, by means of rugged and durable interfacial and peripheral seals.



### Range of Offerings

Series 22 Geo-Marine® connectors are supplied with either fused-glass ("H" hermetic class) or high grade thermoplastic ("E" environmental class) insulators. Both classes of connectors are supplied with rugged, corrosion-resistant materials. Low-profile and scoop-proof cable plugs and receptacles, as well as bulkhead feed-throughs are available. Specially-designed cable sealing backshells as well as EMI/RFI shield termination backshells and environmentally-sealed protective covers complete the range of discrete product offerings. 35 insert arrangements (contact sizes #12, #16, #20 and #22) are tooled and fully available.

**Receptacle Configurations:** High-pressure environmental ("E") and hermetic ("H") class receptacles are available for cable as well as box applications. Rugged o-ring piston seals located inside the receptacle barrel contribute to reliable high-pressure sealing in the mated condition. Glenair is able to supply Geo-Marine® customers with a wide range of receptacle configurations for unique requirements including low-profile and scoop-proof designs, pin and socket contact designs, solder cup and printed circuit board termination, unique flange shapes and mounting configurations, in-line cable receptacles, connector savers and gender changers.

### HIGH-PRESSURE ENVIRONMENTAL AND HERMETIC RECEPTACLE CONFIGURATIONS

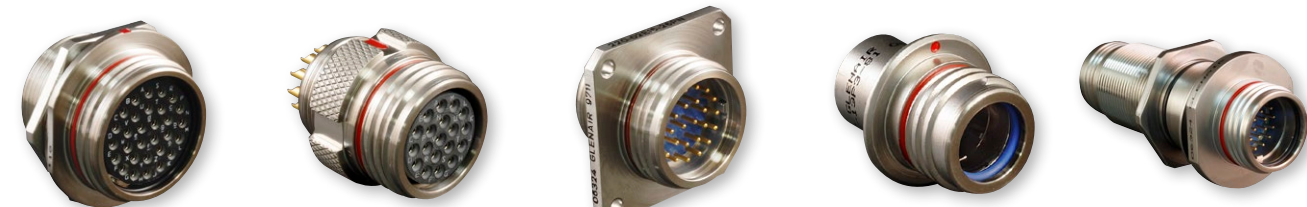

Jam Nut      In-Line      Square Flange      Solder-Mount      Bulkhead Feed-Through

D





# MARINE BRONZE Seacrow Connectors

## For geophysical/offshore and other harsh-environment applications

Glenair manufactures connectors qualified to VG96929, VG95234 and VG95328 standards. These connectors are mostly used in harsh-environment military applications for ground vehicles and ground systems. Our new Marine Bronze version increases the level of robustness of these connectors to be successfully used in all severe environment navy installations, as well as offshore platforms, sea ports, geological and oceanographic applications.



- Marine bronze alloy for superior corrosion resistance in seawater and other harsh environments
- Ideal for shipboard and offshore drilling applications
- Available in Series ITS (5015 reverse-bayonet), Series IPT (26482), Series IGE (Single-pole high-power VG95234) and Series IT (5015 threaded)
- IP67 environmental sealing in mated condition; IP68 available
- Hundreds of available contact arrangements for both power and signal as well as hybrid applications

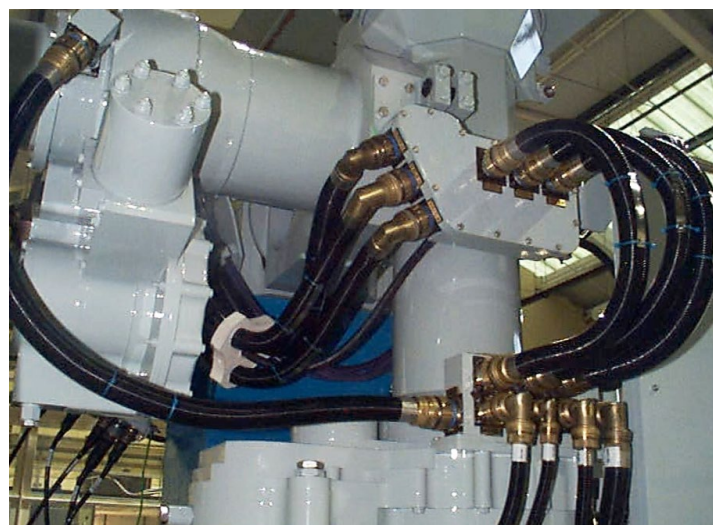

## HARSH ENVIRONMENT Seacrow Marine Bronze Connectors Superior corrosion resistance



### ITS-MB REVERSE-BAYONET CONNECTORS



#### VG95234 Compliant Marine Bronze Series

ITS-MB connectors are compliant with VG95234, using all the same insert arrangements available in the standard ITS Reverse Bayonet Connectors catalogue. Typically they are used for power and signal transmission, with wires from 26 AWG to 4/0. A wide variety of backshells allow the ITS-MB to accept jacketed cables, single or multi-poles, with or without RFI/EMI shielding, conduits with PG or metric thread. IP67 protection is the standard performance. IP68 on request.

### IPT-MB MIL-DTL-26482 HIGH DENSITY CONNECTORS



#### VG95328 Compliant Marine Bronze Series

IPT-MB connectors are the choice for reliability when 20-16 AWG signal cables are used. The insert arrangements as well as the electrical characteristics are detailed in the IPT IPT-SE Catalogue. Backshells suitable for EMI shield terminations and heat shrink boots are also available. The receptacle is also available with PCB contacts. IP67 protection is the standard performance. IP68 on request.

### IGE-MB REVERSE-BAYONET SINGLE-POLE CONNECTORS



#### VG96929 Compliant Marine Bronze Series

IGE-MB High Power Single Pole Connectors are used with cables from 16 to 240 mmq. These connectors achieve high-performance working current and peak current, and are ideal for engines, power supplies, and power distribution boxes. Several backshells are available, either straight or 90° elbows for the most reliable cable accommodation. See the VG96929 Catalogue for detailed electrical characteristics. IP67 protection is the standard performance. IP68 on request.

### IT-MB MIL-C-5015G THREADED CONNECTORS



#### Marine Bronze Series

IT-MB is a threaded connector compliant with the MIL-DTL-5015 standard. All the electrical characteristics are available in the IT standard catalogue. IT-MB family is a threaded version mostly used for power and signal, with IP67 standard performance sealing.





# Rectangular Connectors

From nano and micro to D-subminiature—the industry's best performance and availability

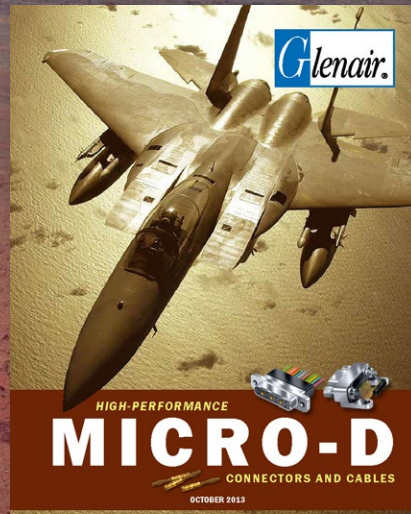
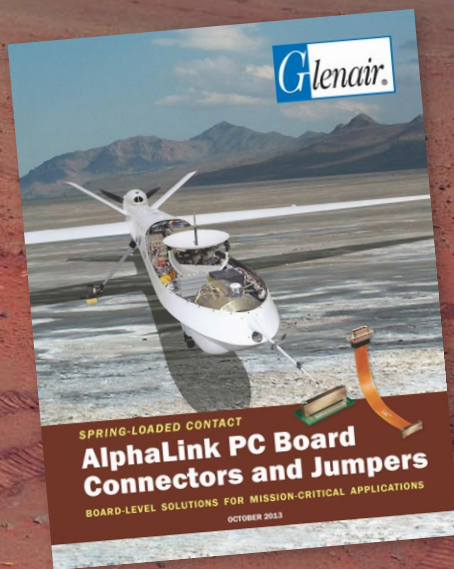

Glenair manufactures all of the popular industry-standard rectangular connectors used in military and aerospace applications, including special high-performance versions of the M24308 D-Sub and our revolutionary Series 79 Micro-Crimp connector. We offer a small form factor rectangular connector for virtually every I/O and wire-to-board requirement including MIL-DTL-83513 Micro-D subminiatures and MIL-DTL-32139 Nanominiature. All of our rectangular connector products are available in filter and hermetic versions, as well as with flex circuit terminations. Point-to-point cordsets, pigtailed, and build-to-print harnesses are Glenair specialties.

## Rectangular Connector Selection Guide

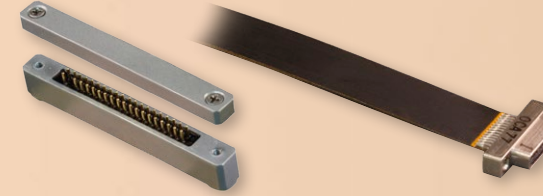

AlphaLink® Board-Level Connectors and Flex Jumpers



Series 89 MIL-DTL-32139 Nanominiature Connectors

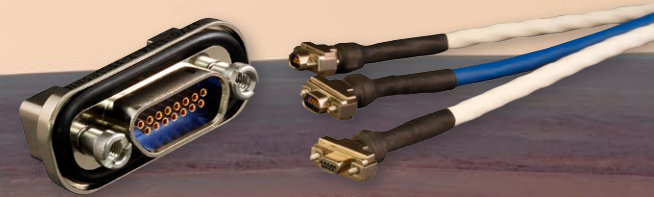

Micro-D (MIL-DTL-83513) Connectors and Cable Assemblies



MasterLatch® Quick-Disconnect Micro-D

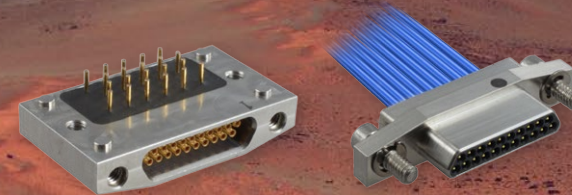

Well-Master™ 260° High-Temperature Micro-D



Series 79 Micro-Crimp Connectors



SuperTwin™ Lightweight Composite Modular Connectors



Series 28 HiPer-D 24308 Compatible Connectors



Complex Multi-Branch Micro Rectangular Harnessing is a Glenair Specialty



For more information contact Glenair at 818-247-6000 or visit our website at [www.glenair.com](http://www.glenair.com) U.S. CAGE code 06324





SERIES 171

**AlphaLink**

## Board-level spring-loaded-contact connectors and turnkey flex jumpers

AlphaLink SL is a high-performance, solderless board-level connector technology developed by Glenair that significantly expands board-level interconnection options for users of mil-spec caliber connectors. Precision-machined and EMI shielded, these ultra lightweight PC tail, solder cup, and/or pigtail equipped connectors are designed for high-reliability applications that require avionic system levels of vibration and shock tolerance. Ultra low-profile and high-density, AlphaLink SL connectors are equipped with 2–3 Amp spring-loaded contacts and may be ordered either as discrete connectors or in turnkey flex jumpers with Glenair high-reliability I/O connectors. Glenair is perfectly positioned to provide the entire solution with in-house manufacturing for every component part—from contacts and connectors to rugged polyimide-based flex. AlphaLink SL flex jumpers are available with Series 80 Mighty Mouse and Series 88 SuperFly ultraminiature and nanominiature circular connectors, as well as Micro-D subminiature, Series 79 Micro-Crimp, and nanominiature rectangular connectors. A wide range of insert arrangements, from 4–40 contacts is available.

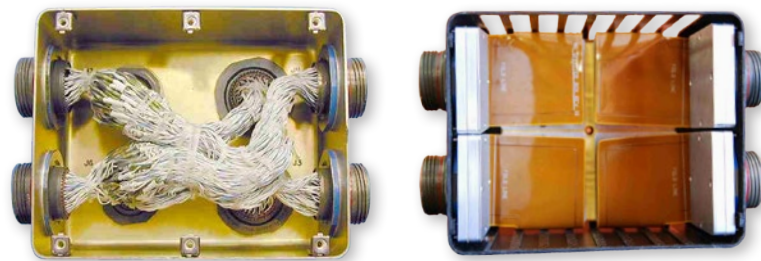

Flex offers many advantages over conventional wire, including reduced size, weight, and complexity.

- **Spring-loaded, solderless board-level connector**
- **PC tail and solder cup versions offer easy termination to flex or wire**
- **Turnkey I/O-to-board flex and pigtail wire jumpers**
- **Lightweight and low-profile—up to 40% space savings compared to 2mm pitch solutions**
- **High-density .050" center-to-center contact footprint**
- **Fast PC board integration with reduced board preparation and masking**
- **Withstands temperature, vibration and shock extremes**

## SERIES 171 ALPHALINK SL Spring-loaded contact board-level connector Fast and easy PC board integration



New!  
AlphaLink SL  
board-level  
spring-loaded  
contact  
pre-wired  
pigtail  
assemblies

### AlphaLink SL Spring-Loaded Contact Interface

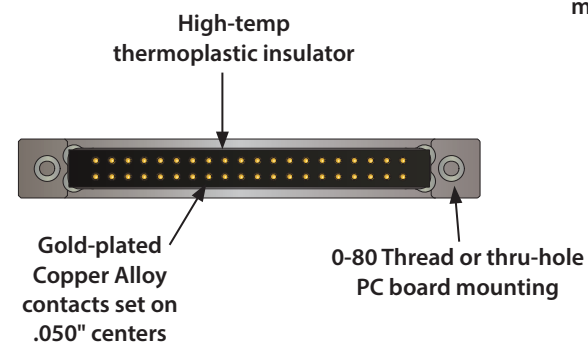

### 171-134-01 Solder Cup Termination

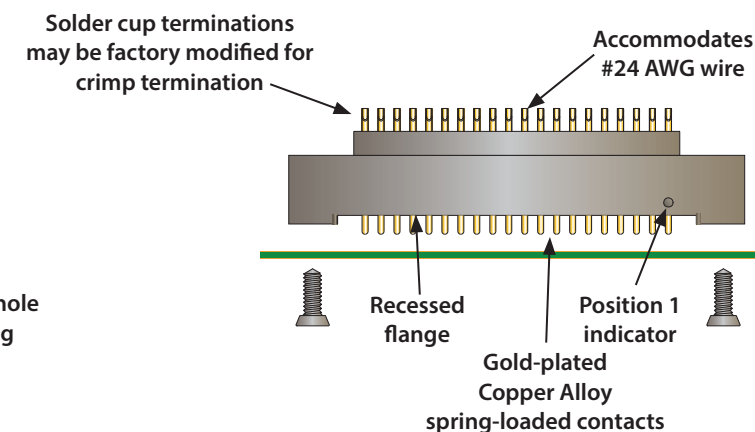

### 171-134-03 Wire Pigtail Termination

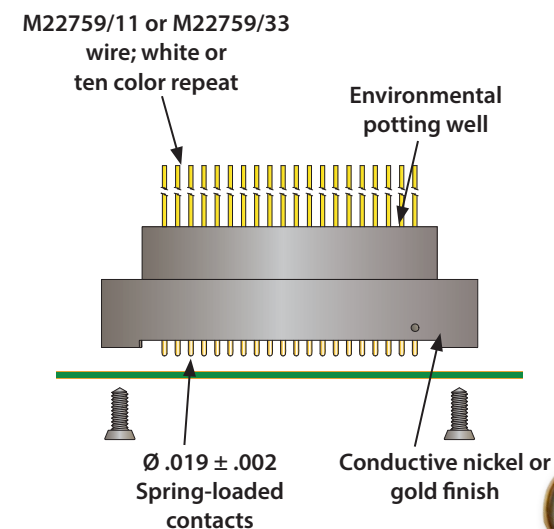

### 171-134-02 PC Tail Termination

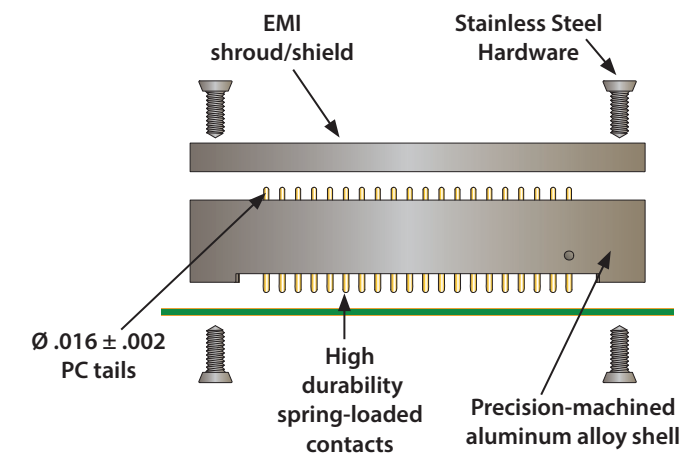

AlphaLink SL spring-loaded contact PC board connectors deliver up to 50% footprint savings versus conventional 2mm pitch solutions. PC tail equipped connectors, the 171-134-02, are supplied with an EMI shroud / shield for improved EMC compared to low-cost plastic board connectors. All connector styles incorporate a high-reliability spring-loaded contact that delivers a virtually unlimited number of mating cycles. Connectors are typically mated to the PC board using conductive pads or via's. Stainless steel mounting hardware provides a robust, vibration-resistant attachment solution compared to stamped-and-formed retention bars.

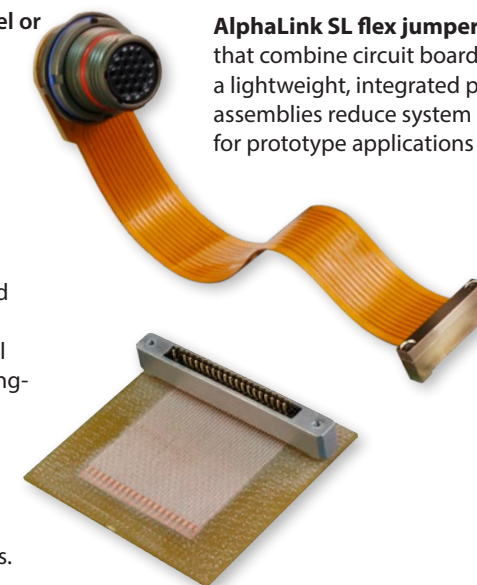

**AlphaLink SL flex jumpers:** Compact interconnect assemblies that combine circuit board technology and cabling into a lightweight, integrated package. These turnkey jumper assemblies reduce system size and weight and are ideally suited for prototype applications and new product development efforts.

**Glenair**

For more information contact Glenair at 818-247-6000 or visit our website at [www.glenair.com](http://www.glenair.com) U.S. CAGE code 06324



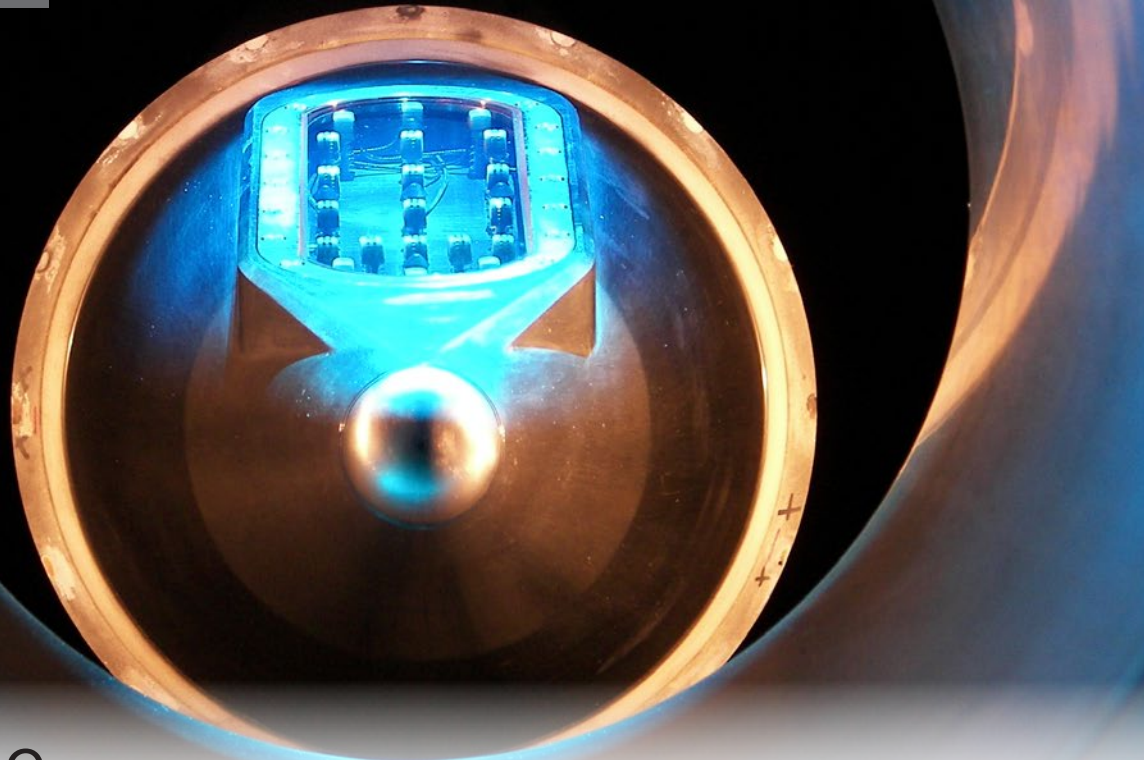

# SERIES 89 Nanominiature Connectors

MIL-DTL-32139 qualified connectors for mission-critical board-to-wire applications— simply the smallest and lightest mil-spec connector in the business



- 1 Amp current rating
- .025 Inch (0.635 mm) contact spacing
- #30 And #32 gage wire accommodation
- Single and double row
- Metal shell, aluminum, titanium or stainless steel
- TwistPin contact system
- Gold alloy contact, unplated
- Thru-hole and surface-mount PCB versions

## THE NANO TWISTPIN ADVANTAGE

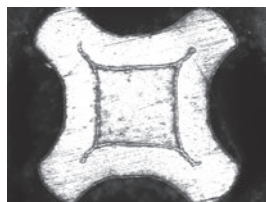

Transverse cross-section of a TwistPin contact crimped to solid wire



- Gas-Tight Crimp Joint
- Better Shock and Vibration Performance
- Corrosion Proof Contact Alloy

Nanominiature sized circular connectors in threaded and push-pull styles are also now available from Glenair



## SERIES 89 Nanominiature Connectors

The smallest and lightest mil-spec connector



### Series 89 Nanominiature Connector Performance Summary

Contact Spacing	.025" (0.64mm) Contact Centers
Wire Accommodation	#30-#32 AWG
Current Rating	1 AMP Max
DWV	250 VAC RMS Sea Level
Insulation Resistance	5000 Megohms Minimum
Operating Temperature	-55° C. to +125° C.
Contact Resistance	71 Millivolt Drop Maximum
Shock, Vibration	100g's, 20 g's
Durability	200 Mating Cycles
Corrosion Resistance	48 Hours Salt Spray
Mating Force	5 Ounce Max, 0.4 Ounce Min

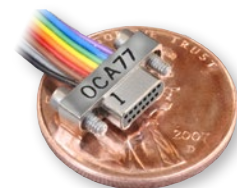

Glenair nanominiature connectors are MIL-DTL-32139 qualified. Series 89 products offer options not covered in the mil-spec.

### How Small Are They?



**D-Subminiature Connector**  
25 Contacts  
on 0.109 Inch Spacing



**Micro-D Connector**  
25 Contacts  
on 0.050 Inch Spacing



**Nano Connector**  
25 Contacts  
on 0.025 Inch Spacing

## SERIES 89 NANOMINIATURE PRODUCT SELECTION GUIDE

Pre-Wired Single Row Connectors

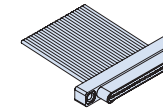

Insulated Wire

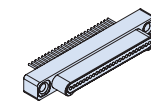

Uninsulated Wire

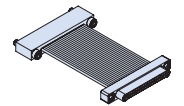

Back-to-Back Cables

Pre-Wired PCB Connectors

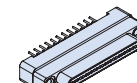

Thru-Hole Vertical

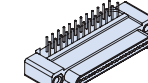

Thru-Hole 90°

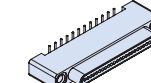

SMT 90°

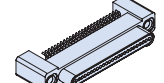

SMT 90°

Pre-Wired Double Row Connectors

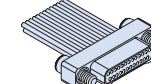

Insulated Wire

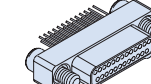

Uninsulated Wire

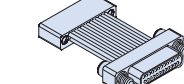

Back-to-Back Cables

Double Row PCB Connectors

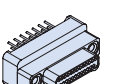

Thru-Hole Vertical

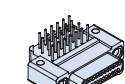

Thru-Hole 90°

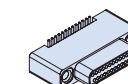

SMT 90°

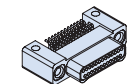

SMT 90°

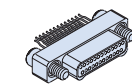

SMT Straddler

Pre-Wired MIL-DTL-32139 Connectors

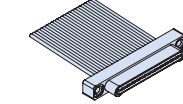

Single Row, Insulated Wire

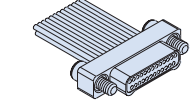

Double Row, Insulated Wire

## NANOMINIATURE CONTACT ARRANGEMENTS

Double Row Mating Face of Pin (Plug) Connector

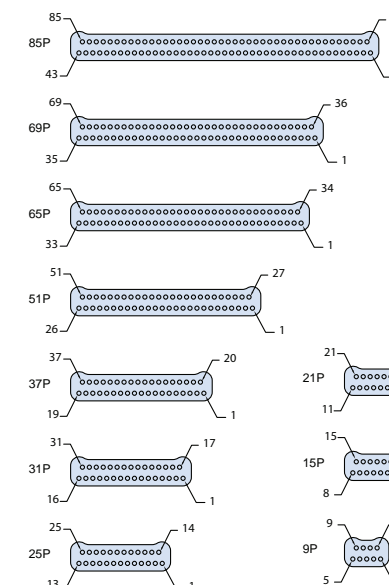

Single Row Mating Face of Pin (Plug) Connector

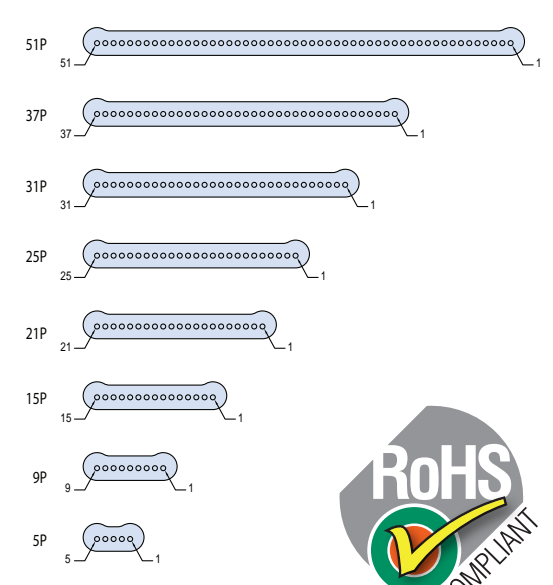





SERIES MWDM

# Micro-D Connectors



Standard

Hermetic

EMI Filter

TwistPin equipped MIL-DTL-83513 Micro-D connectors offer outstanding mating performance, durability and minimal contact resistance



- High density Micro TwistPin contacts set on .050 centers
- 9 to 130 contact arrangements
- Pigtail, PCB, solder cup, and flex terminations
- Single row, multi-row, low profile and high density insert arrangements
- QPL and commercial versions
- Same-day availability on all part numbers

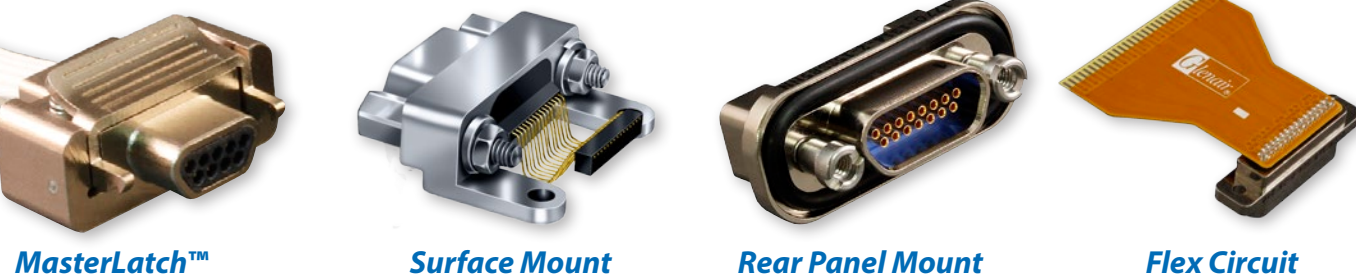

MasterLatch™

Surface Mount

Rear Panel Mount

Flex Circuit

MIL-DTL-83513 AND COMMERCIAL  
Micro-D Connectors  
Mission-critical mating performance



## METAL SHELL MICRO-D FOR HARNESSING APPLICATIONS

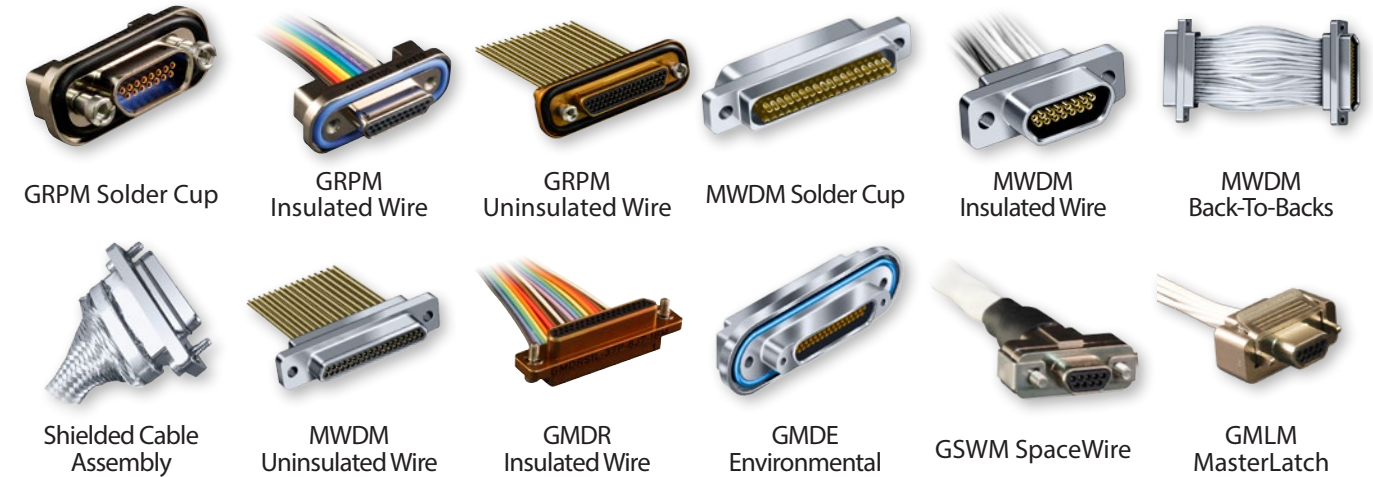

GRPM Solder Cup

GRPM Insulated Wire

GRPM Uninsulated Wire

MWDM Solder Cup

MWDM Insulated Wire

MWDM Back-To-Backs

Shielded Cable Assembly

MWDM Uninsulated Wire

GMDR Insulated Wire

GMDE Environmental

GSWM SpaceWire

GMLM MasterLatch

## MICRO-D FOR PRINTED CIRCUIT BOARD



GRPM-CBS

GRPM-CBR

MWDM-BS

MWDM-BR

MWDM-CBR

MWDM-CBS

90° Surface Mount

GMR7580

GMR7590

GMR7580C

GMR7590C

Right Angle Filter

WellMaster™ 260

Sav-Con®

Latching MicroStrip

Low Profile



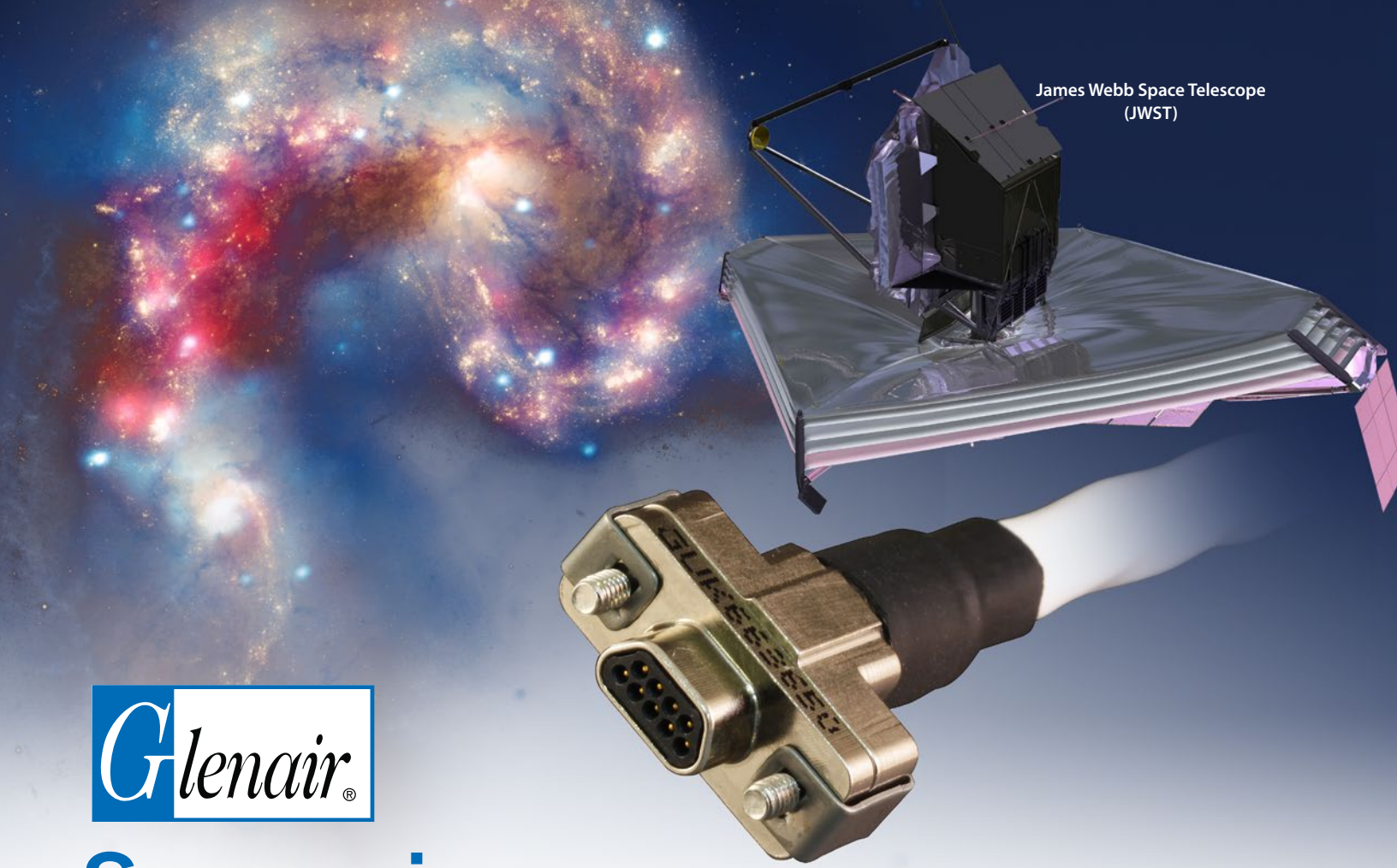

James Webb Space Telescope (JWST)



# Spacewire

## Reduced Cost of Ownership, Easy Integration, and High-Performance for Flight and Lab Grade Cable Assemblies.

The success of any space mission begins with reliable data transmission and Glenair Spacewire cables, built to meet the strict standards set forth by ECSS-E-ST-50-12C, make this a reality. Our Spacewire cables offer bidirectional, high speed data transmission rates up to 400 Mbits/s while significantly reducing cross talk, skew, and signal attenuation. By incorporating a serial, point-to-point cable, with low voltage differential signaling (LVDS) reduced costs are realized through an easily integrated data transmission cable. These features allow Spacewire cables to be incorporated across various satellite programs without the expense of costly design customization.

## Spacewire: The Space Industry Data Transmission Standard

Glenair Spacewire assemblies begin with a high performance cable built with expanded polytetrafluoroethylene (ePTFE) insulation. This material allows for low-loss transmission of LVDS signals maximizing data-rates while allowing for the implementation of standard hardware protocols, thus eliminating the need for design customization and long lead time cable projects.

### TYPICAL USES INCLUDE

- EGSE applications
- Radar sensor systems
- Hi-resolution camera equipment
- Sensor, mass-memory unit, and telemetry subsystem interconnections

### APPROVED FOR USE BY:

- ESA
- NASA
- JAXA
- RKA

### CONNECTOR/CABLE

- Laboratory and Space Grade Versions Available
- Qualified MIL-DTL-83513 Micro-D Connector
- Gold Plated Copper Alloy TwistPin Contacts
- Basic Cable, 4 Twisted Pair Cables and a Ground
- Epoxy Resin Potting
- EMI Banding Backshell

### PERFORMANCE

- 3 Amps
- Temperature Tolerance -200°C to +180°C
- 100 Ω Impedance Shielded Signal Pair
- Very Low Skew, Signal Attenuation and Cross Talk
- 65dB Minimum Attenuation Shielding Effectiveness
- Low Magnetic Permeability IAW EIA-364-54

# Spacewire

## Technical specifications • How-to-order

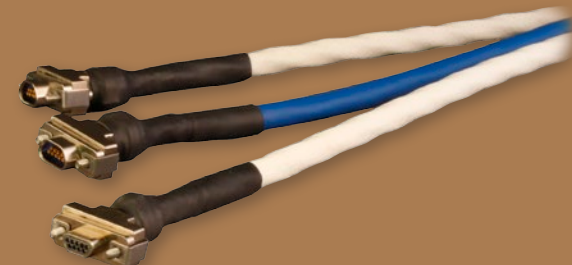

### NOTES:

1. Flight grade (cable Type F) assemblies to be screened IAW NASA EEE-INST-002, Table 2. Level 1 with 100% thermal vacuum outgassing (24 hours/+125°C/10<sup>-6</sup> torr). Reference Glenair Mod Code 429C.
2. Operating temperature - 200°C to +180°C. Reference Glenair Mod Code 428.
3. Electrical performance: Dielectric withstanding voltage: 600 VAC. Insulation resistance: 5000 megohms @500 VDC.
4. Assembly to be identified with Glenair's name, Part Number, Cage Code and Date Code or ESCC Component Part Marking Standards.

### MATERIALS/FINISH:

- Shells/backshells - aluminum alloy/electroless nickel.
- Insulators - high grade rigid dielectric/N.A.
- Contacts - copper alloy, gold plated.
- Hardware - stainless steel/passivated.

Back To Back Wiring Diagram (GP)

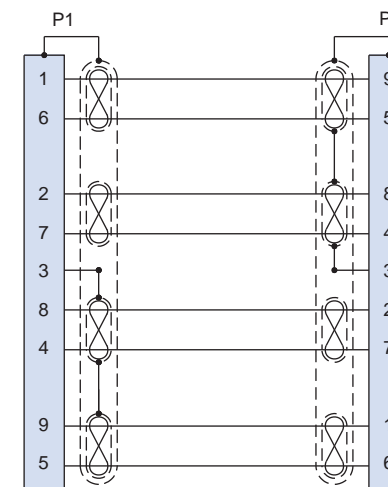

Single Ended Wiring Diagram (P)

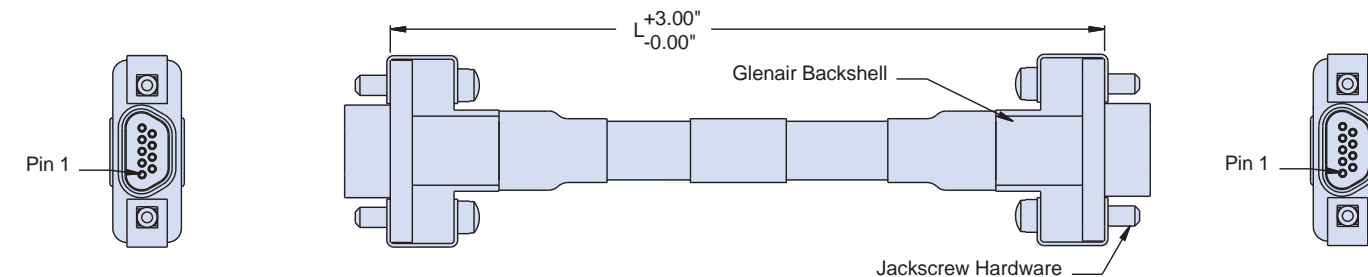
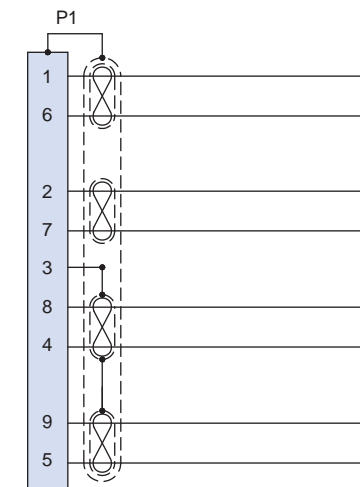

How To Order Spacewire*										
Sample Part Number	GSWM	2	L	-9	GP	-6	F	B	-16	S
Product Series	GSWM—Glenair Spacewire Micro-D									
Shell Plating	2—Electroless Nickel		5—Gold							
Insulator Material	L—LCP									
Shell Size	-9									
Connector Type	P—Single Ended Pin (Plug) GP—Pin (Plug) Connector Both Ends									
Wire Gauge	-6—26 AWG			-8—28 AWG			-0—30 AWG (30 AWG—Lab Only)			
Cable Type	F—Flight Grade					L—Lab Grade				
Termination Option	B—Backshell									
Cable Length In Inches	-16 = 16 inches (12 inches minimum)									
Hardware	S—Male Slotted Jackscrew					P—Female Jackpost				

\*Use Mod Code 428 for high-temp version and Mod Code 429C for NASA thermal outgassing





SERIES GMLM  
MasterLatch®

MasterLatch®

Quick-disconnect Micro-D

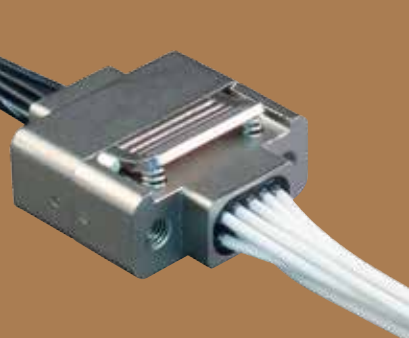

MasterLatch®

SERIES GMLM

MasterLatch®

Quick-disconnect Micro-D

MasterLatch (GMLM) Quick-release locking Micro-D connector pairs are equipped with a precision latching and locking mechanism. The single thumb latch on the plug side actuates a pair of locking latches that mate quickly and reliably to GMLM receptacles. These TwistPin equipped, low-insertion-force connectors meet all the standard performance requirements of MIL-DTL-83513 including vibration, shock, and mating durability. Choose from 6 different insert arrangements, with 9 to 37 contacts. The unique ergonomic latching mechanism can be easily activated with a thumb and forefinger grip even when wearing gloves, or when difficult access to connector pairs makes the use of jacking hardware and tools impossible.

- Precision latch meets MIL-DTL-83513 vibration and shock
- Low insertion force TwistPin contacts
- Easy-to-activate latching mechanism

Face view pin connector - Micro-D contact arrangements

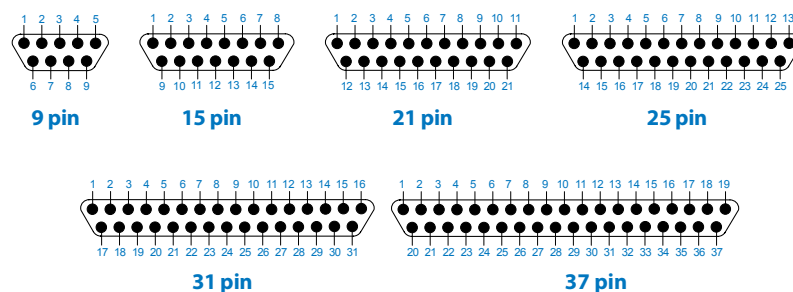

How To Order GMLM MasterLatch™									
Sample Part Number	GMLM	2	L	-25	P	-6	K	7	-18
Product Series	GMLM Glenair MasterLatch™ Micro-D								
Shell Plating	1 - Cadmium 2 - Nickel 4 - Black Anodize 5 - Gold 6 - Chem Film								
Insulator Material	L - LCP or PPS								
Contact Layout	9, 15, 21, 25, 31, 37								
Connector Type	P - Pin Connector S - Socket Connector								
Wire Gauge	4 - 24 AWG 6 - 26 AWG 8 - 28 AWG 0 - 30 AWG (30 AWG-Lab Only)								
Wire Type	K - M22759/11 600 Vrms Fluoropolymer (TFE) J - M22759/33 600 Vrms Modified Cross-Linked Tefzel (ETFE)								
Wire Color Code	1 - White 2 - Yellow 5 - Color Coded 7 - Ten Color Repeating								
Cable Length In Inches	18 - 18 inches								

Series GMLM MasterLatch™ Dimensions							
	Pin			Socket			
Layout	A Max	B Max	C	D Max	E Max	F Max	G
9P	0.785	0.333	0.320	0.610	0.290	0.400	0.183
9S	0.785	0.342	0.320	0.429	0.295	0.400	0.183
15P	0.935	0.483	0.320	0.610	0.290	0.550	0.183
15S	0.935	0.492	0.320	0.429	0.295	0.550	0.183
21P	1.085	0.633	0.320	0.610	0.290	0.700	0.183
21S	1.085	0.642	0.320	0.429	0.295	0.700	0.183
25P	1.185	0.733	0.320	0.610	0.290	0.800	0.183
25S	1.185	0.742	0.320	0.429	0.295	0.800	0.183
31P	1.335	0.883	0.320	0.610	0.290	0.950	0.183
31S	1.335	0.892	0.320	0.429	0.295	0.950	0.183
37P	1.485	1.033	0.320	0.610	0.290	1.100	0.183
37S	1.485	1.042	0.320	0.429	0.295	1.100	0.183

MasterLatch™ GMLM connectors are sold as prewired pigtailed only, with 18 inch wire leads. Contact factory for alternative lengths.

**MATERIAL AND FINISH**

- Insulator: Liquid crystal polymer or PPS
- Wire: M22759/11 600 Vrms Fluoropolymer (TFE) or M22759/33 600 Vrms Modified Cross-Linked Fluoroplastic (ETFE)
- Pin Contacts: Gold-plated beryllium copper alloy
- Socket Contacts: Gold-plated phosphor bronze alloy
- Shell: Aluminum alloy with choice of cadmium plate, electroless nickel, black anodize, gold, or chem film
- Latching mechanism: Stainless steel



For more information contact Glenair at 818-247-6000 or visit our website at [www.glenair.com](http://www.glenair.com) U.S. CAGE code 06324





# HIGH-TEMPERATURE Well-Master™ 260°



## The Micro-D connector for serious, high-temperature applications

Standard Micro-D connectors are rated for +125°C. Glenair's MWDM Micro-D can withstand +150°C continuous operating temperature and can be upgraded to +200°C if assembled with special high temperature epoxies. But oil, gas and geothermal wells can subject electronic instruments to temperatures as high as +260°C. The GHTM Series Micro-D meets the need for a high density, high performance connector capable of handling this temperature. The GHTM features contacts made from a special alloy that resists softening when exposed to temperatures up to +260°C (500° F). Rugged passivated stainless steel shells and hardware, high temperature liquid crystal polymer (LCP) insulators allow these connectors to survive the most demanding environments. Unique angled mounting ears allow the Well-Master™ 260° to fit in confined spaces.

- +260°C Operating Temperature
- Angled Mounting Ears to Fit in Small Diameter Instruments
- High Reliability TwistPin Contact System with Special High Temperature Alloy
- .050" Pitch Contact Spacing for Reduced Size
- Solder Cup, Pre-Wired or PCB

## Well-Master™ 260°

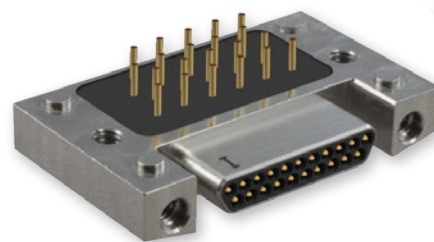

+260°C PCB Header



+260°C Cable Connector

## HIGH TEMPERATURE Well-Master™ 260°

### GHTM Micro-D connectors



In addition to extreme high temperature tolerance, and demating resistance to vibration and shock, the Glenair Well-Master™ 260° Micro-D connector features unique shell packaging designed to conform with the cylindrical shape of instrument housings. Special angled mounting ears facilitate incorporation of the connector into available space, and the Micro-D's overall reduced size compared to other rectangular connector solutions allows for more efficient utilization.

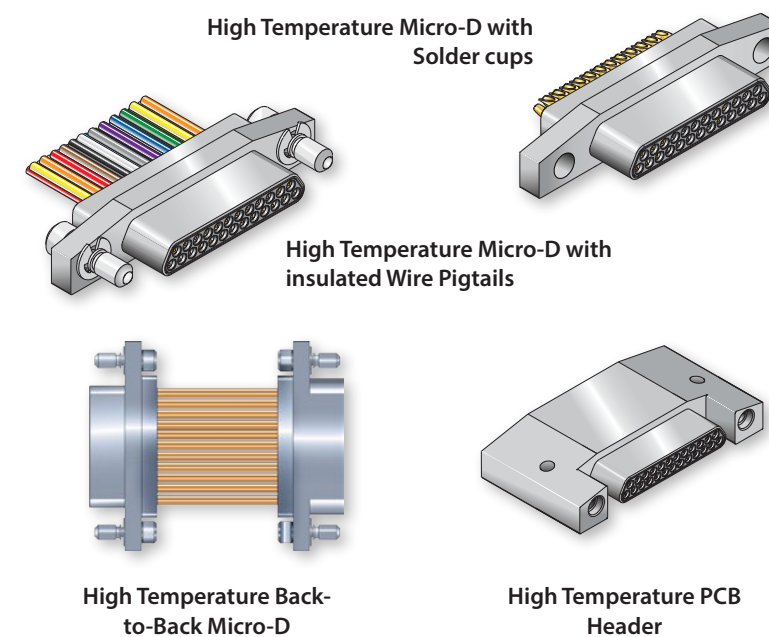

### GHTM HIGH TEMPERATURE CONTACT ARRANGEMENTS

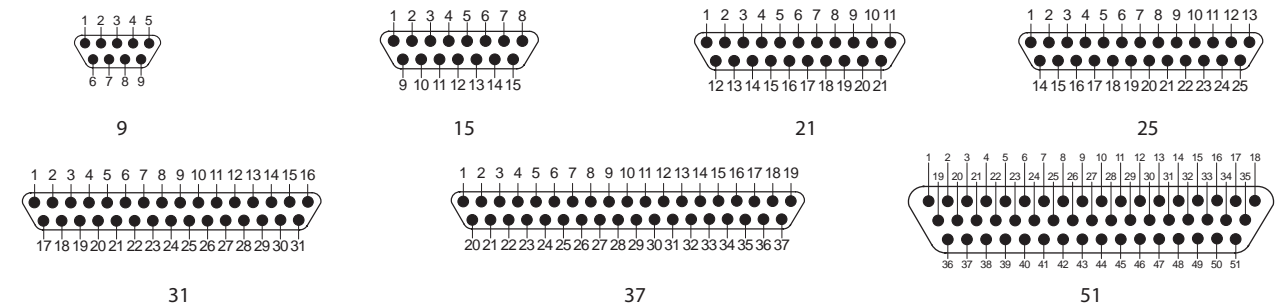

Mating face of pin connector. Socket connector contact numbers are reversed.

Materials and Finishes	
Contacts	Proprietary nickel alloy, gold plated
Insulators	Liquid crystal polymer (LCP)
Shell	Stainless steel, passivated
Mounting Hardware	Stainless Steel
Insulated Wire	Nickel-coated copper, PTFE insulation per M22759/87 (260°C)

Specifications	
Current Rating	3 Amps
Contact Resistance	8 milliohms maximum
Dielectric Withstanding Voltage	600 Vac sea level
Insulation Resistance	5000 megohms minimum
Operating Temperature	-55° C. to +260° C.
Shock	50 g.
Vibration	20 g.





SERIES 79

# Micro-Crimp

The ultraminiature crimp contact rectangular with advanced environmental and EMC performance

MICROCRIMP®

- Crimp, PCB, fiber optic, coax, power and pitot
- Precision machined aluminum shells sealed to IP67
- High-density #23 contact arrangements set on .076 centers
- Blind mating for rack and panel applications
- Environmental, hermetic and filter versions
- Integrated ground spring for improved EMI shielding

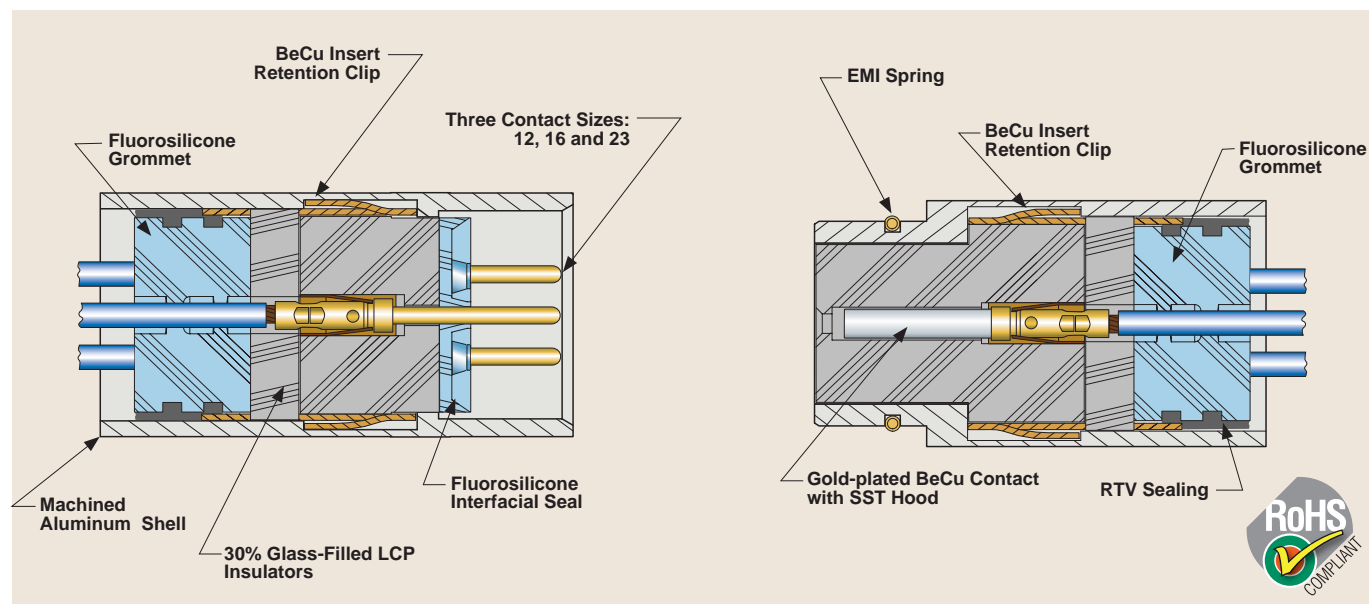

## SERIES 79 Micro-Crimp

High-reliability crimp contact performance

MICROCRIMP®

### SERIES 79 MICRO-CRIMP PRODUCT SELECTION GUIDE



Crimp Terminated Cable Connectors



Crimp Terminated Panel Mount Connectors



Straight PCB Panel Mount and Free-Standing Connectors



Right Angle PCB Panel Mount and Free-Standing Connectors



Backshells and Accessories, EMI Adapters and Protective Covers

#### Blind Mate Guide Pins and Sockets

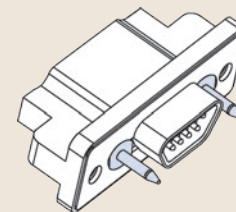

**Guide Pins**  
Connector may be supplied with stainless steel non-removable guide pins.

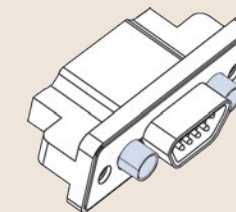

**Guide Sockets**  
Connector may be supplied with stainless steel non-removable bushings.

#### Selected Contact Types



Standard Signal

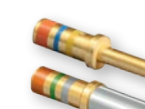

Power



Coaxial



Differential Twinax



Fiber Optic



Pitot Tube

Shell Size	Contact Arrangement	Contact Quantity		
		#23	#16	#12
<b>A</b>	A-5	5	—	—
<b>B</b>	B-2P2	—	2	—
	B-9	9	—	—
<b>C</b>	C-13	13	—	—
<b>D</b>	D-15	15	—	—
	D-3P3	—	3	—
	D-7P2	5	2	—
<b>E</b>	E-11P2	9	2	—
	E-19	19	—	—
	E-7P3	4	3	—

Shell Size	Contact Arrangement	Contact Quantity		
		#23	#16	#12
<b>F</b>	F-15P2	13	2	—
	F-23	23	—	—
	F-5P5	—	5	—
<b>G</b>	G-33	33	—	—
<b>H</b>	H-10P4	6	—	4
	H-29P7	22	7	—
	H-36P2	34	—	2
	H-54P2	52	2	—
<b>L</b>	L-5P5	—	—	5
	H-66	66	—	—

Shell Size	Contact Arrangement	Contact Quantity		
		#23	#16	#12
<b>J</b>	J-17P4	13	4	—
	J-25P2	23	2	—
	J-33	33	—	—
	J-7P7	—	7	—
<b>K</b>	K-27P4	23	4	—
	K-35P2	33	2	—
	K-43	43	—	—
	K-9P9	—	9	—
<b>L</b>	L-6P6	—	—	6
<b>L</b>	L-78	78	—	—
<b>M</b>	M-102	102	—	—

#### Performance Specifications

Current rating	Contact size #23 5 Amps, size #16 13 Amps, size #12 23 Amps maximum
Voltage rating (DWV)	Contact size #23 500 VAC rms. size #16 and #12 1800 VAC rms. Sea level.
Insulation resistance	5000 megohms minimum
Operating temperature	-65° C. to +150° C.
Contact resistance	5 milliohms maximum
Water ingress protection	IP67
Shielding effectiveness	>75 dB attenuation from 100 MHz to 1000MHz, >60dB 1GHz to 4GHz, >40dB 4GHz to 10GHz.



For more information contact Glenair at 818-247-6000 or visit our website at [www.glenair.com](http://www.glenair.com) U.S. CAGE code 06324





SERIES 20

# SuperTwin™

## Lightweight Composite Modular Connectors

Drop-in replacements for legacy modular rectangular connectors save weight, space, and assembly time

Today's high-performance commercial aircraft are looking for revolutionary materials and product designs that can reduce weight and improve reliability and performance. The Glenair Series 20 Super-Twin™ lightweight modular connector is a drop-in replacement for legacy cable and panel connectors that no longer meet these performance specifications—especially for ease of assembly, electromagnetic compatibility and size, weight and power optimization.

The Glenair Series 20 Super-Twin™ can accommodate a broad range of contact sizes and types from #23 to #8 signal, Quadrax, El Ochito®, power, and fiber. Modular inserts offer fast and flexible assembly and repair. Peripheral and grommet seals provide outstanding environmental protection. Keyed inserts and shells provide versatile polarization and protection against mis-mating. The innovative clamshell and banding porch design brings modern, state-of-the-art connector capabilities to modular cable and panel applications.



- For reduced size and weight cable and panel applications
- Lightweight composite shell with integral strain relief/banding porch
- Modular inserts support a wide range of contact sizes and types up to #8
- Polarization – both shell and inserts
- Center jackscrew with self-locking hardware



For more information contact Glenair at 818-247-6000 or visit our website at [www.glenair.com](http://www.glenair.com) U.S. CAGE code 06324

## SERIES 20 Super-Twin™ Lightweight Composite Modular Connectors



### SUPER-TWIN™ SHELLS AND INSERTS ARE ORDERED SEPARATELY

How To Order - Shells						
Sample Part Number	200-013	P	2	-XM	31	K
Series 20 Modular Connector	200-013 Plug Shell 200-014 Receptacle Shell					
Plug/Receptacle	P = Plug Shell, R = Receptacle Shell					
Size	Size 2					
Finish	XM = Electroless Nickel XB = No plating, black					
Polarization Code	2 digits: First digit 1 – 4 (factory installed) Second digit 1 – 4 (factory installed) Blank = keys supplied as kit					
MicroBand Option	K = MicroBand supplied. Blank = no MicroBand					

How To Order - Inserts						
Sample Part Number	200-005	P	2	-60	A	
Series 20 Modular Connector	200-005 Pin Insert 200-006 Socket Insert					
Pin/Socket Insert	P = Pin Insert, S = Socket Insert					
Size	Size 2					
Insert Pattern	60 = 60X #23 contacts					
Polarization	A, B, C, D, E, F, G, H (must match with shell polarization)					

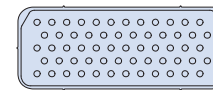

PATTERN 60  
60 X Size 23 Contacts  
DWV= 750 VAC

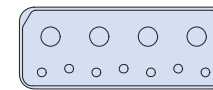

PATTERN 7W4  
4 X Size 12 Contacts  
7 X Size 20 Contacts  
DWV= 1500 VAC

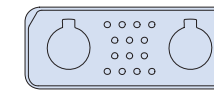

PATTERN 14Q2  
2 X Size 8 Contacts  
14 X Size 23 Contacts  
DWV= 750 VAC

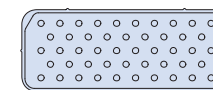

PATTERN 48  
48 X Size 23 Contacts  
DWV= 1300 VAC  
DWV@50 000 ft = 800 VAC

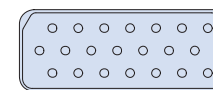

PATTERN 21  
21 X Size 20 Contacts  
DWV= 1500 VAC

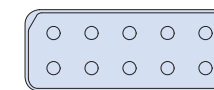

PATTERN 10  
10x Size 16 Contacts  
DWV= 1500 VAC



Modular inserts easily removed with available tool

Keyed, snap-in-place insert modules are currently available in six tooled layouts, accommodating size #23, #20, #16, #12 and keyed size #8 contacts (for use with Quadrax or El Ochito™ contacts).



### Weight Study, Typical Regional Jet Airframe

Series 20 SuperTwin™  
Mated Pair: 67g  
Weight/Plane: 7,661g

Legacy rectangular: aluminum  
Mated Pair: 192g  
Weight/Plane: 22,103g

Legacy rectangular: composite  
Mated Pair: 141g  
Weight/Plane: 16,123g

**Summary:**  
Using Series 20 composite instead of legacy aluminum connector saves **14,442 grams** (31.8 lbs) per plane.

Using Series 20 composite instead of legacy composite connector saves **8,482 grams** (18.6 lbs) per plane

### Series 20 Super-Twin™ Performance

DWV	1500 Vac; 750 VAC (#23 contacts)
Shell-to-Shell	2.5 mΩ
Temp Range	-65°C / +125 °C
Shock*	50 g, half sine, 18x
Vibration*	Random, 8 hrs/axis, Type VI, cond. G (27.8 g)
Altitude Immersion*	12.1 kPa (15000 m / 49000 ft)
Lightning Indirect Effects	3 kA min

\*Test by similarity, Series 79 Micro-Crimp





# SERIES 28 HiPer-D Connectors

## High-performance M24308 intermateable

The HiPer-D connector is a M24308-type D-Subminiature connector with superior design features. Unlike standard M24308 connectors with stamped steel shells, the HiPer-D connector features a one-piece machined shell, and is rated for 200°C continuous operating temperature. Aerospace grade fluorosilicone grommets and face seals provide environmental protection. The HiPer-D is intermateable, intermountable and interchangeable with standard M24308 D-Sub connectors. A ground spring offers enhanced EMI/RFI protection. New Combo-D insert arrangements for Coax, QuadraX, fiber and El Ochito® contacts now available.

- Advanced temperature, vibration and EMC/ electrical performance
- 11 standard and 20 combo insert arrangements
- High temperature epoxy insulators
- Watertight sealing
- Rugged machined one-piece shell

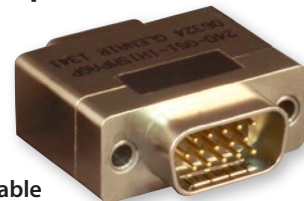

Available EMI/EMP filters

## SERIES 28 M24308 INTERMATEABLE HiPer-D® Connectors



### COMBO-D CONTACT ARRANGEMENTS (face view of pin connector)

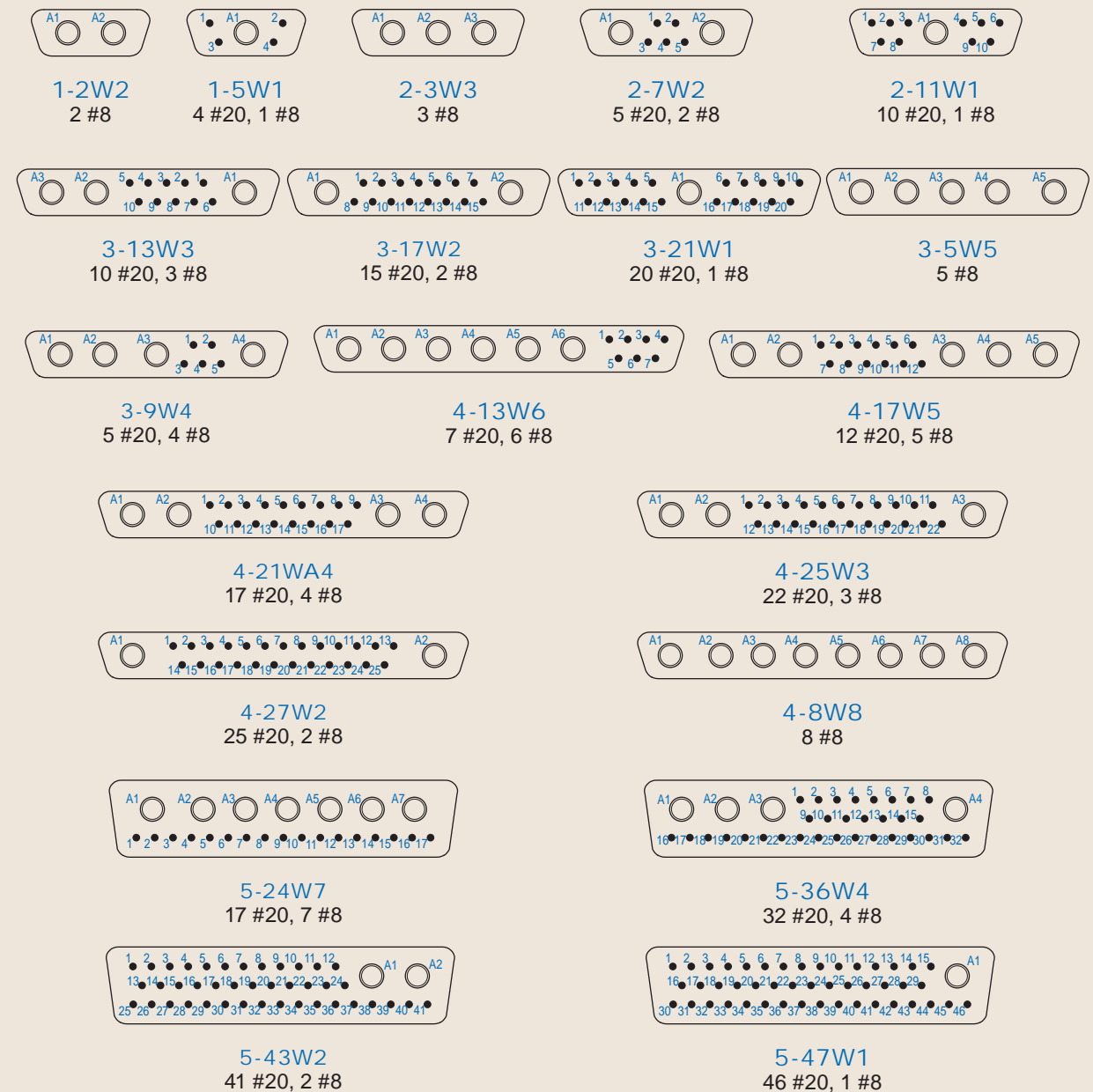

### STANDARD AND HIGH DENSITY CONTACT ARRANGEMENTS (face view of pin connector)

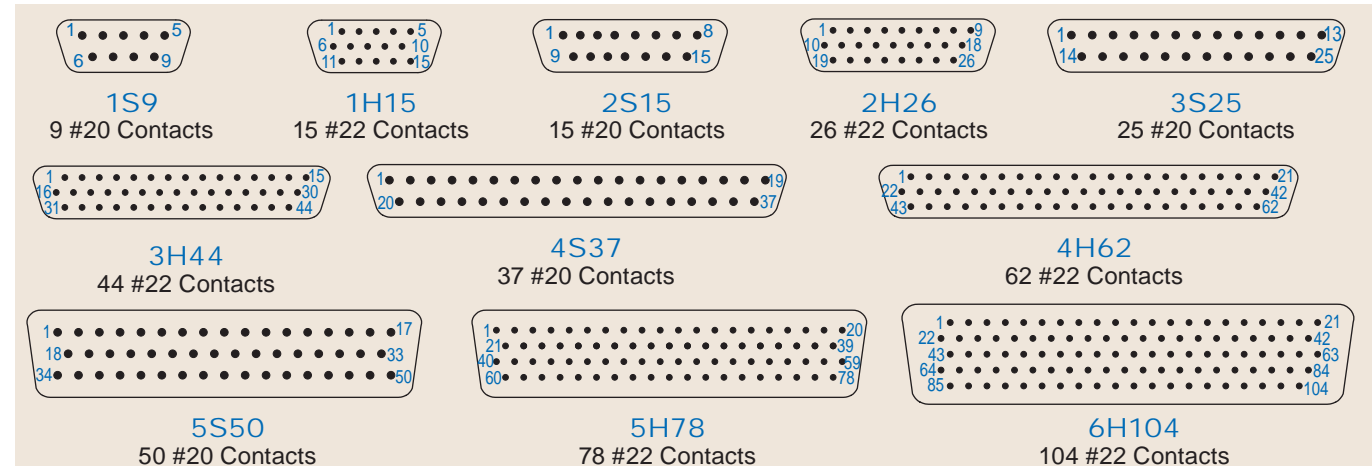





# SERIES 240 ARINC 600 Filter Connectors



Glenair manufactures a full range of ARINC 600 filter connectors for use in EMC/EMP management of electronic systems and interconnect cabling. All connectors are designed in accordance with the ARINC 600 specification, and are designed to mate with ARINC 600 plugs with the same insert configuration and opposite contact gender. Planar filter arrays and TVS diodes may be integrated into both standard catalog as well as build-to-order configurations. Glenair's state-of-the-art diode burn-in process tests leaded and surface mount diodes with leakage current monitored throughout the entire test procedure ensuring field reliability.

Capacitor Array Code / Capacitance Range		
Class	Pi - Circuit (pF)	C - Circuit (pF)
X	160,000 - 240,000	80,000 - 120,000
Y	80,000 - 120,000	40,000 - 60,000
Z	60,000 - 90,000	30,000 - 45,000
A	38,000 - 56,000	19,000 - 28,000
B	32,000 - 45,000	16,000 - 22,500
C	18,000 - 33,000	9,000 - 16,500
D	8,000 - 12,000	4,000 - 6,000
E	3,300 - 5,000	1,650 - 2,500
F	800 - 1,300	400 - 650
G	400 - 600	200 - 300
J	70-120	35-60



ARINC 600 size 2 filter connector. Glenair also manufactures narrow-profile size 1 and double-wide size 3. All configurations are environmentally sealed for rugged airframe applications.

- Planar, multilayer ceramic capacitive filters, with and without transient voltage suppression diodes
- C and Pi electrical configurations
- PC tail or solder cup wire termination
- 36 – 240,000 pF capacitance
- Insert arrangements IAW ARINC 600
- Fast and reliable diode burn-in and test services
- Turnkey in-house manufacturing of all filter connector elements and processes

## SERIES 240 ARINC 600 Filter connectors Fast, reliable in-house manufacturing

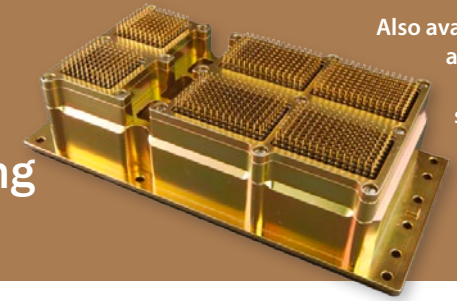

Also available: ARINC 404 and build-to-order ARINC filter solutions. Consult factory for more information

### ARINC 600 SIZE 2 AND 3 INSERT ARRANGEMENTS

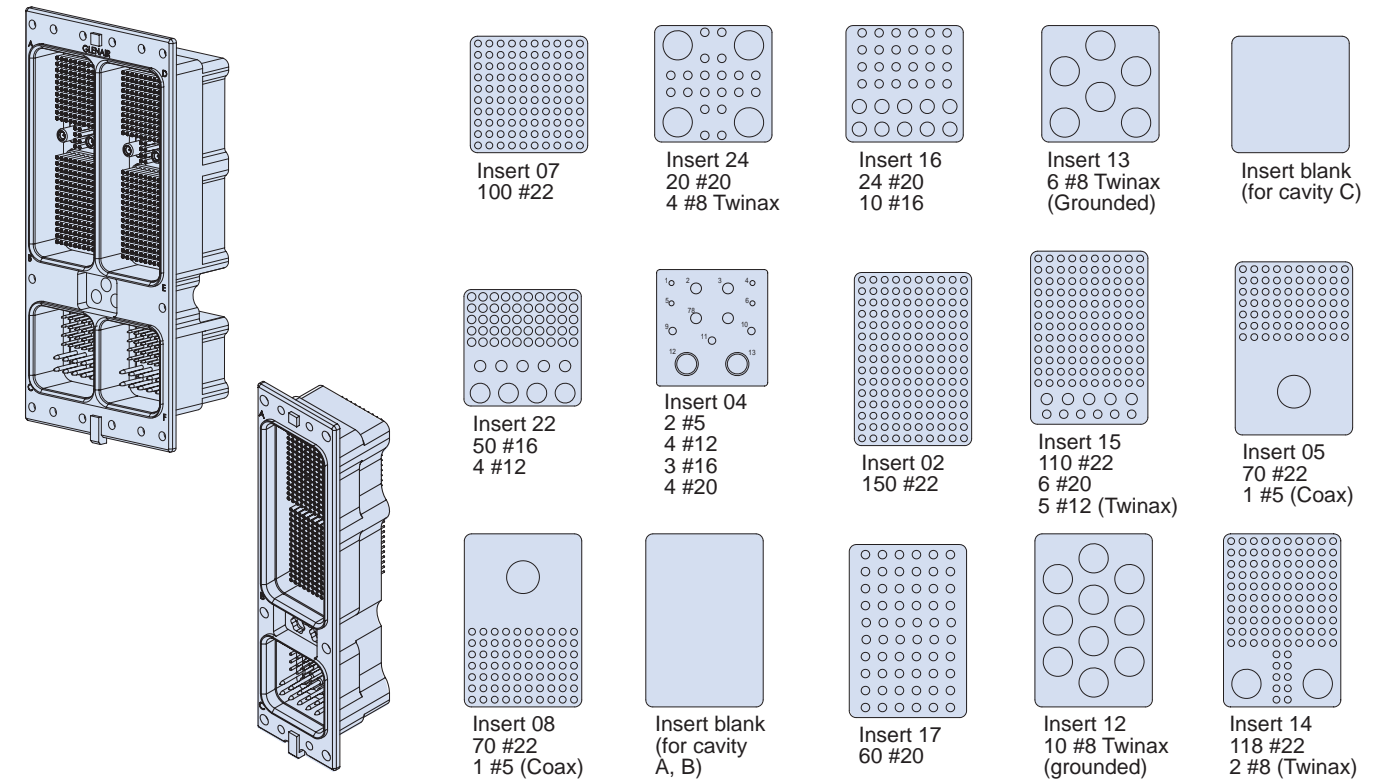

### ARINC 600 SIZE 1 INSERT ARRANGEMENTS

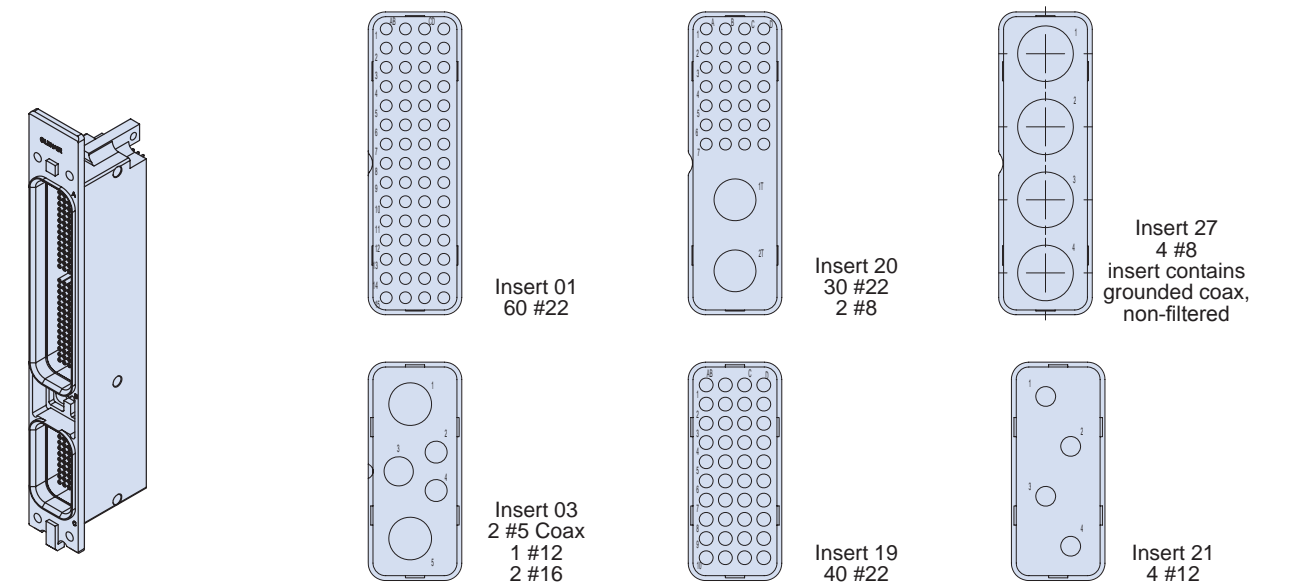



# Fiber Optic and Opto-Electronic Interconnect Solutions

For land, sea, air, space, and C4ISR applications

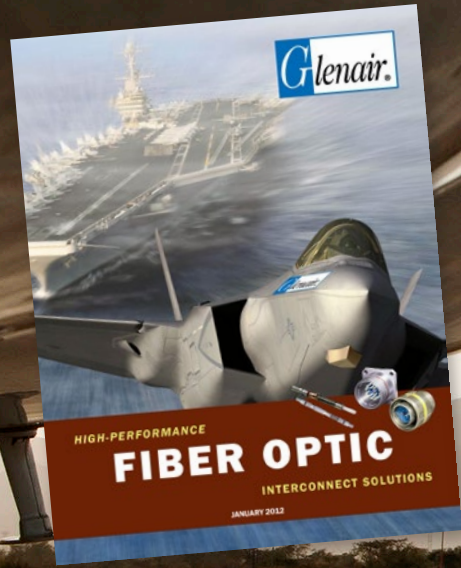

Glenair Fiber Optic and Opto-Electronic interconnect technologies deliver high data rate and bandwidth, reduced size and weight, EMI immunity, enhanced security, and spark/arc immunity. Our broad offering of fiber optic systems includes qualified MIL-PRF-28876 connectors and termini for shipboard applications, MIL-DTL-38999 Series III type fiber optic connectors and termini for aerospace applications, as well as our revolutionary Eye-Beam™ Expanded Beam termini. Small form-factor Opto-Electronic solutions are offered for harsh-environment Ethernet, video, high-speed data, and signal aggregation.

## Fiber Optic Interconnect Systems



MIL-DTL-38999 Type Fiber Optic



GHD High Density Fiber Optic



Series 80 Mighty Mouse Fiber Optic

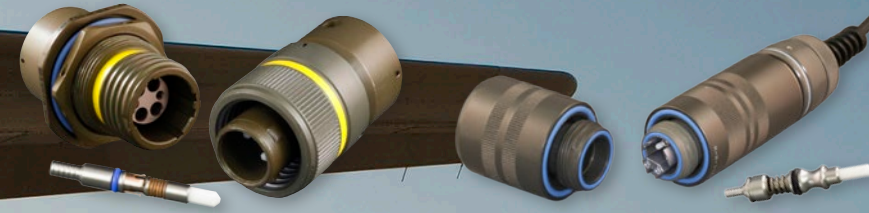

MIL-PRF-28876 Fiber Optic

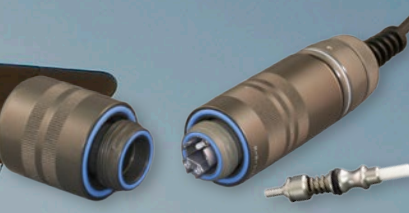

GFOCA M83526 Compliant Fiber Optic

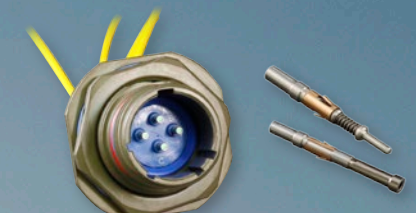

Eye-Beam™ Expanded Beam Fiber Optic

## Opto-Electronic Interconnect Solutions



Size 8 Cavity Opto-Electronic Contacts

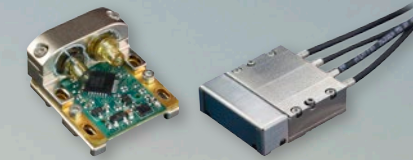

PCB-Mount Opto-Electronic Transceivers

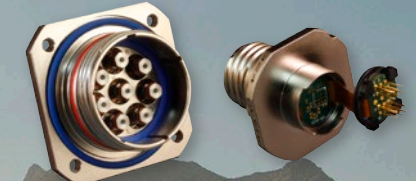

Harsh-Environment Opto-Electronic Connectors



Copper-to-Fiber Media Converters

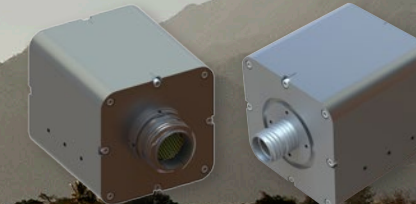

Signal Aggregation Media Converters



Ethernet Switches



**Now Available:**  
Glenair Series 185-002 Hi-Beam™  
MIL-DTL-83526/20 and /21 compliant  
and intermateable hermaphroditic  
expanded beam connectors



For more information  
contact Glenair at  
**818-247-6000** or  
visit our website at  
**www.glenair.com**  
U.S. CAGE code 06324





TIGHT-TOLERANCE

# MIL-DTL-38999 Series III Type

## Fiber optic connection system

The high performance fiber optic interconnect system successfully deployed in hundreds of commercial and military aerospace and other applications—from F-16 upgrade systems to the revolutionary F-35 Joint Strike Fighter

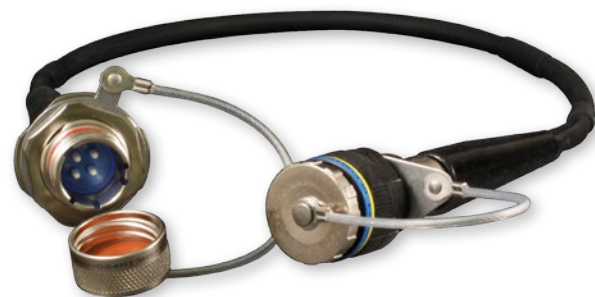

Terminated and tested point-to-point and multibranch D38999 type fiber optic cable assemblies

MIL-DTL-38999 Series III type plug and square flange wall-mount receptacle



- MIL-DTL-38999 type tight tolerance fiber optic connectors
- Composite, aluminum and stainless steel shells available
- Qualified size #16 MIL-PRF-29504 precision ceramic termini
- Singlemode and multimode fiber, from 9/125 to 1000 microns
- Ultra-low insertion loss values, <.50dB typical
- From 2 to 37 Termini
- Plug and In-Line, Jam Nut and Square Flange Receptacles
- Patented MIL-DTL-38999 fiber optic test probes and adapters

# TIGHT-TOLERANCE MIL-DTL-38999 Series III Type

## Advanced fiber optic connection system



MIL-DTL-38999 type fiber optic connection system termination, inspection, test, and cleaning tools are available now from Glenair. We also offer comprehensive F/O training services for assembly and maintenance technicians.

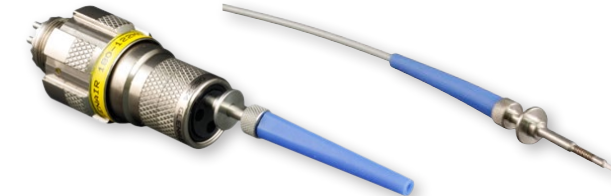

Glenair optical fiber test probes and connector adapters provide accurate and repeatable testing of MIL-DTL-38999 F/O assemblies

Glenair M29504/4 and /5 QPL termini are in stock and ready for immediate, same-day shipment



A complete range of metal and composite backshells and protective covers is available

MIL-PRF-29504/04 and /05 Fiber Optic Termini Performance Data	
Test Type	Performance Requirement
Operating Temperature	-55°C to +165°C (dependent on epoxy and cable)
Temperature Cycling	-65°C to +175°C
Thermal Shock	-55°C to +150°C, 5 cycles
Temperature Life	+150°C for 1,000 hours
Random Vibration	20-2,000 Hz, 42.2 g's
Shock (Half-sine Pulse)	300 g Peak Load
Mechanical Shock	MIL-S-901, Grade A, Type B, Class I
Mating Durability	500 cycles (cleaning after 100 matings)
Salt Spray	48 hours (Terminus only)
Cable Retention Force	22.0 lbs (dependent on cable construction)

D38999 Type Fiber Optic Connector Part Numbers	
Glenair Dwg. Number*	Product Description
181-001	#16 Socket Terminus
181-002	#16 Pin Terminus
181-048	#16 Dummy Terminus
180-091 (05)	In-Line Receptacle Connector
180-091 (06)	Plug Connector
180-091 (08)	Jam Nut Mount Receptacle Connector
180-091 (H7)	Square Flange Wall Mount Receptacle with Round Holes
180-091 (S7)	Square Flange Wall Mount Receptacle with Slotted Holes
180-091 (T7)	Square Flange Wall Mount Receptacle with Tapped Holes

\* See fiber optic catalog for complete part number information

### INSERT ARRANGEMENTS

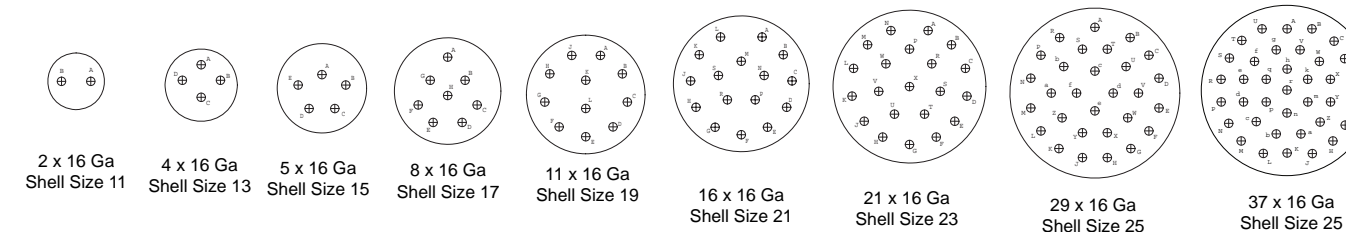

Per MIL-STD-1560. Mating face of pin insert shown.







SIZE AND WEIGHT-SAVING

# Glenair High-Density (GHD) Fiber optic connection system

The system of choice for military and commercial air, space and other applications: Outstanding optical and environmental performance with nearly double the density of standard mil-spec designs



GHD plug connector with alignment sleeve retainer, and square flange receptacle. Termini available in keyed and non-keyed styles

- Innovative #18 (1.25mm ferrule) front-release genderless termini accommodate 900µ to 2.0mm jacketed fiber
- M85045/16 cable accommodation
- Composite, aluminum and stainless steel shells available
- Single keying for APC polish available
- Better optical performance than D38999 with nearly double the density
- Precision alignment sleeve retainer with integrated guide pins
- Piston o-ring sealing—submersible design

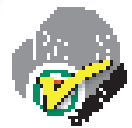

## SIZE- AND WEIGHT-SAVING Glenair High Density (GHD) Fiber optic connection system

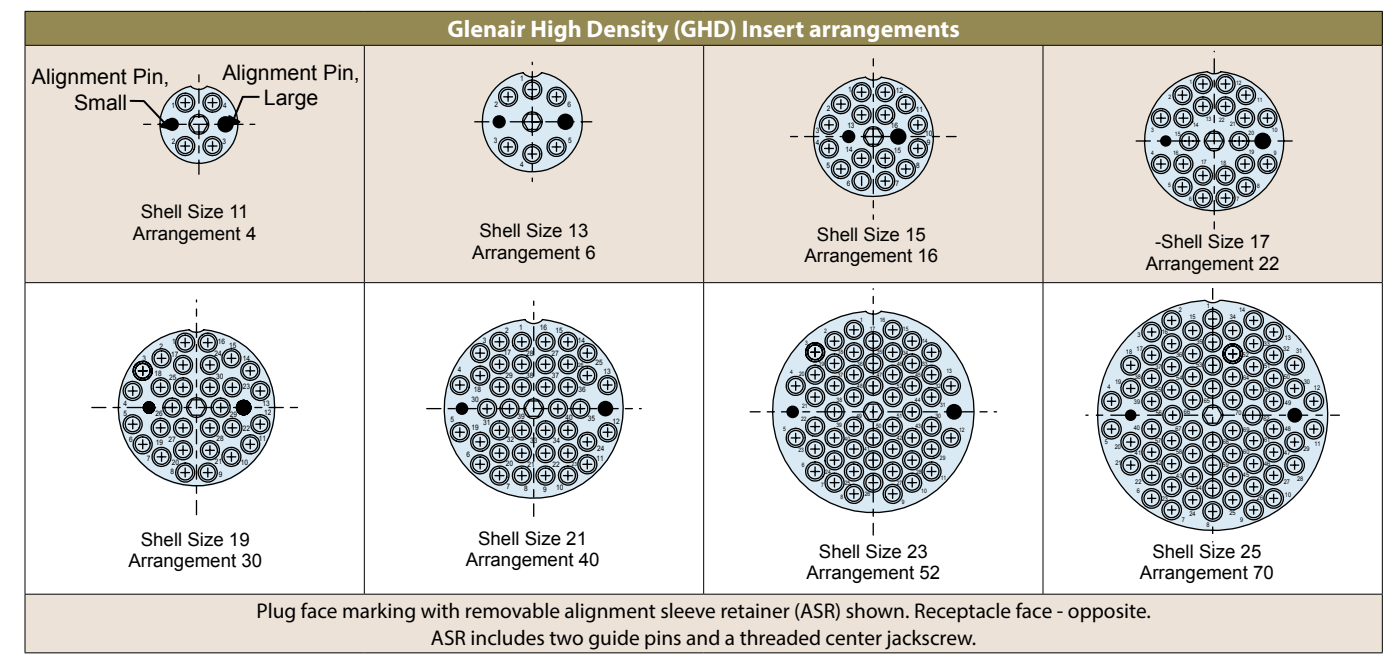

Fiber Optic Pin Termini Specifications			
Assembly Dash Number		Fiber Size	A Dia.
Keyed	Non-Keyed	Core/Cladding	[microns]
181-047-1255C	181-056-1255C	9/125 (Singlemode)	125.5
181-047-1260C	181-056-1260C	9/125, 50/125, 62.5/125	126.0
181-047-1270C	181-056-1270C	50/125, 62.5/125	127.0
181-047-1420C	181-056-1420C	100/140	142.0
181-047-1450C	181-056-1450C	100/140	145.0
181-047-1560C	181-056-1560C	62.5/125/155 (Polyimide)	156.0
181-047-1570C	181-056-1570C	62.5/125/155 (Polyimide)	157.0
181-047-1730C	181-056-1730C	100/140/172 (Polyimide)	173.0
181-047-1750C	181-056-1750C	100/140/172 (Polyimide)	175.0
181-047-2360C	181-056-2360C	200/233	236.0
181-047-2860C	181-056-2860C	200/280	286.0

Crimp Sleeve is supplied with Terminus Assembly, and may be ordered separately. For terminus less crimp sleeve, omit C from end of part number (e.g. 181-056-1260)

GHD Fiber Optic Part Number Reference	
Glenair Dwg. Number	Product Description
181-047	#18 Pin Terminus, Keyed for APC Polish
181-056	#18 Pin Terminus (non-keyed)
181-058	#18 Dummy Terminus
180-122 (05)	In-Line Receptacle Connector
180-122 (06)	Plug Connector with Alignment Sleeve Retainer
180-122 (08)	Jam Nut Mount Receptacle Connector
180-122 (H7)	Square Flange Receptacle with Round Holes
180-122 (S7)	Square Flange Receptacle with Slotted Holes

\* See fiber optic catalog for complete part number information

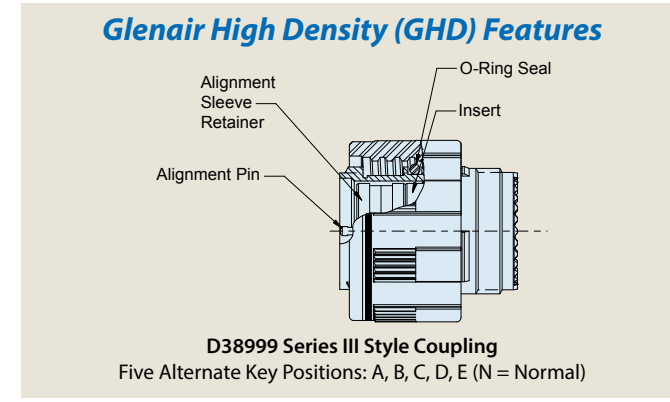

Pin Density Comparison: Glenair High Density Versus D38999 and M28876								
Connector Style / Size	11	13	15	17	19	21	23	25
D38999 Cavity Count	2	4	5	8	11	16	21	29/37
M28876 Cavity Count	2	4	8	N/A	N/A	N/A	31	N/A
GHD Cavity Count	4	6	16	20	30	40	52	70



F



ULTRAMINIATURE  
Series 80 Mighty Mouse  
Fiber optic connection system



ULTRAMINIATURE  
Series 80 Mighty Mouse  
Fiber optic connection system



Series 801 Plug  
with 181-057 pin termini

Series 801 receptacle  
with 181-075 socket termini

- Three snap-in, rear release fiber optic termini sizes: #23, #20HD, and #16 for use in any Series 80 Mighty Mouse connector
- The smallest mil-aero caliber fiber optic connection system available
- Singlemode and multimode
- Precision ceramic ferrules
- <0.5 dB typical attenuation
- 1 to 130 channels



The perfect marriage of high bandwidth fiber optics with ultra-miniature packaging—half the size of D38999

SIZE #16 FIBER OPTIC TERMINI



Termini Type	Optical Fiber Type	Part Number	A Ferrule I.D.	Fiber Size Core/Cladding
Pin	Multi Mode	181-057-126	126.0 microns	50/125, 62.5/125
	Single Mode	181-057-125	125.5 microns	9/125
Socket	Multi Mode	181-075-126	126.0 microns	50/125, 62.5/125
	Single Mode	181-075-125	125.5 microns	9/125

\*Consult factory for additional sizes

Series 801 9-4 with size #16 fiber optic termini vs. equivalent functionality D38999



Series 801  
Shell size 9, 4 channel  
6 Grams (less termini)

D38999 Series III  
Shell size 13, 4 channel  
27 Grams (less termini)

SIZE #20HD FIBER OPTIC TERMINI



Termini Type	Optical Fiber Type	Part Number	A Ferrule I.D.*	Fiber Size Core/Cladding
Pin	Multi Mode	181-084-126	126.0 microns	50/125, 62.5/125
	Single Mode	181-084-1255	125.5 microns	9/125
Socket	Multi Mode	181-085-126	126.0 microns	50/125, 62.5/125
	Single Mode	181-085-1255	125.5 microns	9/125

\*Consult factory for additional sizes

Series 801 8-8 with size #20 HD fiber optic termini vs. equivalent functionality D38999



Series 801  
Shell size 8, 8 channel  
8 Grams (less termini)

D38999 Series III  
Shell size 17, 8 channel  
40 Grams (less termini)

SIZE #23 FIBER OPTIC TERMINI



Termini Type	Optical Fiber Type	Part Number	A Ferrule I.D.	Fiber Size Core/Cladding*
Pin	Multi Mode	181-063-126	126.0 microns	50/125, 62.5/125
	Single Mode	181-063-1255	125.5 microns	9/125
Socket	Multi Mode	181-064-126	126.0 microns	50/125, 62.5/125
	Single Mode	181-064-1255	125.5 microns	9/125

\*Consult factory for additional sizes

Series 801 6-4 with size #23 fiber optic termini vs. equivalent functionality D38999



Series 801  
Shell size 6, 4 channel  
5 Grams (less termini)

D38999 Series III  
Shell size 13, 4 channel  
21 Grams (less termini)

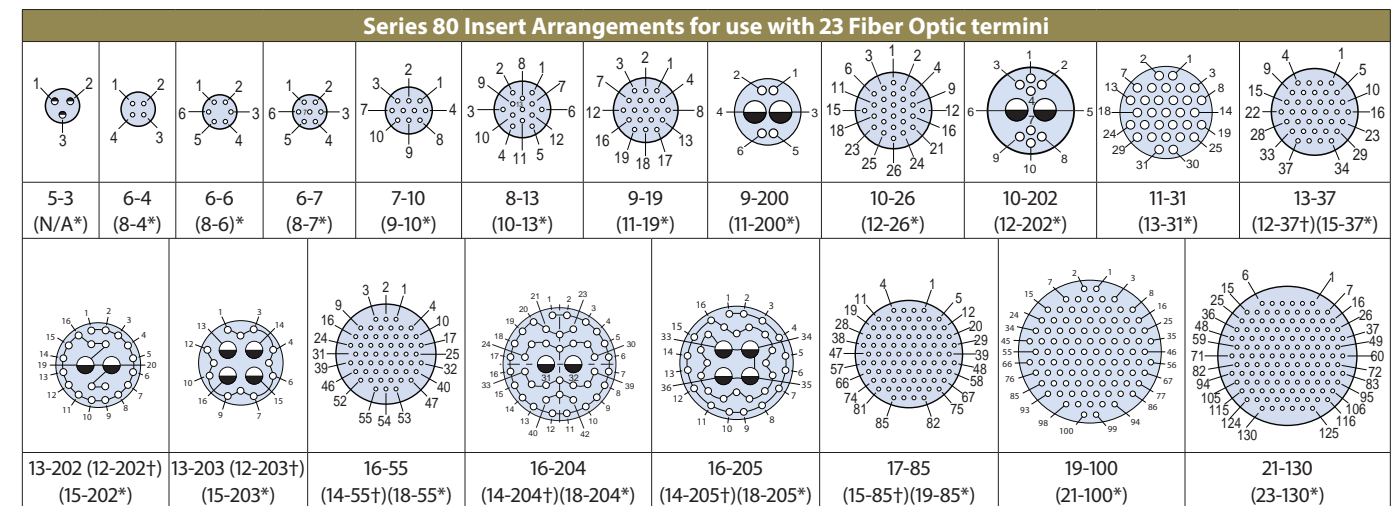
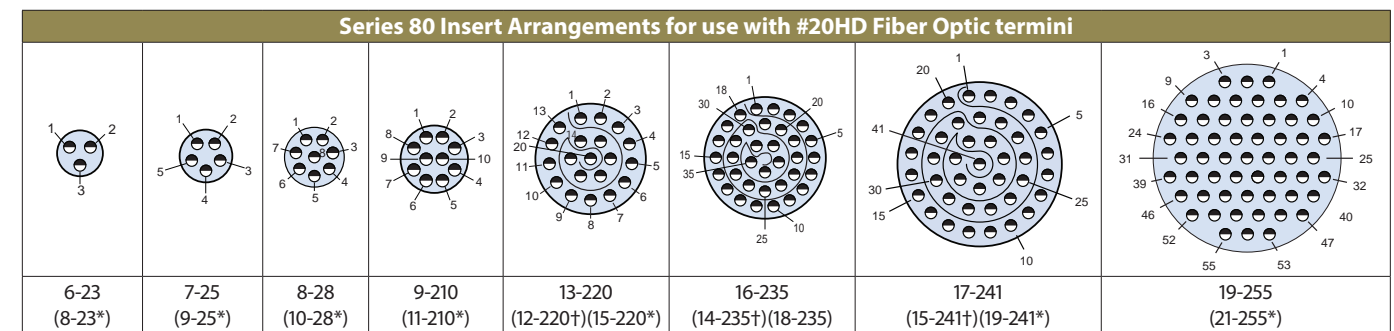
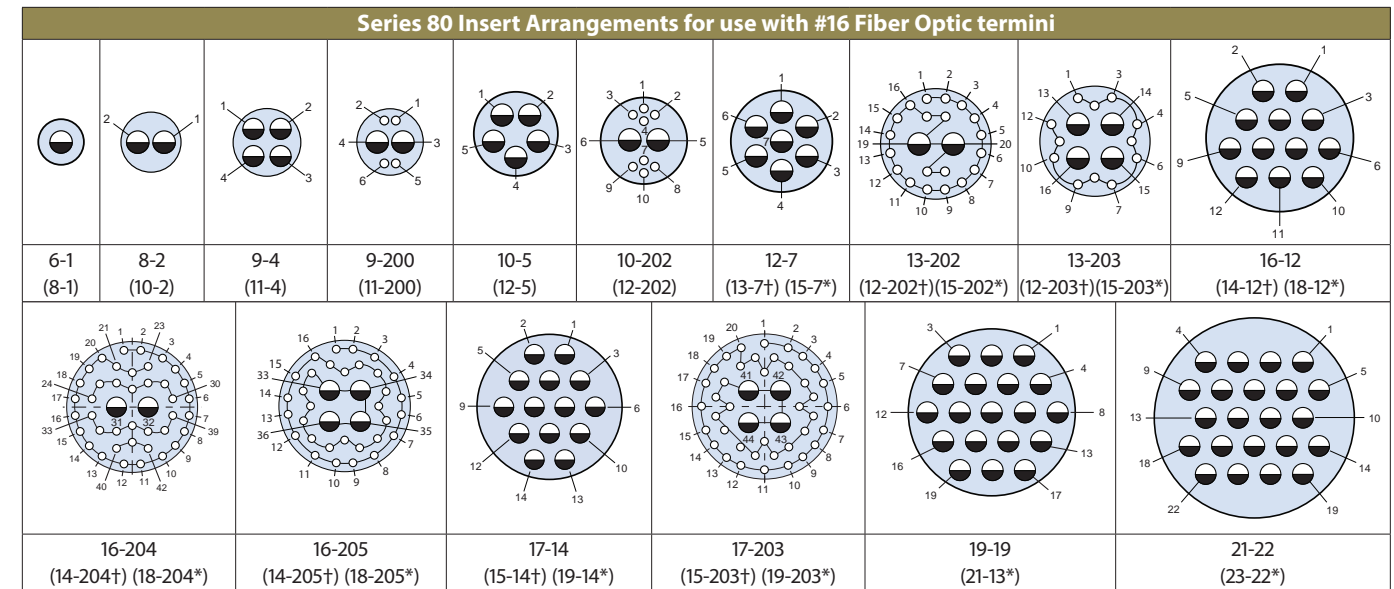

Series 801/802 designator (\*Series 805 designator) (†Series 802 designator)

See Series 80 Mighty Mouse catalog for connector ordering information. Order connectors less contacts and order fiber optic termini separately. Cavity numbers are mating face view of pin connectors.





# QPL AND COMMERCIAL MIL-PRF-28876

## Fiber optic connection system



# QPL AND COMMERCIAL MIL-PRF-28876

## Fiber optic connection system

Qualified MIL-PRF-28876 fiber optic connectors and MIL-PRF-29504 termini—Navy approved, in stock, and ready for immediate shipment



- Connectors qualified to the complete requirements of MIL-PRF-28876 including plugs, wall-mount receptacles, jam-nut mount receptacles and in-line receptacles
- Multiple shell sizes and insert arrangements, including 2, 4, 6, 8, 18 and 31 channel layouts
- Backshells in straight, 45° and 90° configurations
- Corrosion-resistant and environmentally sealed
- Qualified MIL-PRF-29504/14 and /15 pin and socket termini and /3 dummy terminus
- Connectors, backshells and protective covers available for immediate, same-day shipment

Connector/Backshell Types			
Connector Type	Backshell Type	MIL-Spec	Commercial Connector Type Code
Wall Mount Receptacle	None	M28876/1	03
	Straight	M28876/2	13
	45°	M28876/3	23
	90°	M28876/4	33
In-Line Receptacle	Straight	M28876/5	15
Plug	None	M28876/6	06
	Straight	M28876/7	16
	45°	M28876/8	26
	90°	M28876/9	36
Jam Nut Receptacle	None	M28876/11	04
	Straight	M28876/12	14
	45°	M28876/13	24
	90°	M28876/14	34



Qualified Fiber Optic Termini			
Type	Military Part Number	A Dia (Microns)	Typical Fiber Type
Pin Termini	M29504/14-4131C	126.0	Multi Mode
	M29504/14-4132C	127.0	Multi Mode
	M29504/14-4135C	142.0	Multi Mode
Socket Termini	M29504/15-4171C	126.0	Multi Mode
	M29504/15-4172C	127.0	Multi Mode
	M29504/15-4175C	142.0	Multi Mode
Dummy Terminus	M29504/3-4038		

Crimp sleeve is supplied with terminus assembly and may be ordered separately (see Table II). For terminus less crimp sleeve, omit C from end of part number. Consult factory for additional sizes.

Terminated and tested MIL-PRF-28876 fiber optic cable assembly



Test Description	Performance Requirements/ Specifications
Optical Insertion Loss, Multimode	-0.3 dB Typical (62.5/125)
Optical Insertion Loss, Singlemode	-0.3 dB Typical (9/125)
Optical Back Reflection, Singlemode	Better than -40 dB - PC Polish • Better than -50 dB - Enhanced PC Polish
Operating Temperature	-28°C to +65°C (MIL-Spec Epoxy and Cable) -55°C to +125°C (alternative Epoxy and Cable)
Temperature (Thermal) Shock	-40°C to +70°C, 5 Cycles
Temperature Cycling	-28°C to +65°C, 5 Cycles
Temperature/Humidity Cycling	-10°C to +65°C, 10 Cycles, 240 hours, 98% RH
Temperature Life Aging	+110°C, 240 hours, Dry Air
Mating Durability	500 cycles
Vibration - Sinusoidal	10 g Peak, 5-500 Hz sin./ 10.2 g RMS, 50-2000 Hz random
Impact	8 Drops from 8 feet
Crush Resistance	281 lbs, 7 Cycles
Cable Pull Out Force - Termini	Termini: 22 lbs min for 1 minute Connector: 162 lbs min for 10 minutes
Fluid Immersion	Turbine Fuel, Isopropyl Alcohol, Hydraulic Fluid, Lubricating Oil, Coolant, Tap- and seawater, 24 hrs
Water Pressure	32 feet for 48 hours at +10°C to +35°C
Mechanical Shock (High Impact)	MIL-S-901, Grade A, Type B, Class I
Corrosion Resistance (Salt Spray)	500 hours
Sand and Dust	12 hours
Flammability	0.75 inch flame for 10 sec. mated, 1.50 inch flame for 60 sec. unmated

\*Performance Specifications/Requirements based on the use of MIL-PRF-24792 Epoxy and MIL-PRF-85045 Simplex and Breakout Shipboard Optical Fiber.

### Insert Arrangements

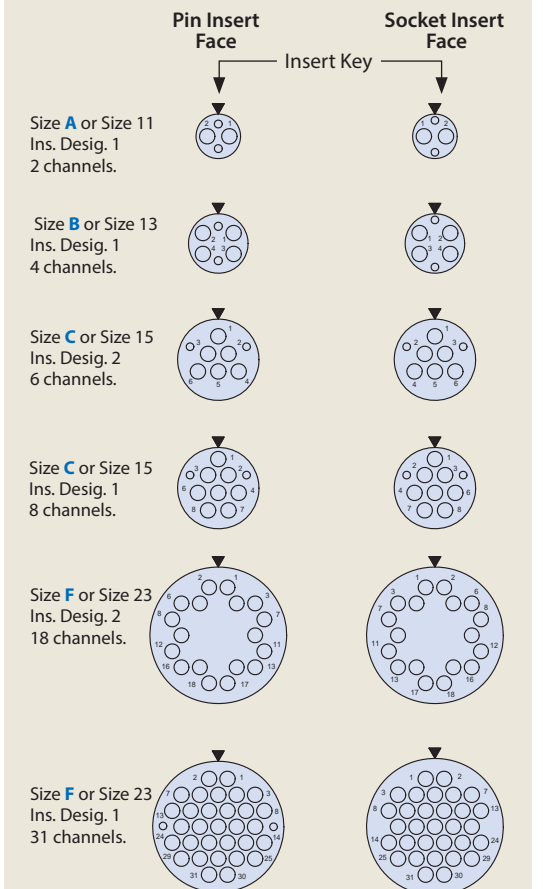





M83526 COMPLIANT  
GFOCA



Fiber optic connection system



# M83526 COMPLIANT GFOCA

## Fiber optic connection system

GFOCA: the genderless, ruggedized, environmentally-sealed solution ideal for fiber optic battlefield communications—TFOCA-II® intermateable!

- 4 channel singlemode and multimode configurations
- Designed IAW MIL-PRF-29504/16 and MIL-DTL-83526/16 and /17 drafts
- Discrete components or complete cable-on-reel solutions available
- Rugged field deployable system
- Corrosion resistant and environmentally sealed
- Low insertion loss 2.5mm diameter genderless butt joint termini
- Designed for both low speed analog and high-speed digital data



Turnkey point-to-point and pigtail GFOCA cable assembly

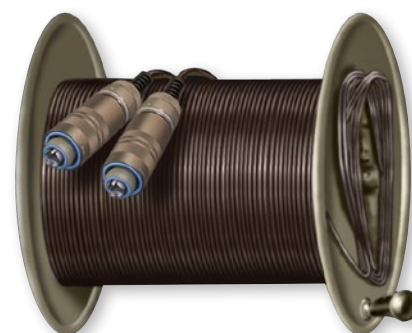

Factory Terminated Fiber Optic Cable Spool

### GFOCA COMPONENTS AND CABLE-ON-REEL SOLUTIONS



GFOCA jam nut mount receptacle connector with lanyard-attached dust cover

Hermaphroditic Cable Plug Connector

Genderless Butt-Joint Terminus

GFOCA Performance Specifications	
Insertion Loss	<.50 dB Typical
Cable Pull Resistance	400 pounds minimum, 1 hour; applies to plug and strain relief receptacles
Mating Durability	2000 Cycles
Operating Temperature	-46° C to +71° C
Storage Temperature	-55° C to +85° C
Cable Diameter Accommodation	.190" Minimum to .379" Maximum



Glenair GFOCA M83526 Compliant fiber optic connection system termination, inspection, test, and cleaning tools are available now from Glenair. We also offer comprehensive F/O training services for assembly and maintenance technicians.

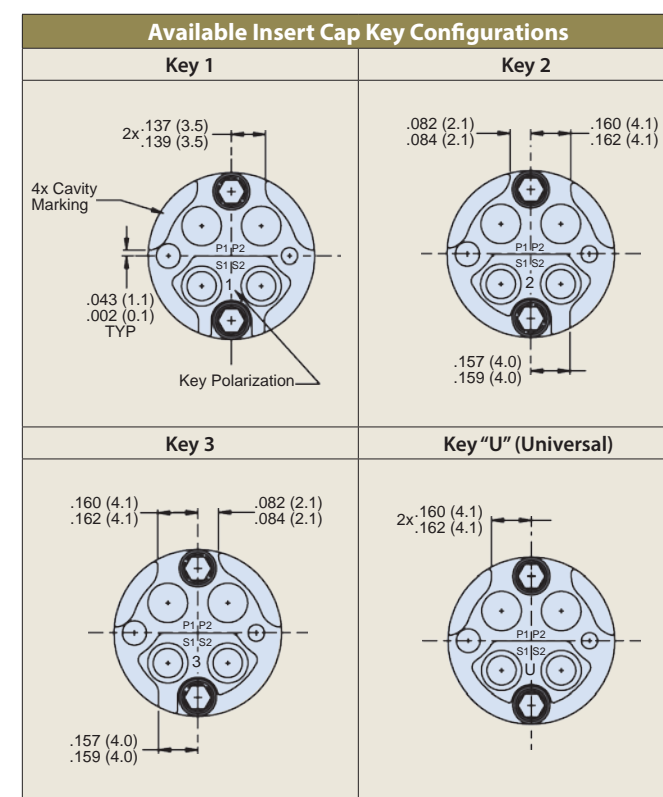

GFOCA Part Number Reference	
Drawing Number	Product Description
181-050	Pin Terminus
180-050-S	Alignment Sleeve, Split, Ceramic
181-059	Dummy Terminus
180-145	Plug Connector, Hermaphroditic, 4 Channel
180-146	Jam Nut Receptacle, 4 Channel
180-147	Square Flange Receptacle, 4 Channel
180-148	Jam Nut Receptacle, 4 Ch, Internal Mount
180-149	Jam Nut Receptacle, 4 Channel, Internal Mount with Accessory Threads
180-150	Jam Nut Receptacle, 4 Channel, Panel Mount with Accessory Threads
180-153	Jam Nut Receptacle, 4 Channel, Internal Mount with Strain Relief
180-137	Plug Connector, Hermaphroditic, 90°, 4 Channel

GFOCA Genderless Termini Part Numbers		
Dash Number	Ø A (Microns)	Fiber Type (Typ)
181-050-1255C	125.5	SM
181-050-1260C	126.0	SM and MM

SM: Singlemode MM: Multimode  
Consult Factory for Additional Sizes

TFOCA-II® is a registered trademark of Amphenol Fiber Systems International

F





EXPANDED-BEAM

Eye-Beam™

Fiber optic connection system

Innovative expanded beam termini and factory-terminated jumpers deliver optimal performance in harsh environments

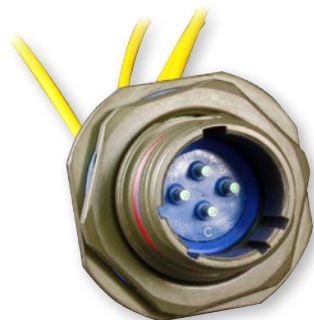

Eye-Beam™ Expanded Beam fiber optic terminus integrated into a tight-tolerance D38999 Series III type jam-nut receptacle connector

Factory terminated GRIN lens pin termini and GRIN lens socket termini on pigtail fibers allow for easy fusion splicing in the field.

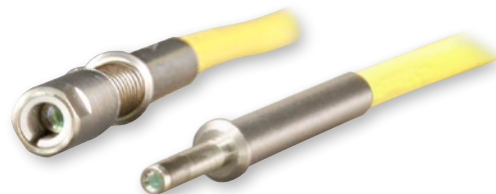

- All the benefits of an expanded beam connection system built into a discrete, removable F/O terminus
- Factory-terminated F/O Eye-Beam™ termini easily integrated into any connector package
- Innovative expanded beam GRIN lens terminus expands signal 27X from a standard 9.3 micron fiber core
- Revolutionary design delivers low dB loss (1.5 dB multimode, 2.0 dB singlemode) performance while reducing maintenance, inspection and test costs
- Ultra-high precision ceramic sleeves and custom designed terminus bodies ensure perfect axial alignment

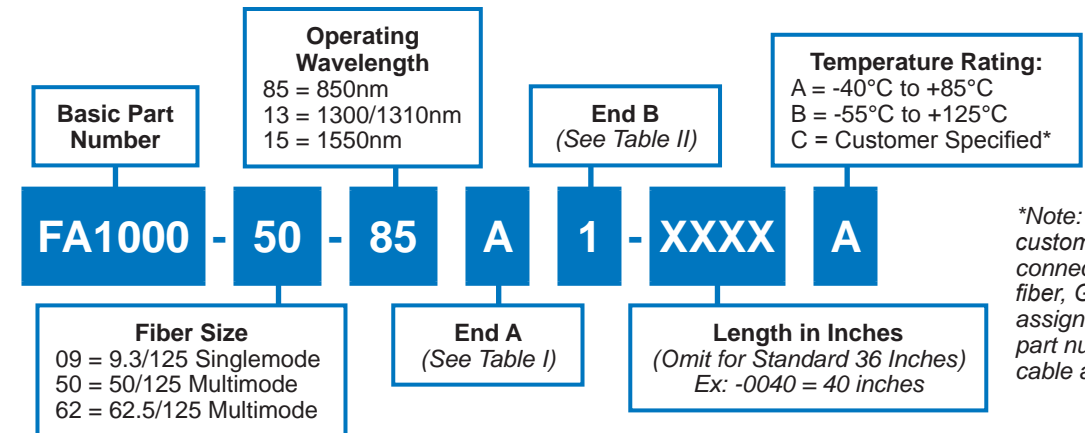

\*Note: For customer specific connectors and fiber, Glenair will assign a unique part number for the cable assembly.

Designator	Description	Connector Series
A	M29504/04 Style Pin (181-070)	MIL-DTL-38999 Series III
	Mighty Mouse Size 16 Pin (181-070)	Series 80 Mighty Mouse
B	M29504/05 Style Socket, Springless (181-077)	MIL-DTL-38999 Series III
C	M29504/14 Style Pin (181-095)	MIL-PRF-28876
D	M29504/15 Style Socket (181-096)	MIL-PRF-28876
F	Mighty Mouse Size 16 Socket (181-083)	Series 80 Mighty Mouse
G	GFR Pin (181-082)	Glenair GFR System
H	GFR Socket (181-081)	Glenair GFR System
J	GFOCA Termini (181-067)	GFOCA (hermaphroditic)

A	M29504/04 Style Pin (181-070)
	Mighty Mouse Size 16 Pin (181-070)
B	M29504/05 Style Socket, Springless (181-077)
C	M29504/14 Style Pin (181-095)
D	M29504/15 Style Socket (181-096)
F	Mighty Mouse Size 16 Socket (181-083)
G	GFR Pin (181-082)
H	GFR Socket (181-081)
J	GFOCA Termini (181-067)
1	LC Connector
2	LC APC Connector
3	FC Connector
4	FC APC Connector
5	ST Connector
6	SC Connector
7	SMA 905 Connector
8	SMA 906 Connector
9	Customer Specified*



Eye-Beam termini and factory-terminated jumpers may be integrated into a broad range of circular and rectangular connector packaging

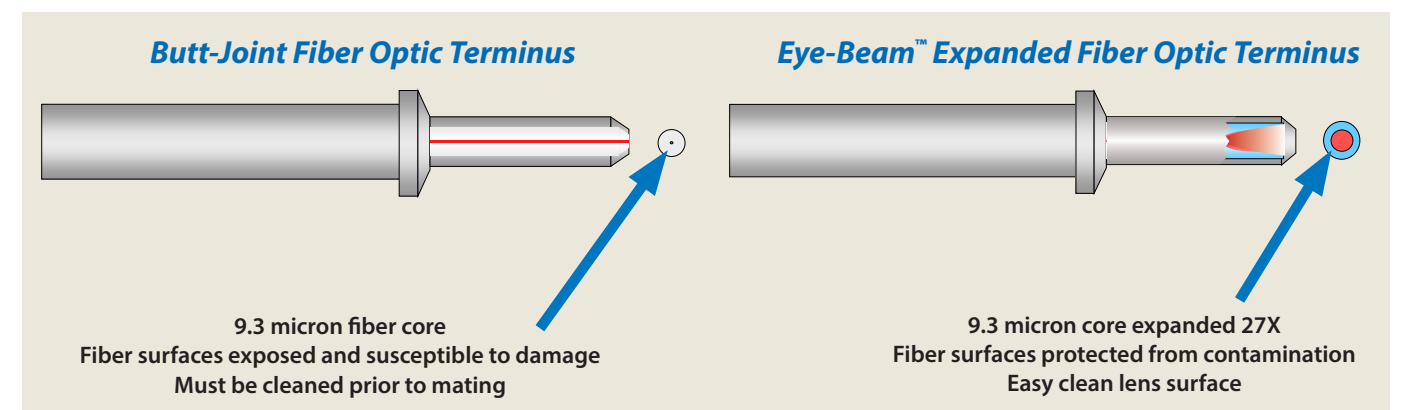





## SERIES 185-002 HI-BEAM™

# Industry standard ball lens expanded beam solution

## In accordance with MIL-DTL-83526 /20 and /21 hermaphroditic

Commercial and military customers, such as those engaged in geo-physical exploration, mass-transit and tactical warfare now depend on optical interconnect technology due to its many advantages over electrical transmission systems. Sealed expanded beam interconnect technology prevents water, mud, dust, oil and other chemicals from contaminating the optical path and deteriorating system performance. Connector housings are available in a variety of material and finish choices, including cadmium-free and RoHS-compliant options. Boots, grips, and seals are available in a range of materials as well.



- Ball lens expanded beam IAW MIL-DTL-83526 /20 and /21
- Beam expansion dramatically reduces loss due to contamination
- Large ball lens facilitates easy cleaning
- Fully intermateable with all MIL-DTL-83526 /20 and /21 compliant connectors
- 2 and 4-channel insert arrangements
- Expanded beam lens insert also available in D38999 type packaging

SERIES 185-002 HI-BEAM™

MIL-DTL-83526 /20 & /21 compliant and intermateable hermaphroditic expanded beam connectors



### SERIES 185-002 HI-BEAM™ CONNECTORS AND CABLES



M83526/20 type  
Hermaphroditic Cable Plug Configuration

M83526/21 type  
Panel-Mount Configuration

The Glenair 185-002 Hi-Beam™ connector series is a miniaturized connector suited for a vast array of applications. The innovative design ensures its ability for deployment in the toughest environments where high performance, total reliability and reduced package size are critical. Benefiting from low insertion loss expanded beam technology, the precision optical alignment system is tolerant of water, mud, dust and other contaminants. Hermaphroditic coupling eliminates the need for adapters and male and female mating halves. The 185-002 Hi-Beam™ is ideally suited for environmental extremes where low maintenance and rapid deployment are necessary. Connectors and cable assemblies are field installable and repairable.

### Expanded Beam vs. Physical Contact Connectors

#### Physical Contact



Physical contact fiber optic connectors utilize butt-joint type contacts called termini. Mating pairs of termini may be integrated into virtually any connector shell design. The polished mating faces provide extremely low-loss transmission of optical signals but are best suited to clean and controlled environmental applications.

#### Expanded Beam



Expanded Beam connectors utilize a sealed lens to expand the emitting beam of light from the fiber media. The expanded beam is then refocused back into the fiber of the mating half. These sealed assemblies are ideally suited for environmental applications where optical connectors are subjected to repeated mating/unmating cycles.

### Series 185-002 Hi-Beam™ Performance Specifications

Insertion Loss	Multimode: 1.0 dB at 850/1300nm Singlemode: 1.5 dB at 1310/1550nm
Return Loss	Singlemode: Better than 34 dB unmated
Operating Temperature	-46°C to +71°C
Storage Temperature	-57°C to +85°C
Mating Durability	3000 mating cycles minimum
Cable Retention	1500N (cable dependent)
Bump	4000 bumps at 40g acceleration
Impact	8 drops from 0.9m per TIA/EIA-455-2, Method C, Service Class: Severe
Drop (Free Fall)	500 falls onto concrete from 1.2m
Vibration - Sinusoidal	10g Peak per TIA/EIA-455-11, Test Condition III
Vibration - Random	9g RMS per TIA/EIA-455-11, Test Condition VI-C, for 1.5 hours
Physical Shock (Half-sine Pulse)	50g Peak, 5 shocks per axis (30 shocks total) per TIA-455-14, Test Condition A
Water Immersion	Depth of 15m for 24 hours per TIA-455-74

F





HARSH-ENVIRONMENT

# Opto-Electronic Interconnect Solutions

Unlock the huge bandwidth of optical fiber and dramatically reduce the size and weight of interconnect systems

Glenair leverages its extensive portfolio of military and aerospace interconnect products to bring you ruggedized opto-electronic solutions, converting signals between the electrical domain and the fiber domain. These opto-electronic products are designed for harsh military/aerospace system and subsystem environments and will operate reliably over very wide temperature ranges and high shock and vibration conditions; they have been optimized to minimize size, weight and power and offer electrical-to-fiber conversion for Ethernet, video, signal aggregation and high-speed digital signals.

Glenair also offers integration of electronics or opto-electronics into rugged connector packages and cable assemblies per specific customer requirements. We offer rapid response in-house electrical/PCB design, and mechanical connector/backshell engineering from our vertically integrated factory. Our product portfolio is constantly evolving. Please contact Glenair for the latest developments, or custom solutions.

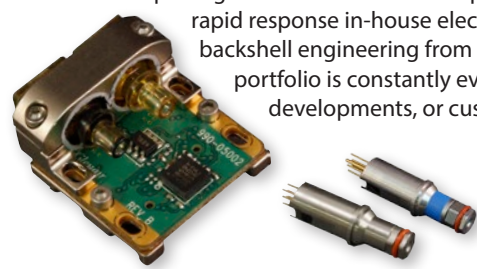

Technology can be integrated into mil-standard connectors or ruggedized packaging to suit any application

## ADVANTAGES OF GLENAIR OPTO-ELECTRONICS

- Reduced size, weight, and power consumption
- Leverages the virtues of fiber optics: **EMI immunity, network security, increased transmission distance and high bandwidth**
- High shock and vibration to support mil/aero applications
- Wide operating temperature range: **-40°C to +85°C and beyond**
- Designed IAW military and aviation requirements: **MIL-STD-883, MIL-STD-461, DO-160 and others**

## SERIES 050 OVERVIEW Harsh-Environment, Small Form-Factor Opto-Electronic Interconnect Solutions

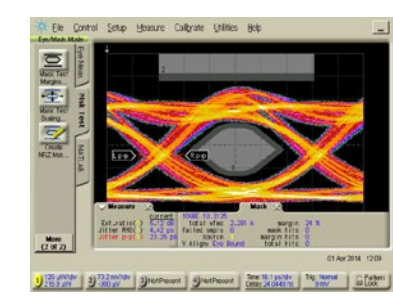

## PROVEN-PERFORMANCE OPTO-ELECTRONIC INTERCONNECT SOLUTIONS

- Military, industry-standard and custom connector integration
- Custom aggregation media converters
- Integration of active components into cable assemblies
- Link testing and qualification

Laboratory link test and qualification data for harsh-environment opto-electronic solutions are available—just contact the factory



SMPTE 3G - SDI at -40°C  
Pathological Case 3

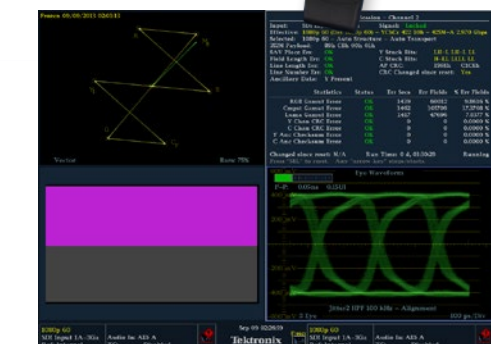

SMPTE 3G - SDI at +90°C  
Pathological Case 3

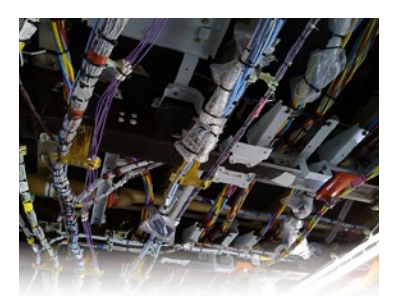

For more information contact Glenair at 818-247-6000 or visit our website at [www.glenair.com](http://www.glenair.com) U.S. CAGE code 06324





SIZE 8

# Opto-Electronic Contacts

Size 8 Opto-electronic contacts transmit and receive differential CML or LVPECL electrical signals over Multimode fiber optic cable. Transmitters consist of a laser driver or LED driver with a temperature compensation circuit to maintain optical power over the entire operating temperature range, and a 850nm VCSEL laser or a 1300nm LED. Receivers consist of a PIN Photo Detector, a Transimpedance Amplifier with automatic gain control circuit, and a Limiting Amplifier. Differential output data signals are LVPECL or CML compatible. The transmitter has a Tx Disable pin to turn off transmitter output.

- **Fast and Gigabit Ethernet, DVI, HDMI video capable transmitter and receiver-equipped contacts**
- **ARINC 664, 801, 803, 804 and 818 standard compliant**
- **Link distances up to 500 meters, multimode**
- **Single, 3.3 V power supply**
- **Wave-solderable termination with RoHS-compliant solders**



- **Transmit (Tx) and Receive (Rx) Opto-Electronic contacts for use in ARINC 600 and other size #8 cavity equipped connectors**
- **Current offerings include 1.25mm ARINC 801 and 2.5mm ELIO® solutions**

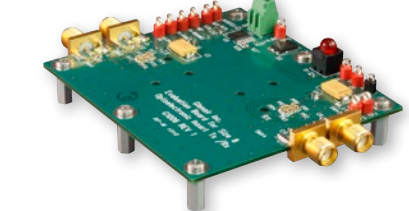
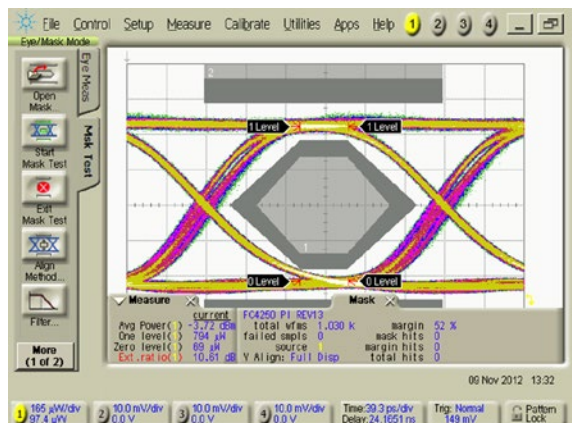

Evaluation Test Boards Available

## Size 8 Opto-Electronic Transmitter and Receiver Contacts for Ethernet, Video and High-Speed Data

PRODUCT SELECTION GUIDE

### TRANSMITTER AND RECEIVER CONTACTS, 850nm LASER, ARINC 801 1.25mm TERMINUS



Size 8 Opto-electronic contacts transmit and receive differential CML electrical signals over Multimode fiber optic cable. Transmitters consist of a laser driver with a temperature compensation circuit to maintain optical power over the entire operating temperature range, and a 850nm VCSEL laser. Receivers consist of an 850nm PIN Photo Detector, a Transimpedance Amplifier with automatic gain control circuit, and a Limiting Amplifier. Differential output data signals are CML compatible. The transmitter has a Tx Disable pin to turn off transmitter output and a Tx Fault pin to signal a fault condition. Receiver includes a CMOS compatible Loss of Signal Indicator to prevent invalid data.

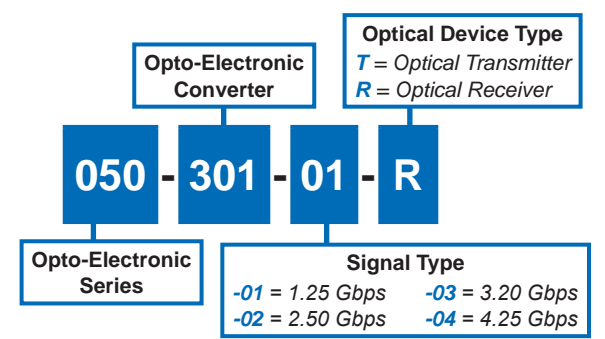

### TRANSMITTER AND RECEIVER CONTACTS, 850nm LASER, ELIO® 2.5mm TERMINUS



Size 8 Opto-electronic contacts transmit and receive differential CML electrical signals over Multimode fiber optic cable. Transmitters consist of a laser driver with a temperature compensation circuit to maintain optical power over the entire operating temperature range, and a 850nm VCSEL laser. Receivers consist of an 850nm PIN Photo Detector, a Transimpedance Amplifier with automatic gain control circuit, and a Limiting Amplifier. Differential output data signals are CML compatible. The transmitter has a Tx Disable pin to turn off transmitter output and a Tx Fault pin to signal a fault condition. Receiver includes a CMOS compatible Loss of Signal Indicator to prevent invalid data.

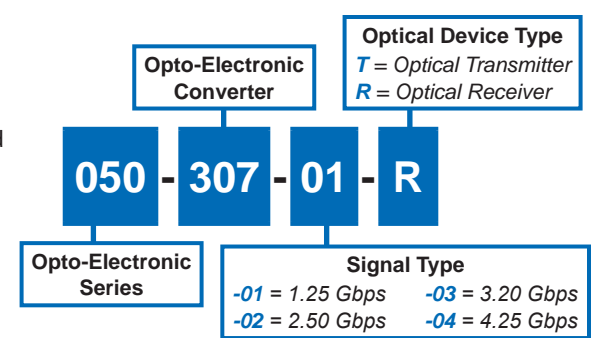

### TRANSMITTER AND RECEIVER CONTACTS, 1300 nm LED, ARINC 801 1.25mm TERMINUS



Size 8 Opto-electronic contacts transmit and receive differential LVPECL electrical signals over Multimode fiber optic cable. Transmitters consist of an LED driver with a temperature compensation circuit to maintain optical power over the entire operating temperature range, and a 1300nm LED. Receivers consist of a PIN Photo Detector, a Transimpedance Amplifier with automatic gain control circuit, and a Limiting Amplifier. Differential output data signals are LVPECL. The transmitter has a Tx Disable pin to turn off transmitter output.

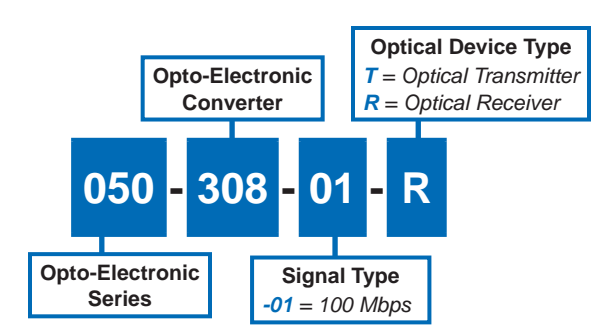

### OPTO-ELECTRONIC CONTACT EVALUATION BOARD



050-301

The evaluation board is designed as an interface to allow evaluation of the size 8 transmitters or receivers. Devices are powered through the 3.3V and GND connections. For the transmitter fault pin can be monitored and the transmitter disable can be controlled via an external voltage supply. For the receiver, loss of signal (LOS) state can be monitored.

- Test configuration options:
- Transmitter only
  - Receiver only, and
  - Both transmitter and receiver either in a single link or two separate links.





# Harsh-Environment PCB-Mount Transceivers, Transmitters and Receivers

## PRODUCT SELECTION GUIDE



visit [glenair.com](http://glenair.com) for detailed product datasheets



HIGH-SHOCK, HIGH-VIBRATION

# PCB-Mount Opto-Electronics

Connectorized, high-density, board-mount transceivers built for rugged vibration and shock applications up to 10Gbps

Glenair PCB mount transceivers are ruggedized harsh-environment equivalents to SFP transceivers but with mechanical design suited to the harsh temperature and vibration environments found in Military, Aerospace and Other applications. PCB mount optical transceivers support optional Digital Monitoring Interface (DMI) features in accordance with SFF 8472. The Transceiver is comprised of a transmitter section and a receiver section that reside on a common package and interface with a host board through a high-speed electrical connector.

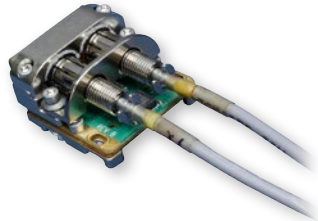
- Smallest footprint available
- Passed jet fighter and space launch shock and vibration testing
- No soldering required
- CML 100 Ohm differential input and output
- -40°C to +85°C operating temperature range—extended temperature ranges available

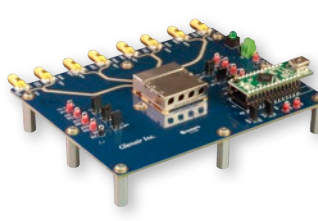
			
GC fiber optic connector retained with mounting screws to withstand high vibration and shock	PCB-mount opto-electronics feature Samtec high-speed surface-mount connectors	Dual-transceiver, Quad-Transmitter and Quad-Receiver form factor with ARINC 801 contacts	Evaluation boards for all PCB mount transceiver configurations are available

### General Purpose Applications:

High-Speed Digital balanced signals (i.e. 4B/5B, 8B/10B, 62B/64B etc)  
Fast Ethernet, Gigabit Ethernet, 10G Ethernet Fiber Channel (1X, 2X, 4X, 8X), ARINC 818, AFDX, SFPDP, Serial Rapid I/O (sRIO)

### Video Applications

DVI, ARINC 818, SMPTE (SDI, HD-SDI, 3G-SDI)

Part Number	Description	Data Rate (Gbps)	Wavelength (nm)	Laser Type	Number of Transmitters	Number of Receivers	Number of Fibers	Fiber Type	General Purpose Video (DVI, ARINC 818)	Video SMPTE HD-SDI	Video SMPTE 3G-SDI	Distance
050-315	PCB Mount OE Transceiver 5G, MMF	0.1-5	850	VCSEL	1	1	2	MMF	Y	Y	N	1m-500m
050-316	PCB Mount OE Dual-Transmitter 5G, MMF	0.1-5	850	VCSEL	2	0	2	MMF	Y	Y	N	1m-500m
050-317	PCB Mount OE Dual-Receiver 5G, MMF	0.1-5	850	N/A	0	2	2	MMF	Y	Y	N	1m-500m
050-318	PCB Mount OE Transceiver, 4G, SMF	0.1-4.25	1310	FP	1	1	2	SMF	Y	Y	N	1m-10km
050-319	PCB Mount OE Dual Transmitter, 1310nm FP, 4G, SMF	0.1-4.25	1310	FP	2	0	2	SMF	Y	Y	N	1m-10km
050-320	PCB Mount OE Dual Receiver, 1310nm, 4G, SMF	0.1-4.25	1310	N/A	0	2	2	SMF	Y	Y	N	1m-10km
050-321	PCB Mount OE Transceiver, 1300nm LED, 200M, MMF	0.05-2	1300	LED	1	1	2	MMF	Y	N	N	2km
050-322	PCB mount 10Gbps XVR, 1310nm FP, 2km, SMF	5-10.5	1310	FP	1	1	2	SMF	Y	Y	N	1m-2km
050-324	PCB Mount OE Transceiver, 1310nm DFB, 4G, SMF	0.1-4.25	1310	DFB	1	1	2	SMF	Y	Y	N	1m-40km
050-325	PCB Mount OE Dual Transmitter, 1310nm DFB, 4G, SMF	0.1-4.25	1310	DFB	2	0	2	SMF	Y	Y	N	1m-40km
050-326	PCB Mount OE Dual Receiver, 1310nm DFB, 4G, SMF	0.1-4.25	1310	N/A	0	2	2	SMF	Y	Y	N	1m-40km
050-327	PCB mount 10Gbps SR Serial XVR, 850nm, MMF	5-10.5	850	VCSEL	1	1	2	MMF	Y	Y	N	1m-400m
050-328	PCB mount 10Gbps XVR, 1310nm DFB, 10km	5-10.5	1310	DFB	1	1	2	SMF	Y	Y	N	1m-10km
050-331	PCB Mount OE Dual-Transmitter SMPTE 3G-SDI	2.97	850	VCSEL	2	0	2	MMF	N	N	Y	1m-1km
050-332	PCB Mount OE Dual-Receiver SMPTE 3G-SDI	2.97	850	N/A	0	2	2	MMF	N	N	Y	1m-1km
050-333	PCB Mount OE Dual-Transceiver 5G MMF, ARINC 801	0.1-5	850	VCSEL	2	2	4	MMF	Y	Y	N	1m-500m
050-336	PCB Mount OE Quad-Transmitter 5G MMF, ARINC 801	0.1-5	850	VCSEL	4	0	4	MMF	Y	Y	N	1m-500m
050-337	PCB Mount OE Quad-Receiver 5G MMF, ARINC 801	0.1-5	850	N/A	0	4	4	MMF	Y	Y	N	1m-500m
050-339	PCB Mount OE Dual-Transceiver, 10G MMF, ARINC 801	0.1-5	850	VCSEL	2	2	4	MMF	Y	Y	N	1m-400m
050-340	SINGLE FIBER Bidirectional Transceiver, 2.5G, SMF	0.1-2.5	1310/ 1550	FP/FP	1	1	1	SMF	Y	Y	N	1m-2km
050-341	SINGLE FIBER Bidirectional Transceiver, 10G, SMF	5-10.5	1310/ 1550	DFB/DFB	1	1	1	SMF	Y	Y	N	1m-10km
050-342	CWDM Transceiver, 2.5G, SMF	0.1-2.5	CWDM	DFB	1	1	2	SMF	Y	Y	N	1m-20km
050-343	CWDM Transceiver, 10G, SMF	5-10.5	CWDM	DFB	1	1	2	SMF	Y	Y	N	1m-10km

Evaluation Boards		
Part No.	Description	for testing Part Number(s)
050-329	EVALUATION BOARD supporting Board Mount Transceivers, 1-10Gbps	050-315, 050-318, 050-321, 050-324
050-330	EVALUATION BOARD supporting Board Mount Dual Transmitters and Board Mount dual Receivers	050-316, 050-317, 050-319, 050-320, 050-325, 050-326, 050-331, 050-332
050-334	EVALUATION BOARD supporting PCB Mount Dual-Transceiver 050-333+	050-333
050-338	EVALUATION BOARD	050-336, 050-337
050-344	FMC Connectivity Card	All Glenair PCB Mount Components

Accessories		
Part No.	Description	Details
FA02454	Fiber Optic jumper cable, GC	Singlemode or multimode connects transceiver to mil/aero connector
FA03286	Fiber Optic jumper cable, ARINC 801	Singlemode or multimode connects transceiver to mil/aero connector
059-0007	PCB Threaded Insert	Simplifies installation of PCB transceivers





# Opto-Electronic Connectors for Ethernet, Video, and High-Speed Data Applications



## PRODUCT SELECTION GUIDE

visit [glenair.com](http://glenair.com) for detailed product datasheets

SMALL FORM-FACTOR • HARSH-ENVIRONMENT

# Opto-Electronic Connectors

## Environmentally sealed, D38999 type triple-start connectors housing turnkey copper-to-fiber transceiver technology

Glenair is able to offer our Opto-Electronic solutions customers turnkey multichannel receptacle connectors housing integrated transceiver technology for fast/gigabit Ethernet, DVI and HDMI video, as well as various high-speed data transfer protocols. The two available connector designs incorporate Glenair small form-factor ARINC 801 type opto-electronic contacts (050-301) or an ELIO® equipped configuration that intermates with the standard ELIO® 2.5mm fiber optic terminus (050-307). Receptacles are populated with factory-tested size #8 contacts, and are ready for immediate use as fiber-optic-to-electrical circuit board I/O connectors. Special size #8 cavity adapters are also available to enable construction of compatible plug connectors on the cable side.

- **Catalog solutions include:**  
**2.5mm ELIO® solution for multimode Ethernet, video, and high-speed data applications**  
**1.25mm ARINC 801 multimode fiber optic terminus solution for Ethernet, video, and high-speed data**
- **Made-to-order configurations with a wide range of connector packages including Glenair Series 80 Mighty Mouse**



Special size #8 cavity adapters facilitate construction of standard fiber optic plug connectors that intermate with the size #8 opto-electronic transceiver contacts

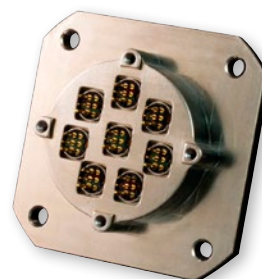

Opto-electronic receptacle connectors are populated with size #8 contacts, and ready for immediate assembly in I/O to circuit board applications

ELIO® is a registered trademark of SOURIAU

	Part No.	Description
	<b>050-304</b>	<b>050-304 MIL-DTL-38999 Series III Type Receptacle Connectors with Size 8 Opto-Electronic Contacts</b> The 050-304 series of Active Opto-electronic sealed panel mount connectors offers customers the power to convert from electrical to fiber optic signals within a D38999 connector to support high speed fiber optic transmission in harsh environments. The 050-304 incorporates size 8 active contacts in one of three standard configurations to enable optical Transmitters, optical Receivers or Optical Transceivers, or custom configurations.
	<b>059-0001</b>	<b>059-0001 Size 8 cavity adapter kit for 1.25mm ARINC 801 terminus</b> Size 8 cavity adapter will convert D38999 size 8 cavities (Twinax, Coax, Quadrx or power) into ARINC 801 fiber optic cavities. Kit includes the adapter and an ARINC 801 terminus.
	<b>059-0002</b>	<b>059-0002 Size 8 cavity adapter for ELIO® 2.5mm terminus</b> Size 8 cavity adapter will convert D38999 size 8 cavities (Twinax, Coax, Quadrx or power) into ELIO® fiber optic cavities per EN4531.
 <i>(patent pending)</i>	<b>050-313</b>	<b>050-313 Opto-Electronic Transceiver, MIL-DTL-38999 Type 2.5mm ELIO® Compatible, 100Mbps – 4.25Gbps</b> Glenair 050-313 is a D38999 Type 11-02 receptacle connector incorporating an opto-electronic transceiver operating from 100Mbps to convert electrical signals to multimode fiber. The Glenair optical transceiver is ideal for harsh-environment, extreme shock, vibration and temperature avionics and military applications where copper cable link distance, bandwidth, weight or bulk make the use of twisted pair, Twinax or Quadrx copper conductors unacceptable.
	<b>050-303</b>	<b>050-303 Opto-Electronic Receiver with Mighty Mouse connectors, 100Mbps – 2.5 Gbps</b> Glenair 050-303 optical transceiver, connectorized with Series 805 Mighty Mouse connectors, employs state-of-the-art opto-electro-mechanical technology to provide effective harsh environment fiber-optic interconnect solutions for high-speed digital data.











# VIDEO Copper-to-Fiber Media Converters

Reduced form factor media converters for harsh-environment video applications

Glenair Copper-to-Fiber-Optic Video Media Converters enable extended link distances, improved EMI and security in harsh environments and provide solutions for both MMF and SMF applications. These media converters support ruggedized military systems applications and are tailored to support a variety of Video protocols including DVI, HDMI, SMPTE (SDI, HD-SDI and 3G-SDI), ARINC 818 and more. Many options for mil-spec and military-grade electrical and fiber optic connectors are available. Contact Glenair for custom configurations, application-specific designs and engineering services.



- Fiber Link 500m with MMF
- Fiber Link 10km with SMF
- 38999 with MIL-STD-1560 and custom contact arrangements—including quadrax and coaxial contact options
- Mighty Mouse electrical and fiber optic connectors
- Fiber Optic connectors including D38999, M28876, GHD, NGCON (M64266), HMA (M83526), and GFOCA
- Power supply functions with wide input-voltage ranges
- DVI, HDMI, SMPTE, ARINC 818
- Advanced monitor & control functions via serial interface to facilitate network management and BIT

## Copper-to-Fiber Media Converters for Video Applications

PRODUCT SELECTION GUIDE



visit [glenair.com](http://glenair.com) for detailed product datasheets

### MIL-DTL-38999 SERIES III TYPE DVI VIDEO MEDIA CONVERTER

How To Order

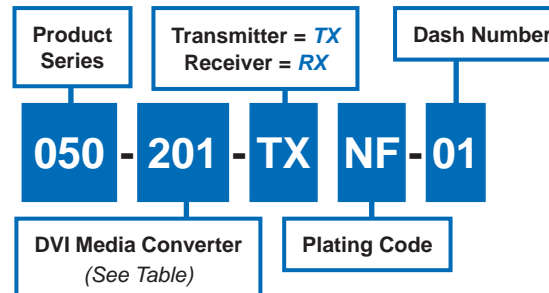

ENVIRONMENTAL PERFORMANCE

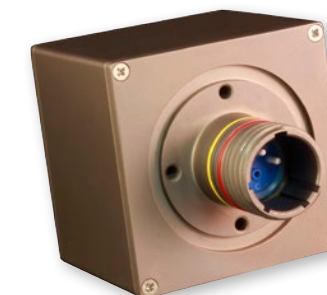

- -40°C to +85°C operating temperature range
- Meets MIL-STD-810 Mechanical Shock and Vibration
- Meets MIL-STD-1344 immersion resistance

Video Media Converter Selection Guide		
	050-201	DVI Copper-to-Fiber Media Converter
	050-203	DVI Copper-to-4-Fiber, VCSEL, DO160 Lightning Strike level 3 and "dirty" 28V power
	050-206	4 Channel SMPTE HD-SDI & 3G-SDI Transmitter or Receiver
	050-204	4 Channel 3G-SDI MMF TX and 3G-SDI MMF RX, GHD Fiber, Mighty Mouse (Coax and Power).
	050-205	DVI Copper-to-Fiber Media Converter, Inline

### VIDEO MEDIA CONVERTER FUNCTIONAL BLOCK DIAGRAM

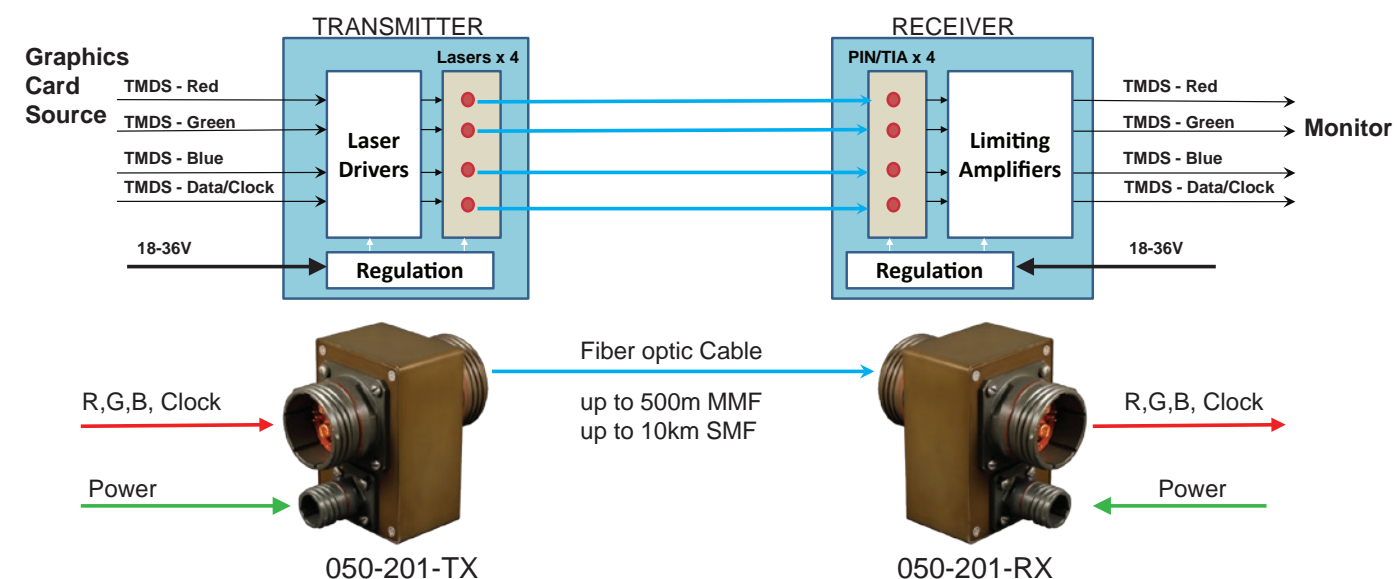





# Copper-to-Fiber Media Converters Multiplexing Signal Aggregator



## PRODUCT SELECTION GUIDE

visit [glenair.com](http://glenair.com) for detailed product datasheets

## SIGNAL AGGREGATION Copper-to-Fiber Media Converters

Combine multiple electrical signals into a high-speed fiber data stream

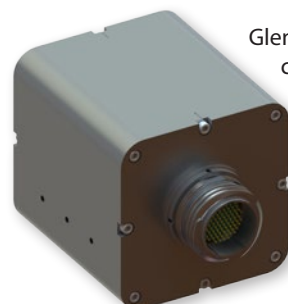

Glenair signal aggregation media converters integrate a set of compact opto-electronic modules to digitize and/or aggregate multiple common signal types, and combine them onto high-data-rate serial optical fiber channels. Silicon field-programmable gate array (FPGA) technology provides a flexible way to accommodate many signal I/O types.

- Dramatically reduce size, weight, wire count, and shielding of copper cables
- Leverage the high bandwidth of optical fiber by multiplexing many lower-data-rate signals onto a few fibers
- One high-speed opto-electronic interface can serve practically all signal types
- Ideal solution to enable optical rotary joints
- -40°C to +85°C operating temperature range
- Meets MIL-STD-810 Mechanical Shock and Vibration
- Meets MIL-STD-1344 immersion resistance
- Advanced monitor & control functions via serial interface to facilitate network management and BIT

### Signal Aggregation Media Converter Selection Guide

050-501	12-Channel RS422 Copper-to-Fiber Media Converter
050-502	6x RS-422 and 6x ARINC 429 Copper-to-Fiber Media Converter
050-503	DVI/HDMI (Dual fiber) + USB(HID) interface (KVM) Copper-to-Fiber Media Converter
050-504	CAN Bus "bridge"(ARINC 825), ARINC 429, ARINC 664 (AFDX ethernet) DO-160 compliant Copper-to-Fiber Media Converter
050-505	2x Ethernet, 2xRS-422 or 2xRS-232 (422 & 232 not simultaneously) Copper-to-Fiber Media Converter

### SIGNAL AGGREGATOR FUNCTIONAL DIAGRAMS

- One compact LRU digitizes or aggregates multiple electrical signals on copper using an FPGA
- FPGA digitizes and serializes the signals onto a high-speed data stream
- Opto-electronic converters get the serialized signals on and off the optical fiber

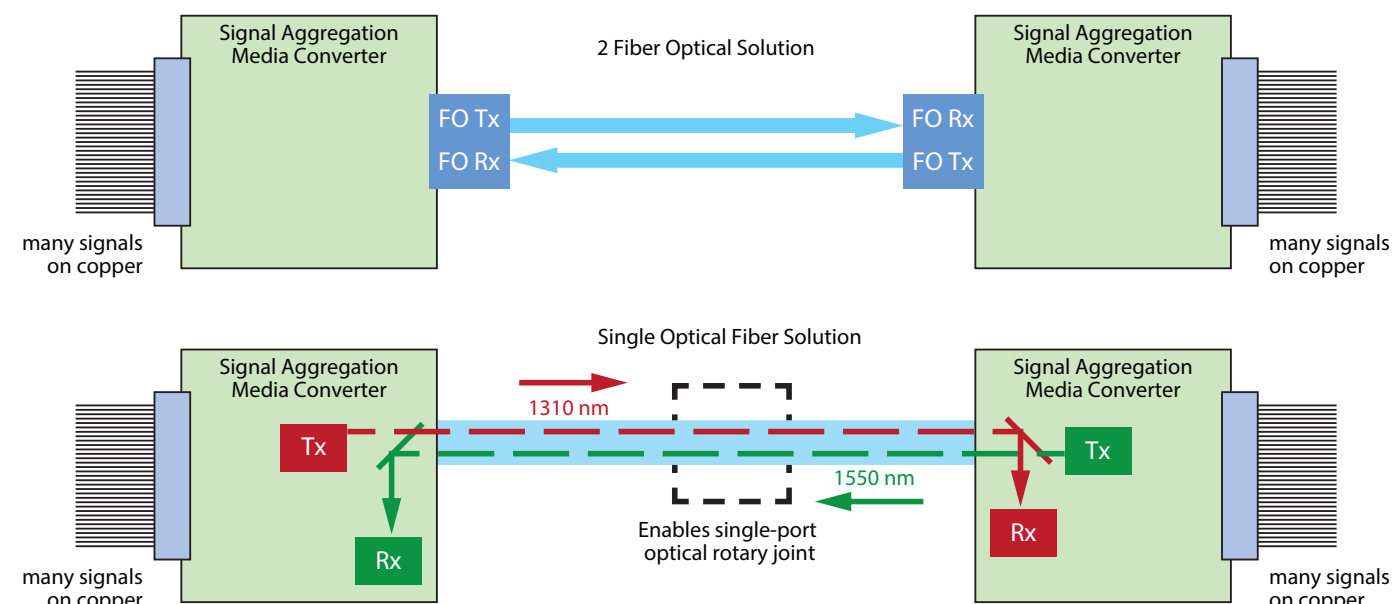
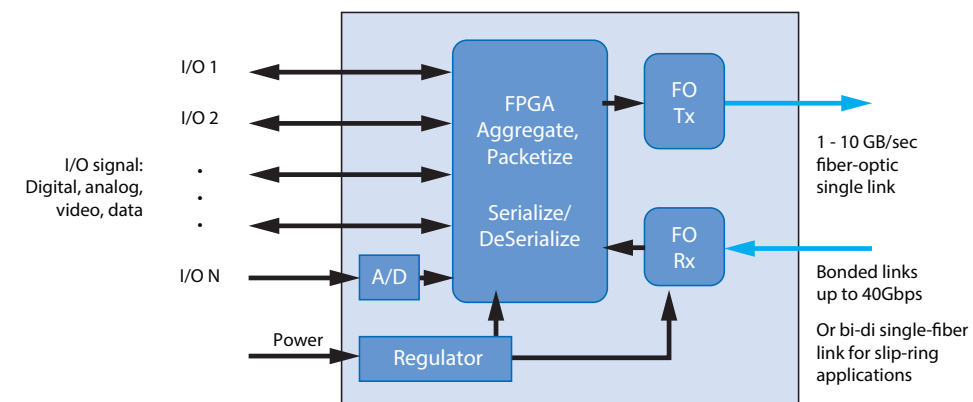

### FPGA MAIN BOARD AND DAUGHTER CARD ARCHITECTURE CAN HANDLE MANY SIGNAL TYPES

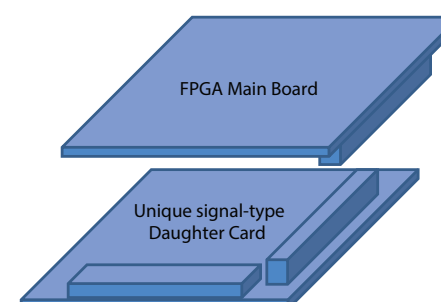

#### SERIAL

- RS422/RS485
- RS232
- USB
- MIL-STD-1553
- CAN Bus
- ARINC 429
- SMBus
- I2C
- SPI
- Ethernet 10/100/1000

#### VIDEO

- DVI
- HDMI
- SMPTE SDI
- SMPTE HD-SDI
- SMPTE 3G-SDI
- ARINC 818
- VGA

#### ANALOG

- RF/IF Sampling
- Analog Sensor Data

Contact the factory for other signal formats and custom configurations





# Small Form-Factor Ethernet Switches and Breakout Cables

## PRODUCT SELECTION GUIDE



visit [glenair.com](http://glenair.com) for detailed product datasheets

# SMALL FORM-FACTOR Ethernet Switches and Breakout Cables

Glenair unmanaged Ethernet switches are layer 2 switches with Auto negotiation and Auto MDI / MDIX circuitry that enables port expansion with IEEE-802.3U 10/100/1000Base-T Ethernet ports. Developed for use in harsh environment applications, the electronics are incorporated into a panel-mountable housing that is sealed against liquid and solid contaminants and designed for shock and vibration resistance. Standard connector interfaces include high-performance size- and weight-saving Glenair Series 805 Mighty Mouse jam nut receptacles and M28876 type fiber-optic connectors.

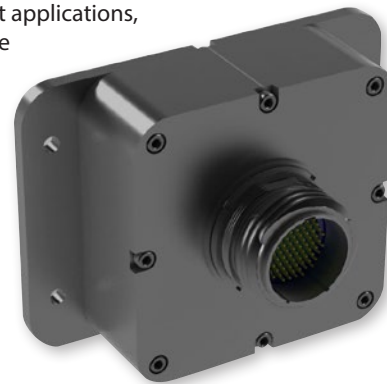

- Unmanaged—plug and play operation—no configuration required
- Jumbo frame support in all speeds (10/100/1000 Mbps)
- Operating temperature range: -40°C to +85°C
- Standard ultraminiature Mighty Mouse electrical and M28876 type fiber optic connector interfaces
- Experienced opto-electronic engineering services available for special connector and form-factor configurations
- Breakout cables with industry-standard connector interfaces available

### 052-101 7-PORT UNMANAGED ETHERNET SWITCH

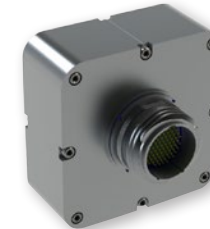

Form 1 (no flanges)

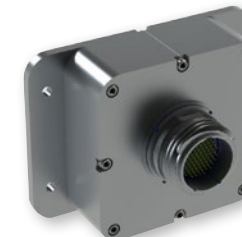

Form 2 (with flanges)

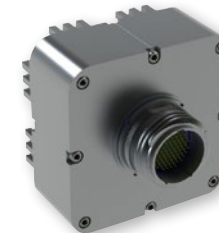

Form 3 (heat sink)

- 7 copper (10/100/1000 Mbps) Ethernet ports per IEEE 802.3:2005
- Non-Blocking switch fabric allows 1000 Mbps data rate on all 7 ports simultaneously
- Cable link distances up to 100 Meters (EIA/TIA Cat-5E)
- Full duplex flow control per IEEE Std 802.3X and half duplex back pressure, symmetric and asymmetric
- Shock, vibration and immersion resistant per MIL-STD-810F
- Auto sensing of half or full duplex operation
- Mighty Mouse Series 805 shell is water-tight to MIL-STD-810 when mated
- 3 form-factors available

### 050-118 5-PORT UNMANAGED ETHERNET SWITCH



- 1 PORT : 10/100/1000 BASE-T consistent with IEEE 802.3
- 4 PORTS: 1000BASE-LX (IEEE 802.3)
- Non-blocking switch fabric allows 1000 Mbps on all ports
- Material/Plating: Aluminum with Cadmium Olive Drab over electroless Nickel (500 hours salt spray plating)
- 6 Status LEDs to Denote: (Power, Ethernet activity with one LED for each of the 5 ports)
- 4 M28876 type fiber-optic connectors
- Mighty Mouse ultraminiature electrical connector interface
- IP67 in mated condition

### BREAKOUT CABLES FOR 7-PORT ETHERNET SWITCH



How To Order

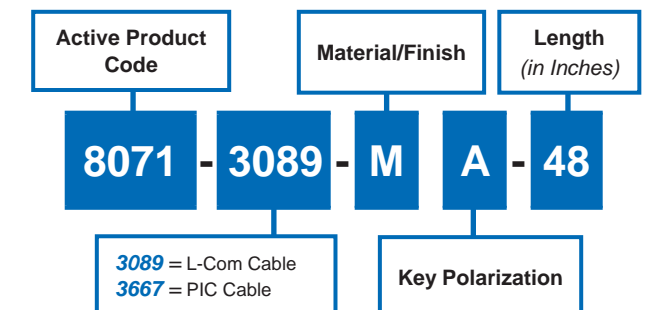

F



# Shrink Boots, Jackets, and Braided Shielding for extreme environmental and EMI/RFI protection

Shrink Boots, Jackets, and Braided Shielding Product Selection Guide



Series 77 Full Nelson Environmental Heat Shrink Boots



Piggyback Boot Connector Adapters



Duraelectric™, Viton® and other Cable and Conduit Jacketing



AmberStrand® Lightweight Composite EMI/RFI Shielding

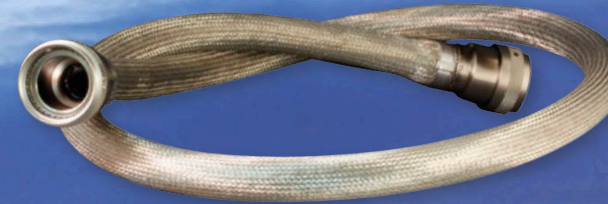

ArmorLite™ Lightweight Stainless Steel EMI/RFI Shielding

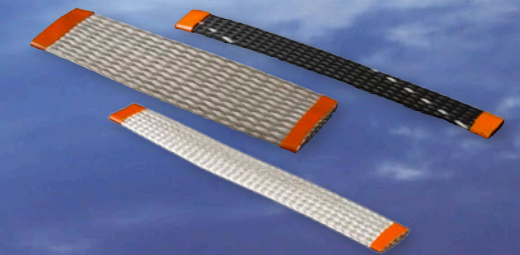

EMI/RFI Metal Braided Shielding and Fabric Braided Sleeving

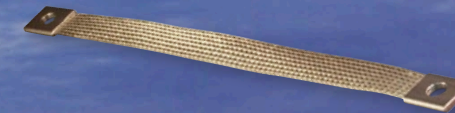

MIL-DTL-24749 Type IV Qualified Ground Straps



Lightweight ArmorLite™ Microfilament Ground Straps



Cable assemblies, exposed to harsh environmental, mechanical and electromagnetic stress are routinely equipped with boots, shields, and jackets designed to protect critical circuits from damage. Glenair offers a complete, turnkey solution to cable and conduit protection that includes innovative lightweight braided EMI/RFI shielding, revolutionary Duraelectric™ jacketing, and our full spectrum Series 77 Full Nelson environmental heat shrink boot product family.



For more information contact Glenair at 818-247-6000 or visit our website at [www.glenair.com](http://www.glenair.com) U.S. CAGE code 06324





**Mechanical and environmental protection/strain relief for connector-to-cable transitions**

- Standard, short, long and 90° lipped and lipless boots
- Choice of six boot materials and a complete range of high-performance adhesive types
- A wide range of colors including desert tan
- The industry's largest selection of metal and composite shrink boot adapters
- All popular part numbers in stock and ready for same-day shipment

*The industry's broadest selection of heat shrink products*

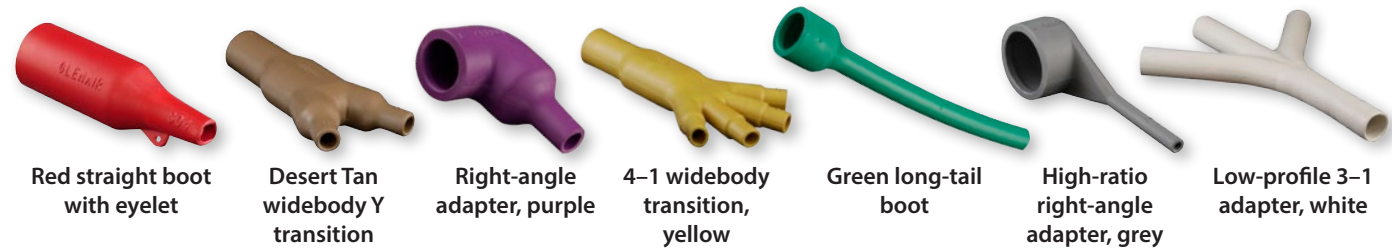

Material Color Options for Type 1 High Performance Elastomer Boots and Transitions					
Mod Code	Color	Similar to (Reference)	Mod Code	Color	Similar to (Reference)
632 B	Blue	PANTONE 3005U	632 R	Red	PANTONE 1797U
632 E	Grey	FED-STD-595; #36270	632 T	Tan	FED-STD-595; #33446
632 G	Green	PANTONE 355U	632 W	White	FED-STD-595; #37875
632 P	Purple	FED-STD-595; #37100	632 Y	Yellow	PANTONE YELLOW U
632 O	Orange	FED-STD-595; #32300	Standard	Black	FED-STD-595; #37038

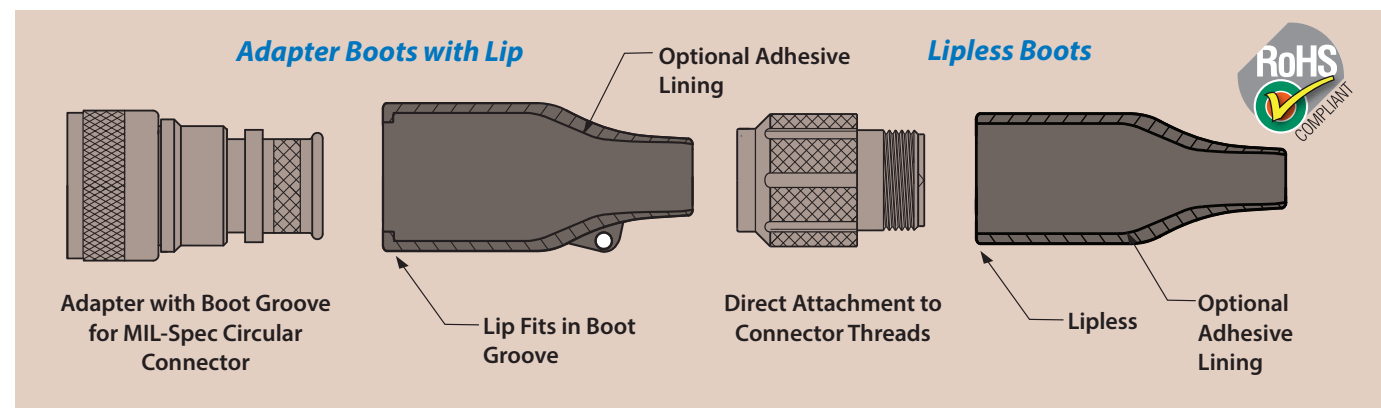

Shrink Boot Typical Material Properties						
Property	Type 1 High Performance Elastomer	Type 2 Zero Halogen Polyolefin	Type 3 General Purpose Polyolefin	Type 5 Viton® Fluoroelastomer Blend	Type 6 High Performance Elastomer Alloy	Type 7 Flexible Polyolefin
Flexibility	Semi-rigid	Semi-flexible	Flexible	Flexible	Flexible	Highly Flexible
Operating Temperature Range	-75°C to +150°C	-30°C to +135°C	-55°C to +135°C	-55°C to +150°C	-55°C to +135°C	-55°C to +135°C
Shrink Temperature (min.)	135°C	135°C	120°C	135°C	135°C	135°C
Tensile Strength (psi)	1700	1100	1400	2200	1500	1400
Elongation (% min.)	400	250	400	400	300	250
Long Term Heat Aging	3000 hrs, 150°C	3000 hrs, 135°C	168 hrs, 175°C	168 hrs, 150°C	168 hrs, 150°C	168 hrs, 175°C
Heat Shock	4 hrs, 215°C	4 hrs, 215°C	4 hrs, 225°C	4 hrs, 225°C	4 hrs, 220°C	4 hrs, 250°C
Heat Aging	168 hrs, 160°C	168 hrs, 160°C	168 hrs, 175°C	168 hrs, 150°C	168 hrs, 150°C	168 hrs, 175°C
Dielectric Strength (V/mil)	300	380	250	200	200	300
Volume Resistivity (ohm-cm)	10 <sup>13</sup>	10 <sup>12</sup>	10 <sup>12</sup>	10 <sup>10</sup>	10 <sup>10</sup>	10 <sup>12</sup>
Water Absorption (%)	0.5	0.5	0.5	0.5	0.5	0.5
Flammability	Burn Time <15 sec Burn Length <25mm	Burn Time <15 sec Burn Length <25mm	Burn Time <120 sec Burn Length <25mm	Burn Time <120 sec Burn Length <25mm	Burn Time <120 sec Burn Length <25mm	Burn Time <90 sec Burn Length <25mm
RoHS Compliant	Yes	Yes	Yes	Yes	Yes	Yes
Oxygen Index (% min.)		30				
Temperature Index (°C)		250				
Smoke Index (max.)		20				
Toxicity Index (max.)		3				

Glenair's complete vertical integration ensures high-availability heat-shrink boots for all connector types

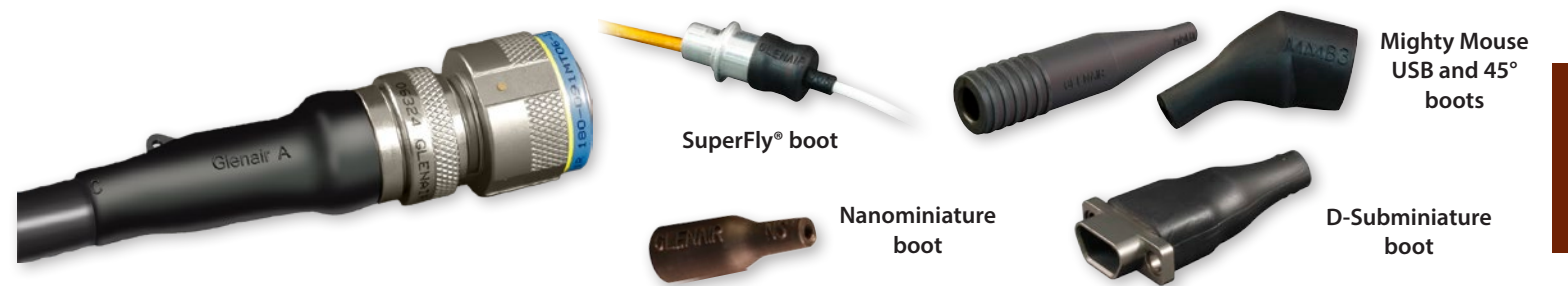

**SHRINK BOOT ADAPTERS SELECTION GUIDE**





**SERIES 77  
ENVIRONMENTAL  
SHRINK BOOTS**



**Glenair Environmental Shrink Boots Now TACOM Approved, In-Stock and Ready for Immediate Shipment**

High-performance Series 77 "Full Nelson" environmental shrink boots manufactured by Glenair in Glendale, California are now approved by the US Army Tank-Automotive Command (TACOM). Manufactured from high-temperature crosslinked elastomeric polymer material and/or caustic chemical-resistant Viton polymer, Glenair straight and right angle long-tail shrink boots, Y and T transitions, convoluted strain-relief boots and heat-shrinkable adapter shims have been added to the following source control documentation:

**Glenair Series 77 "Full Nelson" TACOM APPROVED Shrink Boots**

Description	Military Part Number	Glenair Part Number	Raychem Part Number	Hellermann Part Number	Description	Military Part Number	Glenair Part Number	Raychem Part Number	Hellermann Part Number
Heat Shrinkable Low Profile 3-Entry "Y" Transition	12273148-1**	770-009Y*05	381A301-**	492H412-*	Heat Shrinkable Straight Lipped 2-Entry Long Tail Boot	12273147-1**	770-020S*02	202F211-**	313F322-*
	12273148-2**	770-009Y*06	381A302-**	492H413-*		12273147-2**	770-020S*03	202F221-**	313F332-*
	12273148-3**	770-009Y*07-01	381A303-*01	492H414-*01		12273147-3**	770-020S*04	202F232-**	313F343-*
	12273148-4**	770-009Y*08-01	381A304-*01	492H415-*01		12273147-4**	770-020S*05	202F242-**	313F353-*
	12273148-5**	770-009Y*07	381A303-**	—		12273147-5**	770-020S*06	202F253-**	313F364-*
Heat Shrinkable Low Profile 3-Entry "T" Transition	12273162-1**	770-012T*01	301A511-**	412H622-*	12273147-6**	770-020S*07	202F263-**	313F374-*	
	12273162-2**	770-012T*02	301A512-**	412H623-*	12273147-7**	770-020S*08	202F274-**	313F385-*	
	12273162-3**	770-012T*03	301A513-**	412H624-*	Heat Shrinkable 90° Lipped 2-Entry Long Tail Boot	12273176-1**	770-021A*02	222F211-**	333F322-*
	12273162-4**	770-012T*04	301A514-**	412H625-*		12273176-2**	770-021A*03	222F221-**	333F332-*
12273163-1**	770-014*09	462A421-**	573H532-*	12273176-3**		770-021A*04	222F232-**	333F343-*	
12273163-2**	770-014*10	462A422-**	573H533-*	12273176-4**		770-021A*05	222F242-**	333F353-*	
12273163-3**	770-014*11	462A423-**	573H534-*	12273176-5**		770-021A*06	222F253-**	333F364-*	
Heat Shrinkable Low Profile 4-Entry 3:1 Transition	12273163-4**	770-014*12	462A424-**	573H535-*	12273176-6**	770-021A*07	222F263-**	333F374-*	
	12273164-1**	770-019SB*01	202E334-**	313E445-*	12273176-7**	770-021A*08	222F274-**	333F385-*	
Heat Shrinkable Adapter Shim Boot	12273164-2**	770-019SB*02	202E344-**	313E455-*	Heat Shrinkable Convoluted Strain Relief 2-Entry Boot	12273242-1**	770-022C*01	202C611-**	313C722-9
	12273164-3**	770-019SB*03	202E336-**	313E447-*		12273242-2**	770-022C*02	202C621-**	313C732-9
	12273164-4**	770-019SB*04	202E346-**	313E457-*		12273242-3**	770-022C*03	202C632-**	313C743-9
	12273242-1**	770-022C*01	202C611-**	313C722-9		12273242-4**	770-022C*04	202C642-**	313C753-9
12273242-2**	770-022C*02	202C621-**	313C732-9	12273242-5**		770-022C*05	202C653-**	313C764-9	
12273242-3**	770-022C*03	202C632-**	313C743-9	12273242-6**		—	202G621-**	—	
12273242-4**	770-022C*04	202C642-**	313C753-9	12273242-7**		—	202G632-**	—	
12273242-5**	770-022C*05	202C653-**	313C764-9	12273242-8**		—	202C642-**	—	
12273242-6**	—	—	—	12273242-9**		—	202C653-**	—	
12273242-7**	—	—	—						
12273242-8**	—	—	—						
12273242-9**	—	—	—						

**VG QUALIFIED SHRINK BOOTS AND ADHESIVES**



VG Standards are established by the Deutsches Institut für Normung (DIN) and are widely used in European defense programs. Glenair Type 2 shrink boots are qualified to VG95343 Part 28, and our adhesives are qualified to VG95343 Part 18. Consult Glenair UK for price and delivery.

**SERIES 77  
TACOM-Approved Environmental Shrink Boots**

Expanded Cross-Reference: TACOM-to-Glenair Shrink Boot Part Numbers					
TACOM #	GLENAIR #	TACOM #	GLENAIR #	TACOM #	GLENAIR #
12273147-120	770-020S602	12273162-110	770-012T601	12273176-120	770-021A602
12273147-220	770-020S603	12273162-210	770-012T602	12273176-220	770-021A603
12273147-320	770-020S604	12273162-310	770-012T603	12273176-320	770-021A604
12273147-420	770-020S605	12273162-410	770-012T604	12273176-420	770-021A605
12273147-520	770-020S606	12273162-120	770-012T501	12273176-520	770-021A606
12273147-620	770-020S607	12273162-220	770-012T502	12273176-620	770-021A607
12273147-720	770-020S608	12273162-320	770-012T503	12273176-720	770-021A608
12273147-130	770-020S502	12273162-420	770-012T504	12273176-130	770-021A502
12273147-230	770-020S503	12273163-110	770-014609	12273176-230	770-021A503
12273147-330	770-020S504	12273163-310	770-014611	12273176-330	770-021A504
12273147-430	770-020S505	12273163-410	770-014612	12273176-430	770-021A505
12273147-530	770-020S506	12273163-120	770-014509	12273176-530	770-021A506
12273147-630	770-020S507	12273163-220	770-014510	12273176-630	770-021A507
12273147-730	770-020S508	12273163-320	770-014511	12273176-730	770-021A508
12273148-110	770-009Y605	12273163-420	770-014512	12273242-110	770-022C601
12273148-210	770-009Y606	12273164-110	770-019SB601	12273242-210	770-022C602
12273148-310	770-009Y607-01	12273164-210	770-019SB602	12273242-310	770-022C603
12273148-410	770-009Y608-01	12273164-310	770-019SB603	12273242-410	770-022C604
12273148-510	770-009Y607	12273164-410	770-019SB604	12273242-510	770-022C605
12273148-120	770-009Y505	12273164-120	770-019SB501	12273242-120	770-022C501
12273148-220	770-009Y506	12273164-220	770-019SB502	12273242-220	770-022C502
12273148-320	770-009Y507-01	12273164-320	770-019SB503	12273242-320	770-022C503
12273148-420	770-009Y508-01	12273164-420	770-019SB504	12273242-320	770-022C503
12273148-520	770-009Y507			12273242-420	770-022C504
				12273242-520	770-022C505

**TACOM Approved Shrink Boot Material Properties**

Property	Viton® Fluoroelastomer Blend (SPEC-01417-SC-X15111)	High Performance Elastomer Blend (SPEC-01417-SC-X15112)
Flexibility	Flexible	Flexible
Operating Temperature Range	-55°C to +150°C	-55°C to +135°C
Shrink Temperature (min.)	135°C	135°C
Tensile Strength (psi)	2200	1500
Elongation (% min.)	400	300
Heat Shock	4 hrs, 225°C	4 hrs, 220°C
Heat Aging	168 hrs, 150°C	168 hrs, 150°C
Dielectric Strength (V/mil)	200	200
Volume Resistivity (ohms-cm)	10 <sup>10</sup>	10 <sup>10</sup>
Water Absorption (%)	0.5	0.5
Flammability	Burn Time <120 sec Burn Length <25mm	Burn Time <120 sec Burn Length <25mm
RoHS Compliant	Yes	Yes

**Approval:**

Project Manager, Heavy Brigade Combat Team (PM-HBCT), US Army Tank-Automotive Command (TACOM)



For more information contact Glenair at 818-247-6000 or visit our website at [www.glenair.com](http://www.glenair.com) U.S. CAGE code 06324



COMPOSITE  
Piggyback boot backshell adapters



Partially recovered for quick and easy assembly

**310-048 ENVIRONMENTAL PIGGYBACK BOOT ADAPTER**

Pre-positioned and partially recovered shrink-boot/adaptor unit is ready for fast and reliable final recovery of the boot. Provides durable environmental sealing and strain-relief to the cable-to-backshell junction. Adapter is lightweight composite thermoplastic.



How To Order	
Sample Part Number	310 F S 048 XB 16 -2
Piggyback Boot Adapter	Environmental
Connector Designator	A = MIL-DTL-83723, Sr. III; MIL-DTL-5015; MIL-DTL-26482 F = MIL-DTL-38999, Sr. I & II H = MIL-DTL-38999, Sr. III & IV
Angular Function	S = Straight
Basic Number	
Finish	XB = no plating, black composite
Shell Size	08, 10, 12, 14, 16, 18, 20, 22, 24
Boot Material Type	1 = High-Performance Semi-Rigid Elastomer 2 = Zero-Halogen Semi-Rigid Polyolefin 3 = General Purpose Flexible Polyolefin

**317-102 EMI/RFI ENVIRONMENTAL PIGGYBACK BOOT ADAPTER WITH DROP-IN BANDING PORCH**

This Piggyback boot features a unique drop-in conductive banding porch. The pre-positioned and partially recovered shrink boot is ready for final recovery after the cable shield is band terminated to the drop-in accessory. Adapter is lightweight composite thermoplastic.



How To Order	
Sample Part Number	317 F S 102 XB 16 -2 K
Piggyback Boot Adapter	EMI/RFI Environmental with drop-in banding porch
Connector Designator	A = MIL-DTL-83723, Sr. III; MIL-DTL-5015; MIL-DTL-26482 F = MIL-DTL-38999, Sr. I & II H = MIL-DTL-38999, Sr. III & IV
Angular Function	S = Straight
Basic Number	
Finish	XB = electroless nickel XMT = Ni-PTFE, Nickel-Fluorocarbon Polymer XN = Selective plating, Nickel & Cad O.D.
Shell Size	08, 10, 12, 14, 16, 18, 20, 22, 24
Boot Material Type	1 = High-Performance Semi-Rigid Elastomer 2 = Zero-Halogen Semi-Rigid Polyolefin 3 = General Purpose Flexible Polyolefin
Pre-Coiled Band	K = Pre-Coiled Band, Omit if not required

**635-005 ENVIRONMENTAL PIGGYBACK BOOT CABLE FEED-THROUGH**

This composite feed-through is supplied with a pre-positioned and partially recovered shrink boot—ready for fast and reliable final recovery of the boot. Provides durable environmental sealing and strain-relief to the feed-through-to-box junction. Adapter is lightweight composite thermoplastic.



How To Order	
Sample Part Number	635 005 XB 01 -2 5
Piggyback Boot Adapter	Environmental Cable Feed-Through
Basic Number	
Finish	XB = no plating, black composite
Dash No.	01, 02, 03, 04, 05, 06, 07 (consult factory)
Boot Material Type	1 = High-Performance Semi-Rigid Elastomer 2 = Zero-Hal Semi-Rigid Polyolefin 3 = General Purpose Flexible Polyolefin
Length	in 1/8 inch increments, 5/8" minimum, e.g. 5 = .625 in.

COMPOSITE  
Piggyback boot backshell adapters



Partially recovered for quick and easy assembly

**319-183 EMI/RFI ENVIRONMENTAL PIGGYBACK BOOT ADAPTER WITH INTEGRATED SHIELD SOCK**



This integrated EMI/RFI shield sock, with its partially recovered shrink-boot and composite connector backshell delivers speed, convenience, and performance. Simply couple in place, terminate the supplied shield to the cable and complete the recovery of the boot.

How To Order	
Sample Part Number	319 H S 183 XM 19 B -2
Piggyback Boot Adapter	EMI/RFI Environmental with integrated shield sock
Connector Designator	A = MIL-DTL-83723, Series III; MIL-DTL-5015; MIL-DTL-26482 F = MIL-DTL-38999, Series I & II G = MIL-DTL-28840 H = MIL-DTL-38999, Series III & IV U = MIL-DTL-29600
Angular Function	S = Straight T = 45° Elbow W = 90° Elbow
Basic Number	
Finish	XM = Electroless Nickel XMT = Ni-PTFE, Nickel-Fluorocarbon Polymer XW = Cad/O.D. over electroless nickel
Shell Size	08, 10, 12, 14, 16, 18, 20, 22, 24
Optional Braid Material	A = 100% AmberStrand® B = 75%/25% AmberStrand® Blend - = Nickel-Copper 34AWG T = Tin/Copper 34AWG L = ArmorLite™
Boot Material Type	See Table IV

**443-033 EMI/RFI ENVIRONMENTAL BAND-IN-A-CAN PIGGYBACK BOOT AND COMPOSITE BACKSHELL**

This composite, two-piece band-in-a-can adapter comes equipped with a partially recovered shrink boot attached to the nut. After the cable shield is terminated to the band porch, simply screw the nut and boot into place and complete the boot recovery process.



How To Order	
Sample Part Number	443 H S 033 XM 19 20 K S -2
Piggyback Boot Adapter	EMI/RFI Environmental Band-in-a-Can boot/backshell
Connector Designator	A = MIL-DTL-83723, Series III; MIL-DTL-5015; MIL-DTL-26482 F = MIL-DTL-38999, Series I & II G = MIL-DTL-28840 H = MIL-DTL-38999, Series III & IV
Angular Function	S = Straight W = 90° Elbow
Basic Number	
Finish	XM = Electroless Nickel XMT = Ni-PTFE, Nickel-Fluorocarbon Polymer XW = Cad/O.D. over electroless nickel
Shell Size	08, 10, 12, 14, 16, 18, 20, 22, 24, 28
Entry Dia.	Codes 10–32 for diameters .236" – .394" after shrinkage, consult factory
Pre-Coiled Band	K = Pre-Coiled Band, Omit if not required
Slot Option	S = Pigtail Slot, Omit for none
Boot Material	See Table IV



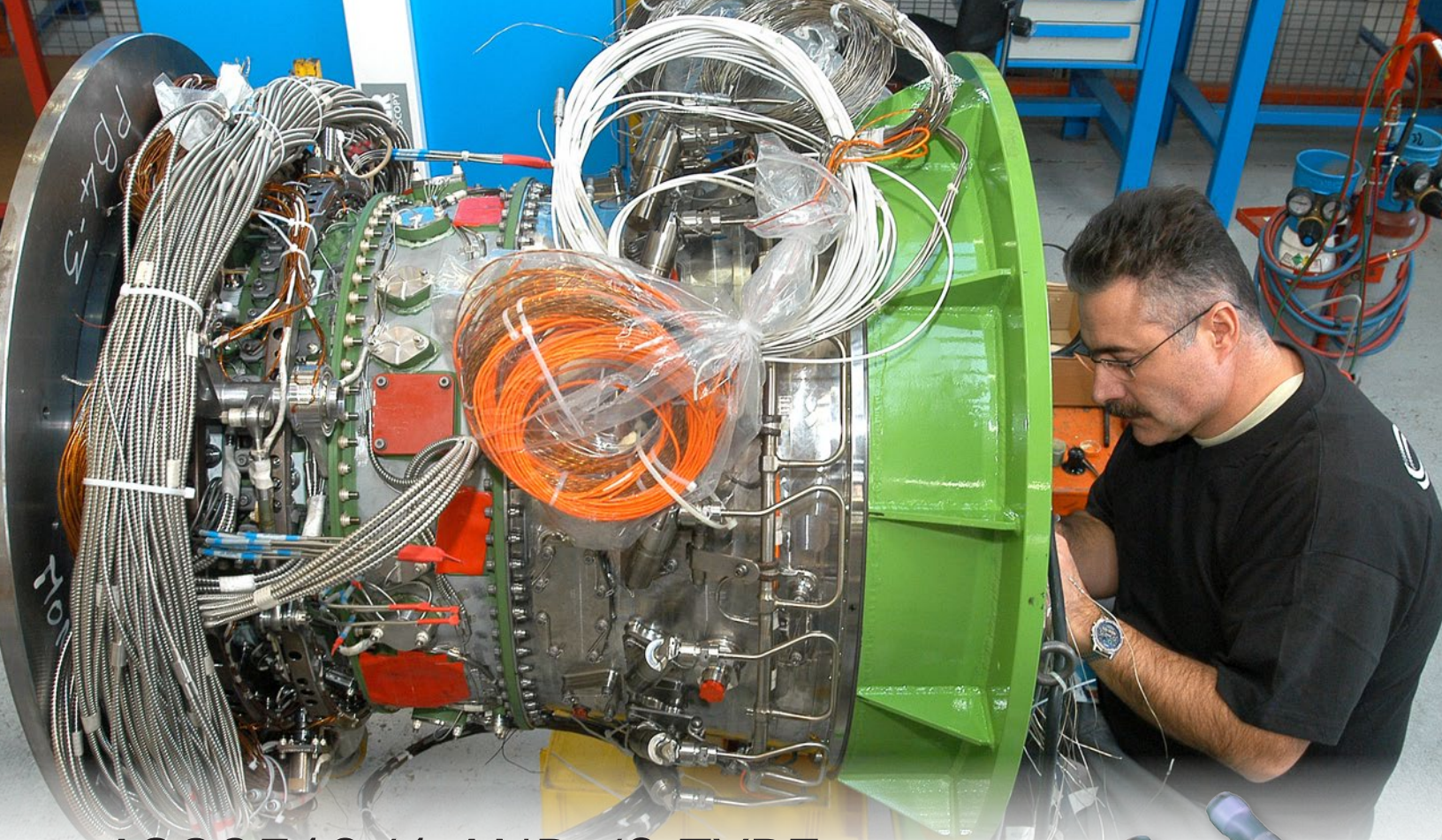

# AS83519/1 AND /2 TYPE Heat Shrink Termination (HST) Sleeves

For fast and reliable termination of EMI cable shielding to ground

Reliable termination of EMI/RFI shielding (to ground) in wire harness applications is universally accomplished with AS83519/1 and /2 type heat shrink termination (HST) sleeves. These devices, supplied in five different sizes—with or without pre-installed ground lead wires—provide environmental encapsulation and insulation of the shield termination site. Lead wire-equipped versions allow for easy and reliable grounding to connector shells, backshells, or ground posts. Transparent heat shrink tubing allows for easy inspection and supplies additional strength and strain-relief. The preflux solder preform delivers a fast and controlled solder joint each and every time.

- Heat shrink termination sleeves, with and without lead wire
- Ultra-fast recovery for reduced assembly time
- Pre-installed, pre-tinned braid version available
- Mil-qualified 81824/1 in-line-splices
- High availability: all Glenair HSTs made in USA and in-stock for immediate, same day shipment

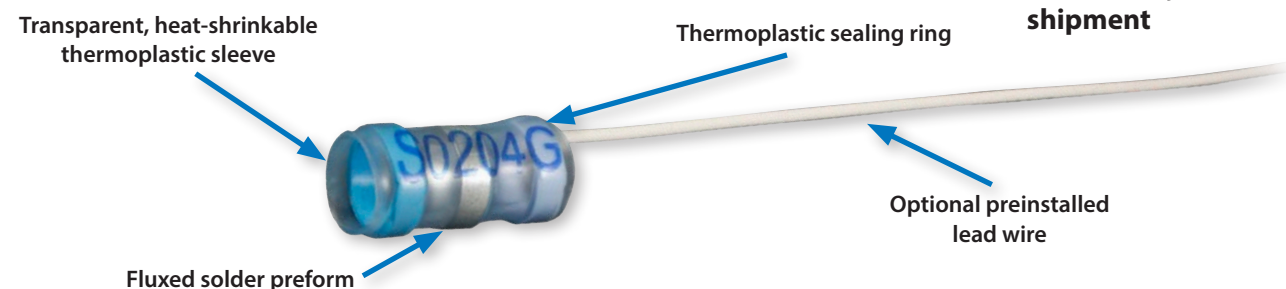

## AS83519 TYPE • 81824/1 QUALIFIED Heat Shrink Termination Sleeves and Mil-Qualified In-Line Splices



### AS83519/1 TYPE HEAT SHRINK TERMINATION (HST) SLEEVES, NO LEAD WIRE

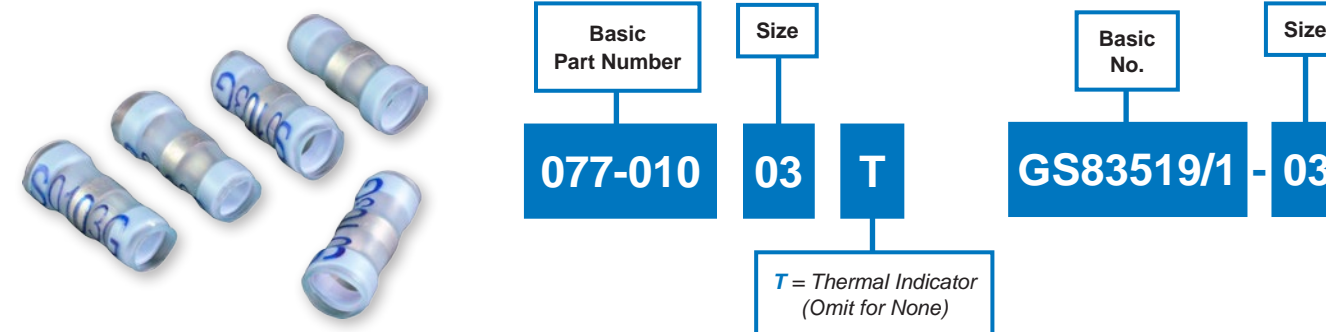

### AS83519/2 TYPE HEAT SHRINK TERMINATION (HST) SLEEVES, PRE-INSTALLED LEAD WIRE

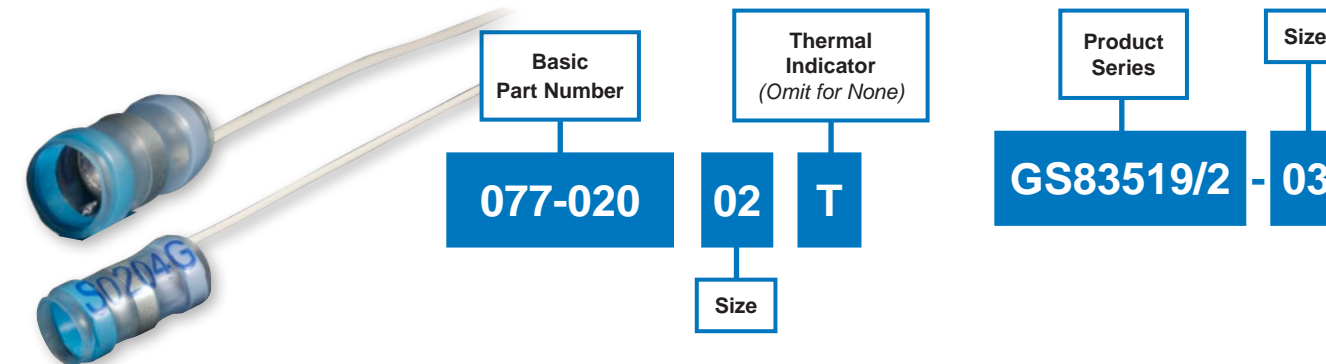

### AS83519/2 TYPE HEAT SHRINK TERMINATION (HST) SLEEVES, PRE-INSTALLED BRAID, PRE-TINNED ON BOTH ENDS

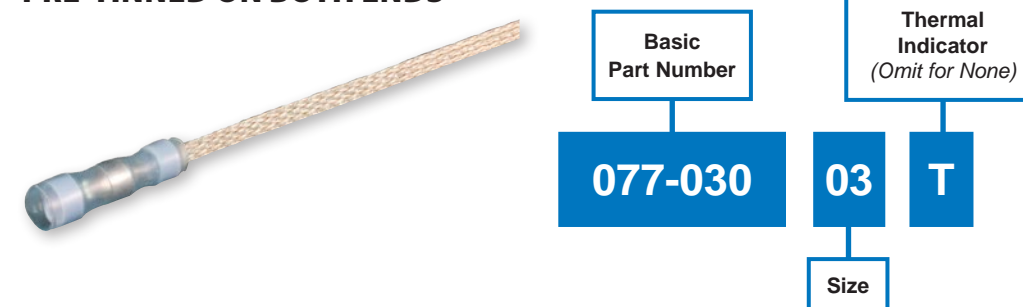

### MIL-QUALIFIED IN-LINE SPLICE

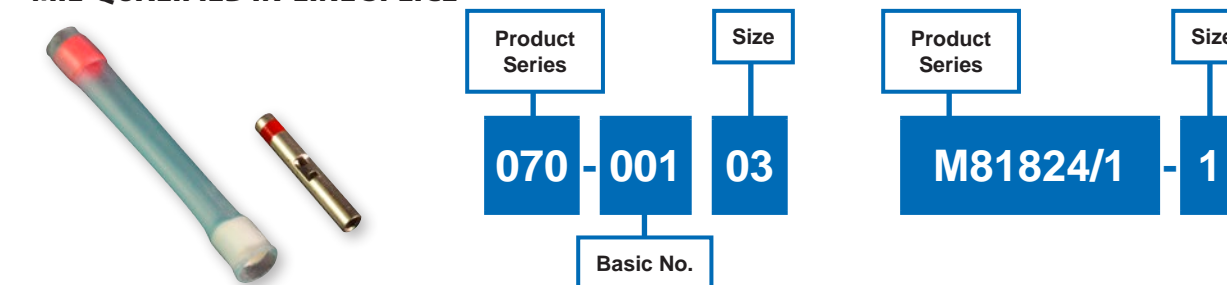



**DURALECTRIC™**  
High-performance jacketing material



Outstanding durability and insulation performance

**DURALECTRIC™**



Rugged high-temperature, environmental Duralectric™ jacketing is available in a broad range of and colors including safety orange

Duralectric™ is the high-performance jacketing material perfectly suited for immersion, chemical or caustic fluid exposure, temperature extremes, UV radiation and more

Glenair Duralectric™ weatherproof jacketing is halogen free, flame resistant, and functional to 260°C. Duralectric™ far surpasses the accelerated solar weathering standards under IEC 60068-2-5, and is tested to 56 accelerated days, equivalent to 53 years of solar exposure. Glenair can supply the material in a variety of formats, including blown jacketing, as an extrusion over wire and cable, as an overmolding compound and as a self-vulcanizing repair tape.

Jacketing Options		
0	Black	Weatherproof, halogen free, flame resistant, functional to 260°C
1	Desert Tan	Fed Std #33446 Desert Tan color
2	Red	Pantone® 1797 U
3	Orange	OSHA Safety Orange to mark energized electrical cables
4	Yellow	Pantone® Yellow U
5	Green	Pantone® 355 U
6	Blue	Pantone® 3005 U
7	Violet	Fed Std 595; #37100
8	Gray	Qualified to US Navy MIL-PRF-24758A, Fed Std 595B #26270 Haze Gray color
9	White	Fed Std 595; #37875

**Glenair Duralectric™ Material Specifications**

Temperature rating: -60°C to +260°C (with excursions to 290°C)  
 Halogen free per IEC 60614-1. Less than 5mg of hcl per 1 gm of product tested.  
 Accelerated Weathering (Solar) per IEC 60068-2-5; 56 days exposure  
 Flame Resistant per IEC 60614-1; Material does not sustain combustion when the source of flame is removed.  
 Low Smoke Index per NES 711 (11.75); Minimum standard is 25. The Glenair tested level is 11.75. This makes the material acceptable for interior applications as well as topside.  
 Smoke Density Class F1 Per NF F 16-101 IAW DIN EN 60695-2-11:2001  
 Toxicity Index per NES 713 (1.9); Minimum standard is 5. The Glenair tested level is 1.9. This makes the material acceptable for interior applications as well as topside.  
 Colorable to Fed Std 595B  
 Markable IAW MIL-PRF-24758A  
 Oxygen Limiting Index = 45.1 Per EN ISO 4589-2:1999; Minimum is 28.  
 ASTM E 595 vacuum outgassing—post bake results: TML .06%, CVCM .006%, WVR .02%  
 Fungus resistance testing (rating of 0) per MIL-STD-810F, method 508.5  
 ASTM D624 DIE B tear test: 150 KN/M

**12 Sec Vertical Burn: (Pass) Per 14CFR Part 25.853(a) amdt 25-116 App F Part 1 (a)(1)(ii)**

Fluids Per MIL STD 810F, Method 504	Cleaner (MIL-C-85570): CALLA-855
Fuel (MIL-T-83133): JPG	Solvent (Isopropyl Alcohol): TT-I-735
Fuel (MIL-T-83133): JPG	De Icer (AMS-1432): E36 Runway Deicer
Hydraulic Fluid (MIL H 5606): ROYCO 756	Coolant (MIL-C-87252): Coolanol 25R
Lube Oil (MIL-L-23699): ROYCO-500	Fire Extinguishant Foam: AMEREX AFFF

Jacketing Material Properties	
Material Property	Duralectric™
Temperature Range	-60°C to +260°C
Specific Gravity	1.22
Weight: Lbs./Cubic Inch	.045
Abrasion Resistance	Good
Wear Resistance	Good
Flame Resistance	Excellent
Sunlight Resistance	Excellent

Chemical Resistance	
Aliphatic Hydrocarbons	Excellent
Aromatic Hydrocarbons	Excellent
Ketones, Etc.	Excellent
Oil & Gasoline	Excellent

HIGH-PERFORMANCE  
Cable and conduit jacketing



Neoprene • Hypalon® • EPDM • Viton



- Extruded, blown-on and heat shrink jacketing for harsh application environments
- General purpose polyurethane
- Chemically-resistant Viton®
- Industry standard neoprene
- Selected materials CBRN tested

Cable and conduit jacketing materials purpose-designed for every application requirement: Immersion, chemical or caustic fluid exposure, temperature extremes, UV radiation and more



Jacketing Options		
N	Neoprene	Tough, durable polychloroprene for mechanical and environmental protection
H	Hypalon®	Light weight with broad temperature range
E	EPDM	Better resistance to Ketones
V	Viton®	Heaviest material with best resistance to oil and gasoline

**Jacketing Material Properties and Chemical Resistance**

Material Property	EPDM (Ethylene Propylene Diene Monomer)	Hypalon (Chlorosulfonated Polyethylene)	Neoprene (Polychloroprene)	Viton® (Fluoroelastomer)
Temperature Range	-60°F to +300°F (-51°C to +149°C)	-60°F to +300°F (-51°C to +149°C)	-60°F to +250°F (-51°C to +121°C)	-40°F to +392°F (-40°C to +200°C)
Specific Gravity	1.26	1.18	1.25	1.80
Weight: Lbs./Cubic Inch	.045	.043	.045	.055
Abrasion Resistance	Excellent	Excellent	Excellent	Excellent
Wear Resistance	Good	Good	Good	Good
Flame Resistance	Good	Good	Good	Good
Sunlight Resistance	Good	Excellent	Excellent	Excellent

**Chemical Resistance**

Aliphatic Hydrocarbons	Good	Good	Good	Excellent
Aromatic Hydrocarbons	Good	Fair	Fair	Excellent
Ketones, Etc.	Good	Poor	Poor	Poor
Oil & Gasoline	Good	Good	Good	Excellent

**MASTER Seal**  
SELF-VULCANIZING SEALING TAPE

**GLENAIR PART NO. 687-758**

Duralectric™ material sealing tape designed for temporary repair of cable and conduit. Glenair Master Seal effectively stops water incursion until a permanent repair can be made.



Composite metal-clad  
EMI/RFI braided shielding



AmberStrand® is ultra-lightweight microfilament metal clad EMI/RFI composite braiding

- Metal-clad EMI/RFI Shielding with a lightweight composite thermoplastic base material
- Highly conductive surface plating
- Reduce shielding weight up to 80% and more
- Reduce operation costs by permanently reducing launch and aircraft all-up weights
- Superior high frequency shielding compared to tinned and/or nickel plated copper
- Exceptional tensile strength: 590,000 psi (min)



AmberStrand®: The smart way to reduce launch and flight weights in aerospace systems

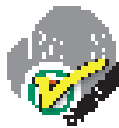

Composite strain-relief backshell with integrated AmberStrand® lightweight composite metal-clad braid shield sock.

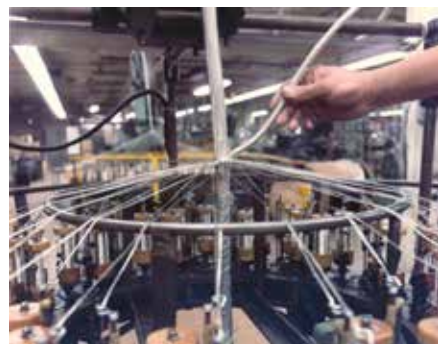
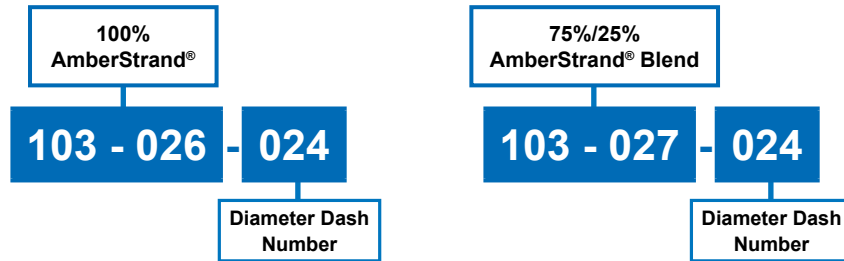

Glenair can also offer AmberStrand® users direct factory overbraiding services for both point-to-point as well as multi-branch interconnect assemblies.

Composite metal-clad  
EMI/RFI braided shielding

Aircraft Utilization Analysis

Comparison of AmberStrand® Composite EMI/RFI braid to 36 AWG A-A-59569 Ni/Cu Braid results in 60+ pounds weight savings in a typical commercial carrier

Where is all the EMI/RFI braid deployed in a typical commercial aircraft?									
Diameter (in)	L Wing	R Wing	Fwd Belly	Aft Belly	HYD Bay	Aft Barrel	Tail	V/H Stab	Totals (in)
0 - 0.25	1852.2	1852.2	0	2811.4	168.2	2015.2	2480.6	1385	12564.8
0.25 - 0.5	434.8	434.8	511.6	1034.6	257.4	506.2	958.2	1121.7	5259.3
0.5 - 0.75	0	0	260.9	223	0	184.2	392.4	152.1	1212.6
0.75 - 1.0	0	0	77.2	0	0	1198	162.2	0	1437.4
1.0 - 1.5	0	0	0	0	0	446	21	0	467

How much would all this braid weigh if it was made of 36 AWG A-A-59569 NiCu?			
Diameter (in)	Weight (Lb/ft)	Length (in)	Weight (Lb)
0 - 0.25	0.02	12564.8	21.08
0.25 - 0.5	0.05	5259.3	21.17
0.5 - 0.75	0.07	1212.6	7.12
0.75 - 1.0	0.14	1437.4	16.88
1.0 - 1.5	0.18	467	7.05
Total weight			73.30 lbs

How much would all this braid weigh if it was made of lightweight composite AmberStrand®?			
Diameter (in)	Weight (Lb/ft)	Length (in)	Weight (Lb)
0 - 0.25	0.003	12564.8	4.16
0.25 - 0.5	0.008	5259.3	3.58
0.5 - 0.75	0.011	1212.6	1.16
0.75 - 1.0	0.018	1437.4	2.11
1.0 - 1.5	0.034	467	1.30
Total weight			12.31 lbs

Expressed in percentages, how does 100% and 75% metal clad AmberStrand® compare against tin-coated copper?						
Braid Diameter	AmberStrand® 100% 103-026	Tinned Copper 100-001	% Weight Savings/Foot	AmberStrand® 75/25% NiCu 103-027	Tinned Copper 100-001	% Weight Savings/Foot
.062	.6	1.9	68%	.9	1.9	52%
.125	1.0	4.8	79%	1.5	4.8	68%
.250	1.8	16.1	88%	2.4	16.1	85%
.375	2.3	18.5	87%	3.9	18.5	79%
.500	3.7	22.3	83%	5.4	22.3	76%
.625	4.4	27.7	84%	6.4	27.7	77%
.750	5.2	34.3	85%	7.2	34.3	79%
1.000	8.0	35.0	77%	11.0	35.0	69%

How does AmberStrand® compare, in terms of mechanical performance, to other materials?											
Material Type	AmberStrand® Thermoplastic	PEEK (Monofil)	Fluoropolymer (Yarn)	Kevlar (Yarn)	Dacron (Yarn)	Halar (Monofil)	Fluoropolymer FEP (Monofil)	Nomex (Yarn)	Polyester Type FR (Monofil)	Ryton Type R-7 (Monofil)	PTFE-Glass (Yarn)
Glenair P/N	103-026 103-027	102-051	102-061	102-071	102-073	102-023	102-060	103-013	102-001 102-002	102-080	100-022
Temperature Range	-65°C to +200°C	-65°C to +260°C	-55°C to +200°C	-73°C to +175°C	-62°C to +150°C	-65°C to +200°C	-55°C to +260°C	-55°C to +125°C	-55°C to +200°C	-65°C to +200°C	-75°C to +525°C
Tensile Strength (PSI) Yield	590,000	780,000	40,000	400,000	160,000	35,000	14,000	90,000	50,000	19,000	450,000
Elongation Percentage	2.5%	38%	19%	3.6%	12%	15%	50%	25%	20%	35%	5%
Chemical Resistance	Excellent	Excellent	Excellent	Excellent	Good	Excellent	Excellent	Excellent	Good	Excellent	Excellent
Abrasion Resistance	Good	Excellent	Good	Good	Excellent	Excellent	Good	Good	Good	Excellent	Excellent
Specific Gravity	1.45	1.30	2.10	1.44	1.38	1.68	2.17	1.58	1.38	1.25	2.50
Flammability	Will Not Burn	Very Low	Will Not Burn	Will Not Melt	Flammable	Flammable	Very Low	Will Not Melt	Very Low	Very Low	Will Not Burn







INDUSTRY-STANDARD  
EMI/RFI metal braided shielding  
and fabric braided sleeving



- Complete range of QQ-B-575B/A-A and ASTM B conductive braided shielding solutions
- Tubular, tapered tubular, and overbraided application options
- Every size from 1/32" to 3/4"
- High performance tubular fabric braided sleeving for every mechanical and wire-protection application requirement



World's largest selection of metal and fabric cable shields

100-001 TUBULAR METAL BRAID QQ-B-575B/A-A-59569 ASTM B298 TIN COATED COPPER



How To Order				
Sample Part Number	100-001	A	XXX	L
Tubular Metal Braid	Tin Coated Copper Braid			
Wire Gauge	A = 36 AWG B = 34 AWG			
Size	Consult Factory			
Lanyard Option	L = Lanyard Omit for none			

100-002 TUBULAR METAL BRAID QQ-B-575B/A-A-59569 ASTM B298 SILVER COATED COPPER



How To Order				
Sample Part Number	100-002	A	XXX	L
Tubular Metal Braid	Silver Coated Copper Braid			
Wire Gauge	A = 36 AWG B = 34 AWG			
Size	Consult Factory			
Lanyard Option	L = Lanyard Omit for none			

100-003 TUBULAR METAL BRAID ASTM B355 CLASS 4 OFHC NICKEL PLATED COPPER



How To Order				
Sample Part Number	100-003	A	XXX	L
Tubular Metal Braid	Nickel Plated Copper Braid			
Wire Gauge	A = 36 AWG B = 34 AWG			
Size	Consult Factory			
Lanyard Option	L = Lanyard Omit for none			

100-041 TAPERED TUBULAR METAL BRAID

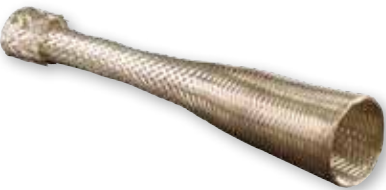

How To Order					
Sample Part Number	100-041	-06	T	10	A
Tubular Metal Braid	Tapered Braid				
Dash No.	Diameters .15 - 1.38, Consult Factory				
Material	A = 100% AmberStrand <sup>®</sup> N = Nickel/Copper B = 75%/25% AmberStrand <sup>®</sup> S = Silver/Copper L = 100% ArmorLite <sup>™</sup> T = Tin/Copper				
Length	In 1 inch increments				
Wire Gauge	A = 36 AWG, Omit for std. 34 AWG (applies to N, S, T materials only).				

INDUSTRY-STANDARD  
EMI/RFI metal braided shielding  
and fabric braided sleeving



FABRIC BRAIDED SLEEVING FOR NON-ENVIRONMENTAL WIRE AND CABLE PROTECTION



Non-Environmental Fabric Braided Sleeving Types	
Series No.	Type
100-022	PTFE glass tubular braided sleeving
102-001 and -002	Polyethylene expandable fabric tubular braided sleeving; black, green, red, white, and yellow
102-020, -021, -022 and -023	Halar expandable fabric tubular braided sleeving, white or black, with and without tracers
102-073	Dacron tubular braid, black
103-013	Nomex tubular braid; black, white, red, green, gray, and desert tan
102-051	PEEK tubular braid, black
102-061	Fluoropolymer tubular braid, clear and natural
102-071	Kevlar tubular braid, natural
102-072	Nylon tubular braid, black

SERIES 100-022 HIGH-TEMPERATURE PTFE-GLASS TUBULAR BRAIDED SLEEVING



Highly flexible PTFE-glass tubular braided sleeving with outstanding high- and low-temperature resistance (-240°C to +525°C)

How To Order			
Sample Part Number	100-022	XXX	GN
Tubular Metal Braid	PTFE-Glass Braided Sleeving		
Size	Consult Factory		
Color Option	GN = Green/Olive Drab (Omit for Natural)		

FACTORY OVERBRAIDING SERVICES FOR MULTI-BRANCH CABLE ASSEMBLIES



Glenair operates its own high-capacity multi-spindle overbraiding operation







# MIL-DTL-24749 REV B TYPE IV Stainless Steel/Nickel Ground Straps



## MIL-DTL-24749 TYPE IV Ground Straps for Navy shipboard applications

Ground straps utilized in shipboard applications are subject to grueling environmental conditions: wet, cold, salt water spray, and caustic hydraulic fluids. Conventional copper braid/copper lug ground straps corrode, and become a source of electrical resistance problems in these harsh environments.

Glenair MIL-DTL-24749 Rev B Type IV ground straps solve these corrosion and electrical resistance problems with a unique 50% Stainless Steel 316L / 50% Nickel 200 36AWG blend braid, and passivated Stainless Steel lugs. These US Navy-approved ground straps are qualified to the rigorous standards of M24749, and are tested beyond the mil-spec to survive 1000 hours salt spray. Allowed usages for Type IV straps can be found in MIL-STD-1310H.



**Glenair MIL-DTL-24749 Rev. B Type IV Stainless Steel/Nickel Ground Straps: US Navy qualified and tested to survive extreme environments**

- Meets the rigorous specifications of MIL-DTL-24749 Rev. B
- Tested to survive 1000 hours salt spray
- Unique Stainless Steel/Nickel hybrid braid
- Available in six standard configurations, with non-standard length/lug size configurations available



For more information contact Glenair at **818-247-6000** or visit our website at **www.glenair.com**  
U.S. CAGE code 06324



How To Order					
Sample Part Number	MS24749	-IV	-B	-L	-H
Product Series	MIL-DTL-24749 Rev. B Type IV bond strap				
Bond Strap Type	IV = Flat CRES 316 / Nickel 200 braid with mounting lugs				
Standard Size Code	A = 6.0" length; .90" width, .406 H dia.    D = 6.0" length; .90" width, .282 H dia. B = 12.0" length, .90" width, .406 H dia.    E = 12.0" length, .90" width, .282 H dia. C = 18.0" length, .90" width, .406 H dia.    F = 18.0" length, .90" width, .282 H dia. N = for non-standard sizes				
Non-Standard Length	Non-Standard length in inches (omit for standard sizes)				
Hole Diameter	Non-Standard diameter in inches (omit for standard sizes)				

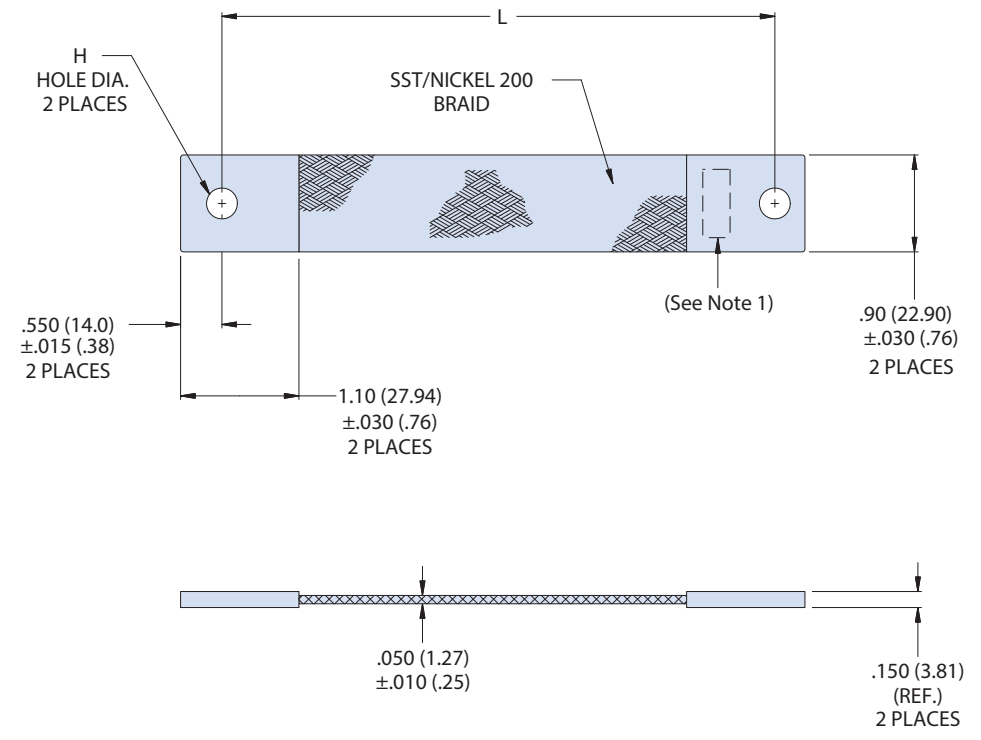

- NOTES**
1. Lugs are ink stamped or electro-etched per M24749 Rev B. Minimum character height shall be .06 (1.52)
  2. Metric dimensions (mm) indicated in parentheses
  3. Codes A – F are standard lengths. To order non-standard straps, omit Standard Size Code and enter length (in inches) in part number.

**MATERIAL/FINISH**  
Lugs - 316L Stainless Steel/Passivate  
Braid - 316L Stainless Steel 36 AWG, 50%; 200 Nickel 36 AWG, 50%







# LIGHT-DUTY, LOW PROFILE ArmorLite™ Single-Layer ESD Grounding Strap

107-098



## LIGHTWEIGHT

## ArmorLite™ Microfilament Ground Straps—for Aircraft ESD, Lightning Strike and Other Applications

Lightning interaction mechanisms and protection techniques are well known disciplines in aircraft design. But innovations are still required, particularly in support of efforts to reduce the size, weight and assembly complexity of aircraft electrical systems. Lightweight Glenair technologies for spot grounding are broadly utilized for:

- Grounding airframe sections
- Dissipating static build-up in composite structures
- Dissipating lightning strike energy
- Grounding individual moving parts in complex equipment such as landing gear

ArmorLite™ microfilament braid offers 70+% weight savings over standard NiCu braid—plus advantages in virtually every category due to Glenair's ability to fine-tune the makeup of the material cross-section (core, cladding and protective plating) to the exact requirements of each application. Glenair ArmorLite™ lightweight microfilament braids, and hybrid ArmorLite™ and nickel braids are now approved for use by every major airframe and equipment manufacturer.



### GLENAIR BONDING ENGINEERS ARE EXPERTS IN GROUND STRAP OPTIMIZATION FOR:

- Weight and conductivity
  - Electrical resistance and high operating temperature (200°C)
  - Rapid heat distribution
  - Bend cycle durability up to 250,000 cycles per EN4199-001
  - Material aging and corrosion resistance
- Comprehensive test reports available

### CUSTOM CONFIGURATIONS AVAILABLE



Hybrid Materials



Bent Lugs



Heavy Duty

### LOW-PROFILE ESD GROUNDING STRAPS, LIGHT AND MEDIUM DUTY



How To Order				
Sample Part Number	107-098	-A	-12	-6
Grounding Strap	-098 = Single layer light duty ArmorLite -099 = Dual layer medium duty ArmorLite			
Material	A = ArmorLite microfilament stainless steel braid			
Width Code	(See Table II)			
Length	Dimension (L) in one inch increment			

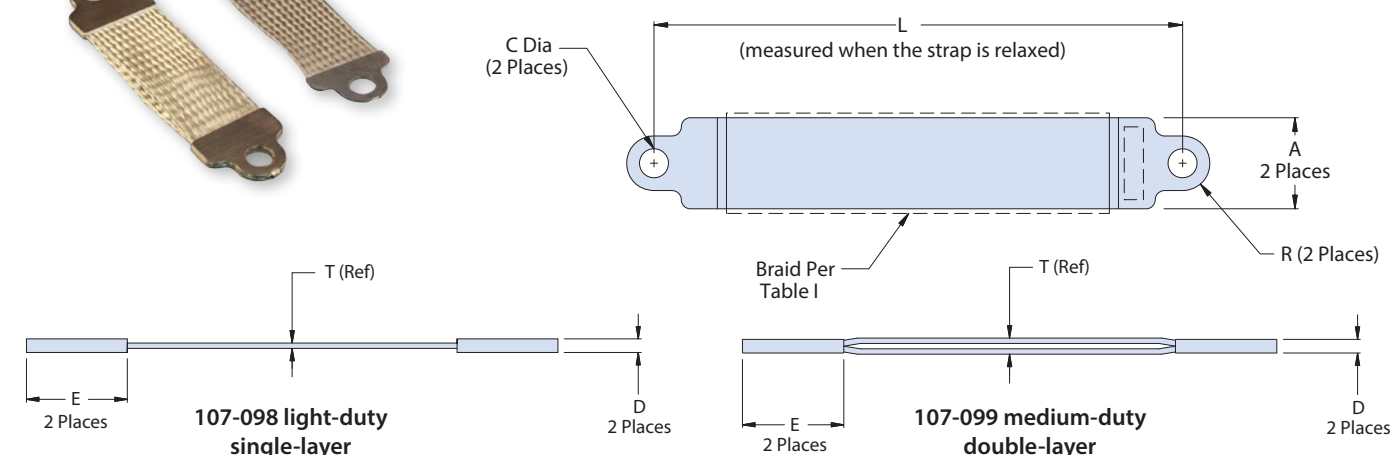

Table II: Mechanical/Electrical Parameters for ArmorLite Material												
Width Code	A ± .03	C	R	D	E	T	Nom. Resistance mOhm/m* (AWG Equiv.)	Lug Junction Resistance mOhm	Weight gr/m*	Inductance nH/m (Ref. Only)	Test Current Amps**	Tensile Strength Lbf
12	.290 (7.37)	.150 (3.81)	.145 (3.68)	.042 (1.06)	.480 (12.19)	.016 (.41)	48 (22)	0.129	9.0	1277	37	130
20	.480 (12.19)	.200 (5.08)	.240 (6.10)	.042 (1.06)	.690 (17.53)	.016 (.41)	26 (19)	0.111	13.4	1170	52	216
24	.590 (14.99)	.260 (6.60)	.295 (7.49)	.042 (1.06)	.790 (20.06)	.016 (.41)	23 (18)	0.097	17.9	1116	62	219
32	.820 (2.83)	.390 (9.91)	.375 (9.53)	.052 (1.32)	.950 (24.13)	.021 (.53)	13 (16)	0.089	35.8	1047	127	483
40	.870 (22.10)	.390 (9.91)	.375 (9.53)	.052 (1.32)	.950 (24.13)	.021 (.53)	11 (15)	0.061	40.3	1034	141	524
48	1.080 (27.43)	.390 (9.91)	.375 (9.53)	.052 (1.32)	.950 (24.13)	.021 (.53)	8 (14)	0.054	53.8	983	162	590
64	1.330 (33.78)	.390 (9.91)	.375 (9.53)	.052 (1.32)	.950 (24.13)	.021 (.53)	6 (12)	0.047	71.7	936	208	723
for 107-098 double-layer straps												
48	1.080 (27.43)	.390 (9.91)	.375 (9.53)	.080 (2.03)	1.15 (29.21)	.042 (1.06)	4 (11)	0.054	107.6	976	500	590
64	1.330 (33.78)	.390 (9.91)	.375 (9.53)	.080 (2.03)	1.15 (29.21)	.042 (1.06)	3 (10)	0.047	143.4	930	650	723

\*Braid only, figures exclude termination lugs. \*\*Test current is defined as the current required to reach 200° C at ambient temperature

### GROUND CONTROL EARTH BOND SYSTEM



How To Order	
600-120	Hydraulic Setting Tool for 1/4" Earth Bonds
600-123	Hydraulic Setting Tool for 3/8" Earth Bonds
600-124	Hydraulic Setting Tool for M6 Earth Bonds
600-125	Hydraulic Setting Tool for M10 Earth Bonds

The tools feature one hand operation and ram retract mechanism actuated by release trigger. Consult factory for control gauges and earth bond part numbers for each material type and size.



SERIES 72, 74, AND 75

# Metal and Polymer Core Conduit Systems

The flexible, lightweight alternative to standard jacketed cables

Metal and Polymer Core Conduit Product Families



Series 72 Annular Polymer Core Conduit Systems

Series 74 Helical Polymer Core Conduit Systems



Series 75 Metal-Core Conduit Systems

MIL-PRF-24758/Special-Purpose Conduit Systems



Conduit systems are ideally suited when wire protection requirements do not allow the specification of standard jacketed and shielded cabling. Jet aircraft landing gear applications, for example, require greater flexibility and mechanical protection against impact damage than is possible to provide in even the most aggressively armored cables. Glenair metal-core and polymer-core conduit systems provide superior wire protection, electromagnetic compatibility, flexibility, and ease-of-installation and maintenance compared to standard jacketed cables. Choose from turnkey factory-terminated systems or convenient user-installable fittings and materials.



For more information contact Glenair at **818-247-6000** or visit our website at **www.glenair.com**  
U.S. CAGE code 06324





Standard Black and Natural/Clear Annular Tubing

Blue, Yellow, Red, Desert Tan, and Orange Annular Polymer-Core Tubing

- **Lightweight, flexible polymer-core materials and easy to install fittings, transitions and adapters**
- **Choice of three tubing material choices: Kynar, PVDF and G-FLEX Siltem**
- **A wide range of colors including desert tan**
- **Choice of turnkey, factory-terminated assemblies or user-installable configurations**
- **All popular part numbers in stock and ready for same-day shipment**

High-performance annular convoluted tubing provides an economical, lightweight and durable enclosure for interconnect wiring

Part Number  
120-144



**For non-environmental and non-EMI/RFI applications**

Strong, abrasion resistant annular conduit tubing, supplied in thermally stabilized Kynar®, PVDF, or medium duty Siltem. Available in 7 colors, standard or slit.

Part Number  
121-190



**For non-environmental EMI/RFI applications**

Annular conduit tubing with braided shield for EMI/RFI protection and additional structural integrity, particularly pull (tensile) strength.

Part Number  
121-191



**For environmental EMI/RFI applications**

Annular conduit tubing with braided shielding for EMI/RFI protection and a ruggedized jacket for environmental protection against dust, dirt, and moisture incursion.

Part Number  
121-192



**For non-environmental EMI/RFI applications with high dB shielding requirements**

Annular conduit tubing with double braided shield for high frequency EMI/RFI protection and mechanical strength.

Part Number  
121-193



**For environmental EMI/RFI applications with high dB shielding requirements**

Annular conduit tubing with double braided shield and jacket for optimum EMI/RFI protection, strength and environmental sealing.

Tubing Material Choices		
Y	Kynar®	Flexible, thermally stabilized, resistant to harsh chemicals and radiation. UV resistant, self-extinguishing, nontoxic and resistant to low-temperatures. 166° C temp. rating.
V	PVDF	Flexible and chemical/radiation resistant. Available in 4 colors plus standard black and natural. 150° C temperature rating.
S	G-FLEX Siltem	Lightweight, halogen-free, low toxicity, low smoke. Exceptional flexibility and crush resistance. 175°C temperature rating. Ideal for harsh environment applications.

Material Properties - Kynar® and PVDF				
Material Property	Service Temperature	Tensile Strength	Elongation	Specific Gravity
Kynar® and PVDF	-65°F/330°F (-54°C/166°C)*	5000 PSI (34,474 KP)	250%	1.8 Max
Material Property	Heat Aging	Dielectric Strength	Volume Resistivity	Water Absorption
Kynar® and PVDF	168 Hrs. @ 347°F (175°C)	10,000V	10 <sup>16</sup>	0.02%
Material Property	Solvent Resistance	Flammability	Fungus Resistance	
Kynar® and PVDF	No swelling, stickiness or weight change	Non-burning	Does not support fungus growth	

\*Note: Kynar® and PVDF material properties are identical, with the exception that Kynar® has been irradiated for thermal stability, and thus has a higher temperature rating of 166°C compared to 150°C for non-thermally-stabilized PVDF.

G-FLEX Siltem is Glenair's proprietary annular polymer-core convoluted tubing formulation, developed for harsh environment applications that require a lightweight, halogen-free material with exceptional flexibility and crush resistance

Material Properties - G-FLEX Siltem				
Material Property	Flexural Modulus	Flexural Strength	Tensile Strength	Elongation
	168,000 PSI	5590 PSI	5700 PSI	60%
	Melt Flow Rate	Dielectric Strength	Volume Resistivity	Water Absorption
	38.0 G/10 min	422.9 V/mil	>1.E+16 Ohm-cm	0.58%

SERIES 72 CONVOLUTED TUBING PRODUCT SELECTION GUIDE







Seven standard tubing configurations, with and without braided shielding and jacketing

- Lightweight, flexible helical polymer-core materials and easy to install fittings, transitions and adapters
- ETFE, FEP, PFA, PTFE, and PEEK plus AS81914 /1 – 11 qualified materials and configurations
- Choice of turnkey, factory-terminated assemblies or user-installable configurations
- All popular part numbers in stock and ready for same-day shipment

## AS81914 qualified Series 74 high-performance helical convoluted tubing, backshells, fittings and assemblies

 <p><b>Part Number 120-100</b></p>	<p><b>Outstanding mechanical wire protection and lubricity for non-environmental and non-EMI/RFI applications</b></p> <p>Helical plastic convoluted tubing, available in a choice of 5 materials. Choose standard black or clear color.</p>
 <p><b>Part Number 121-101</b></p>	<p><b>Adds EMI/RFI braided shielding for use in non-environmental applications</b></p> <p>Helical plastic convoluted tubing, available in a choice of 5 materials, with a single braided shield for EMI/RFI protection.</p>
 <p><b>Part Number 121-102</b></p>	<p><b>Adds a second layer of high dB EMI/RFI shielding for use in non-environmental applications</b></p> <p>Helical plastic convoluted tubing, available in a choice of 5 materials, with double braided shield for high frequency shielding applications.</p>
 <p><b>Part Number 121-100</b></p>	<p><b>A jacketed configuration with one EMI/RFI shield for use in environmental applications</b></p> <p>Helical plastic convoluted tubing, available in a choice of 5 materials, with braided shielding for EMI/RFI protection and a ruggedized jacket for environmental protection.</p>
 <p><b>Part Number 121-103</b></p>	<p><b>Double-braided and jacketed configuration for environmental and high dB EMI/RFI shielding protection</b></p> <p>Helical plastic convoluted tubing, available in a choice of 5 materials with double shielding and jacket for optimum EMI/RFI protection and environmental sealing.</p>
 <p><b>Part Number 123-100</b></p>	<p><b>For environmental applications without EMI shielding requirements</b></p> <p>Helical convoluted tubing in choice of 5 materials with a ruggedized jacket for environmental protection.</p>
 <p><b>Part Number 121-195</b></p>	<p><b>Internal braid configuration for harsh chemical environment applications, with EMI/RFI shielding</b></p> <p>Chemical- and UV-resistant plastic conduit tubing with internal braid for weight savings and harsh-environment EMI/RFI protection.</p>

Series 74 Convoluted Tubing Material Choices		
E	ETFE (fluoropolymer) (Series 74 standard)	Highest tensile strength and lubricity. Combines mechanical toughness with outstanding chemical, dielectric and thermal properties, improved radiation resistance. This is our standard material for a reason: ETFE delivers the best performance and best value in high-performance polymer resins.
F	FEP	Economical with relatively high thermal stability, excellent dielectric properties. Unaffected by virtually all solvents and chemicals, good adhesion resistance.
P	PFA (Fluoropolymer)	Outstanding lubricity and resistance to corrosives, -95°F to 500°F temperature rating. Melt-extruded for better cold flow and long-term sealing than PTFE; more economical.
T	PTFE (Fluoropolymer)	Outstanding resistance to corrosives, -95°F to 500°F temperature rating. Somewhat better folding endurance than PFA. However, this paste-extruded Fluoropolymer® material is more difficult to process and so costs more than PFA with virtually equal performance.
K	PEEK	Low-smoke, zero-halogen with high strength and superior crush resistance. Lightest weight of all the tubing polymers, but also the highest material cost.

Series 74 Convoluted Tubing Material Properties					
Material Property	Perfluoroalkoxy (PFA)	Fluorinated Ethylene Propylene (FEP)	Ethylene Tetrafluoroethylene (ETFE)	Polytetrafluoroethylene (PTFE)	Polyether Ketone (PEEK)
Service Temperature	-95°F/500°F (-71°C/260°C)	-95°F/400°F (-71°C/204°C)	-65°F/310°F (-54°C/154°C)	-95°F/500°F (-71°C/260°C)	-76°F/392°F (-60°C/200°C)
Tensile Strength	3,000 PSI (20,684 KP)	2,500 PSI (17,237 KP)	5,000 PSI (34,474 KP)	2,500 PSI (17,237 KP)	7,000 PSI (48,300 KP)
Elongation	250%	200%	100%	175%	100%
Specific Gravity	2.15	2.15	1.70	2.15	1.26
Heat Aging	2000 Hrs.@ 525°F (274°C)	2000 Hrs.@ 430°F (221°C)	2000 Hrs.@ 350°F (177°C)	2000 Hrs.@ 525°F (274°C)	2,000 Hrs.@ 464°F (240°C)
Dielectric Strength	12,000V	12,000V	12,000V	12,000V	12,000V
Volume Resistivity	1018	1018	1016	1018	1016
Water Absorption	0.03%	0.01%	0.02%	0.01%	0.03%
Solvent Resistance	No swelling, stickiness or weight change				
Flammability	Non-burning				
Fungus Resistance	Does not support fungus growth				

### SERIES 74 CONVOLUTED TUBING PRODUCT SELECTION GUIDE

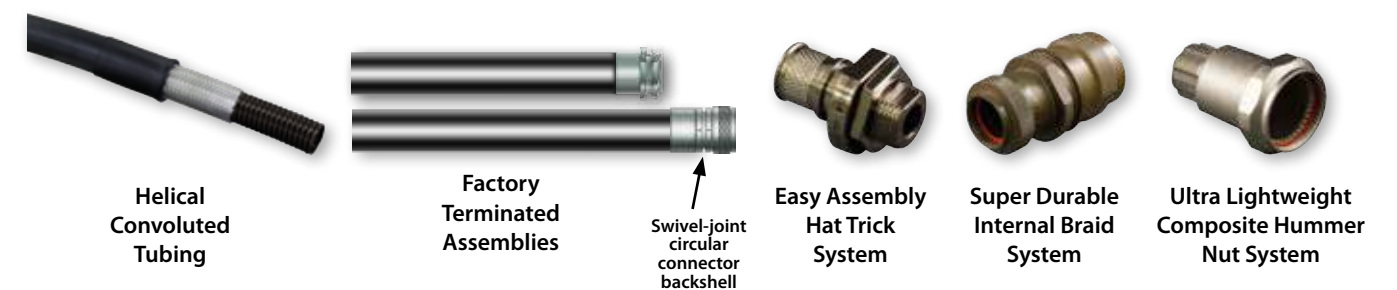





Copper-clad nickel iron conduit

- Hermetically sealed, flexible metal-core conduit for interconnect applications
- Choice of three materials: Brass, Stainless Steel, and Nickel Iron Alloy
- Turnkey, factory-terminated assemblies for landing gear and other rugged aerospace applications
- All materials deliver superior EMC performance as well as crush resistance and environmental sealing

The ultimate in highly flexible, crush-proof EMI/EMP protection:  
Series 75 helically-wound metal-core conduit

Part Number  
750-190

**Superior EMI protection and crush-proof strength for static applications**

Highly flexible crush-proof metal conduit, available in Nickel-Iron, Brass, or SST.

Part Number  
750-191

**Adds braided shielding for additional tensile strength applications**

Flexible metal-core conduit tubing with numerous braided shielding options, for additional tensile strength and effective grounding of electromagnetic interference.

Part Number  
750-192

**Adds a jacket for environmental protection**

Flexible metal-core conduit tubing with braided shielding plus a ruggedized jacket for environmental protection against contaminants and moisture.

Part Number  
750-193

**Adds a second braided shield for high dB EMI/RFI shielding**

Flexible metal-core conduit tubing with double braided shield for high frequency EMI/RFI shielding requirements.

Part Number  
750-194

**A jacketed, double-braided configuration for combined environmental and EMI/RFI applications with high dB shielding requirements**

Flexible metal-core conduit tubing with double braided shield and jacket for optimum EMI/RFI protection, strength and environmental sealing.

Part Number  
750-195

**Triple-braided conduit for predictable and reliable grounding of surface-borne/high frequency electromagnetic interference**

Flexible metal-core conduit tubing with triple braided shield for optimal tensile strength and enhanced high frequency EMI/RFI protection.

Part Number  
750-196

**Triple-braided and jacketed conduit for maximum EMI shielding in environmental applications**

Flexible metal-core conduit tubing with triple braided shield and jacket for enhanced high-frequency EMI/RFI protection, strength and environmental sealing.

Conduit Material Choices, Material Properties, and Military Specifications			
Glenair Code	Material	Properties	Applicable Military Specifications
B	Brass, Per A-A-52440 Type I, Grade B	Optimal EMI shielding when combined with bronze overbraid. Generally specified with bronze overbraid and jacket.	<ul style="list-style-type: none"> <li>IAW A-A-52440 (Covering shielded, electrical, flexible, metal conduit for use as protection of wiring in military vehicles from mechanical injury and, when properly installed and grounded, to prevent radiation that may cause interference with radio and other electronic equipment.)</li> </ul>
C	Stainless Steel AISI 316	Specified for high-temperature, corrosion, and crush resistance. Nominal shielding value. Typically braided with stainless steel braid for additional pull strength and durability. Available with or without a jacket.	<ul style="list-style-type: none"> <li>MIL-C-13909 (Superseded by IAW-A-A-52440 above)</li> <li>MIL-PRF-24758 (Covering the performance requirements for weatherproof flexible conduit systems for use primarily in exposed areas on U.S. Navy ships, to shield against electromagnetic (EM) radiation from own-ship transmitters and emissions external to the ship, electromagnetic pulse (EMP) events, and to minimize corrosion while being field repairable to reduce maintenance.)</li> </ul>
N	Nickel Iron Alloy Type 4 ANSI/ASTM-A-753	80% Nickel, 20% Iron. Optimal low-frequency shielding material. Typically braided with stainless steel braid for additional pull strength and durability. Available with or without a jacket.	<ul style="list-style-type: none"> <li>MIL-DTL-28840 (Covering Connectors, Electrical, Circular, Threaded, High Shock, High Density, Shipboard, Metal Conduit, for EMI Shielding)</li> </ul>

EMI/RFI Braided Shielding and Non-Metallic (Fabric) Overbraids		
B	Bronze	Standard for for brass core conduit
T	Tin/Copper	150°C temperature rating, 125 lbs. tensile strength, 96 hr. salt spray corrosion resistance
C	Stainless Steel	Highest tensile strength (225 lbs.), highest temperature—1093°C+
N	Nickel/Copper	200°C temperature rated, 150 lbs. tensile strength, 500 hrs. salt spray corrosion resistance
S	SnCuFe	Tin plated iron/copper
L	ArmorLite™	Microfilament metal-clad ultra lightweight stainless steel braid
D	Dacron	Yarn with excellent abrasion resistance, good chemical resistance, non-conductive
M	Nomex	-55°C to 260°C temperature range - will not melt, excellent chemical resistance, non-conductive
E	AmberStrand® 100%	Expandable, flexible, high-strength conductive metal-clad composite thermoplastic
F	AmberStrand® 75%/25%	75% Expandable, flexible, high-strength conductive metal-clad composite thermoplastic combined with 25% nickel-plated 36AWG copper wire for additional strength

SERIES 75 METAL-CORE HELICALLY-WOUND CONDUIT PRODUCT SELECTION GUIDE

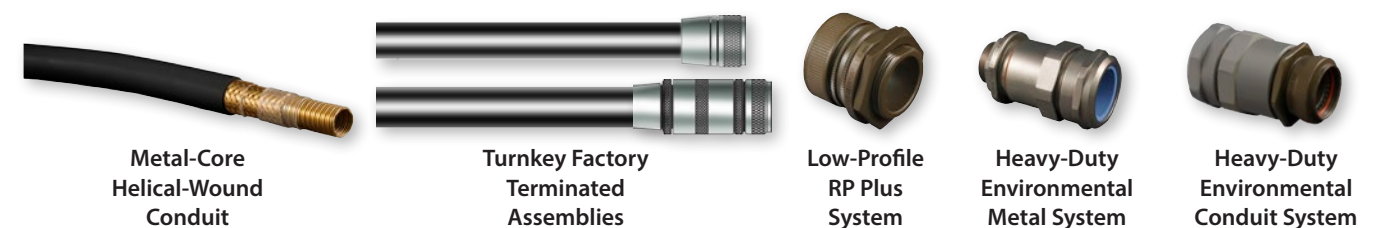





- Qualified to MIL-PRF-24758A(SH)
- User-installable and factory terminated configurations
- Innovative stainless steel fittings with advanced environmental sealing, EMI shield termination and rotatable coupling nut
- Adapters for all shipboard interfaces—fully compatible with legacy MIL-C-24758 conduit system components

Do it once, do it right with Glenair MIL-PRF-24758 and other special purpose wire protection conduit systems

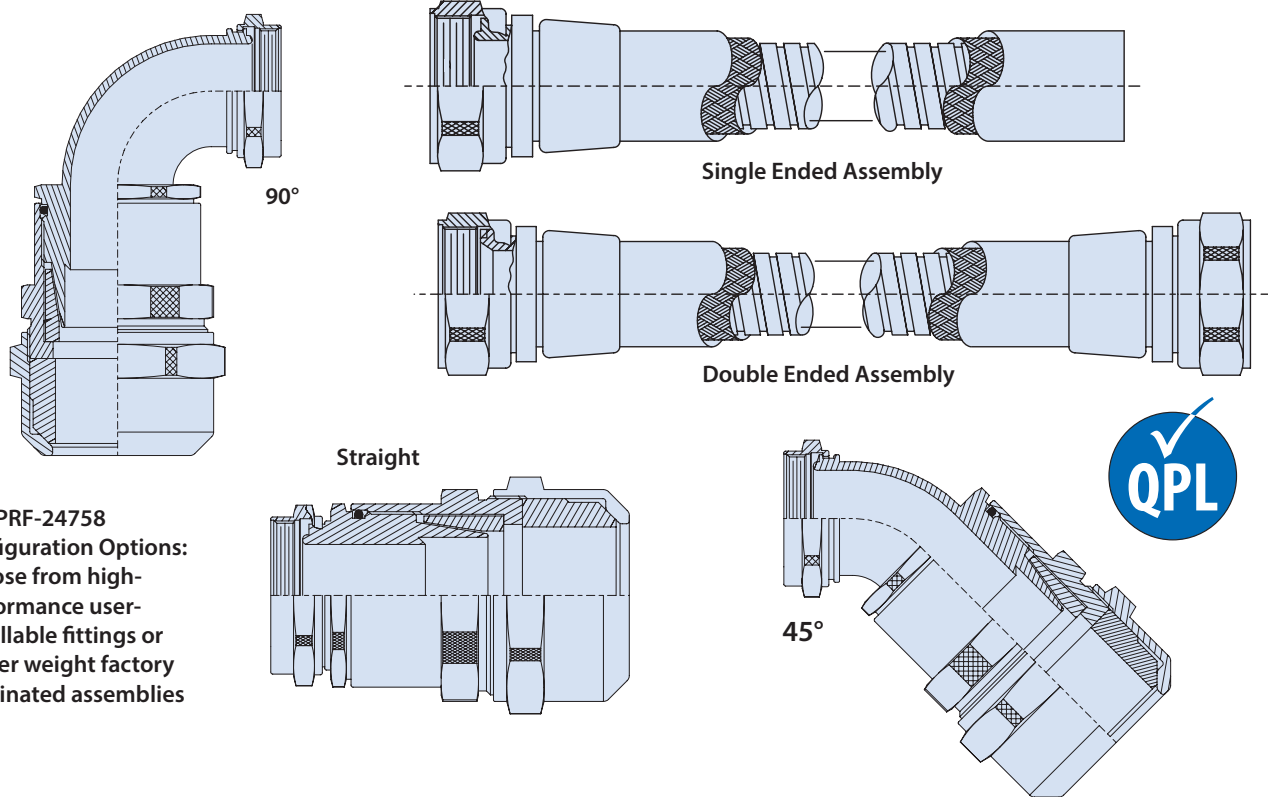

MIL-PRF-24758 Configuration Options: Choose from high-performance user-installable fittings or lighter weight factory terminated assemblies

WIRE-REINFORCED CONVOLUTED POLYMER-CORE TUBING



Reference Part No.  
(Consult factory for additional materials and configurations)

127 - 009

Glenair has developed a unique configuration where helical polymer-core tubing is reinforced with a stainless steel wire, adding at least 200 lbs. crush strength while maintaining the lightweight, chemical-resistant and environmental protection properties of Polymer-Core tubing.

SLIT POLYMER-CORE TUBING



Reference Part No.  
(Consult factory for additional materials and configurations)

120 - 144

Any of Glenair's regular bulk helical or annular polymer-core tubings can be provided slit, for on-site installation or addition of wires in open wire loom applications. Use the Wire Loom Tool for easy wire insertion: simply gather the wires into the tool, insert into the slit conduit, and run the tool through the tubing.



OVAL POLYMER-CORE ANNULAR TUBING

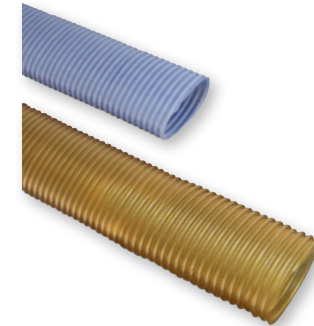

Reference Part No.  
(Consult factory for additional materials and configurations)

120 - 140 - 40

For specialized wire routing applications, Glenair can fabricate annular tubing with an oval shaped profile. In-house manufacturing allows us to design and fabricate non-standard shapes.

"NO-HAL" HALOGEN FREE FLEXIBLE HELICAL PEEK TUBING ASSEMBLY



Reference Part No.  
(Consult factory for additional materials and configurations)

127 - 130

The Glenair "No Hal" tubing assembly is designed for applications where RoHS compliance or other environmental standards mandate a halogen-free configuration. Halogen-free PEEK tubing (with optional stainless steel wire reinforcement for crush strength) is combined with Glenair halogen-free Duraelectric™ jacketing material. Add an optional braided shield for EMI/RFI protection.

CONVOLUTED POLYMER-CORE TUBING WITH DRAIN HOLES



Reference Part No.  
(Consult factory for additional materials and configurations)

120 - 143

For aerospace applications where altitude changes can cause moisture condensation within conduit, Glenair produces convoluted polymer-core tubing with drain holes. All major aircraft OEM hole patterns are on file, contact the factory for details on specific configurations.

DUAL-CORE TUBING



In applications where helical convoluted tubing needs to perform in harsh chemical environments, and weight savings is a concern, dual-core conduit is the answer. Glenair Series 74 Polymer-Core tubing materials are chemical- and UV resistant, and protecting the outside of tubing with a second layer of polymer tubing can save weight over standard jacketing. Consult the factory for Polymer-Core and braided shield material options.



# Backshells and Connector Accessories

For every environmental, mechanical, and EMI requirement

Backshells and Connector Accessories Product Selection Guide

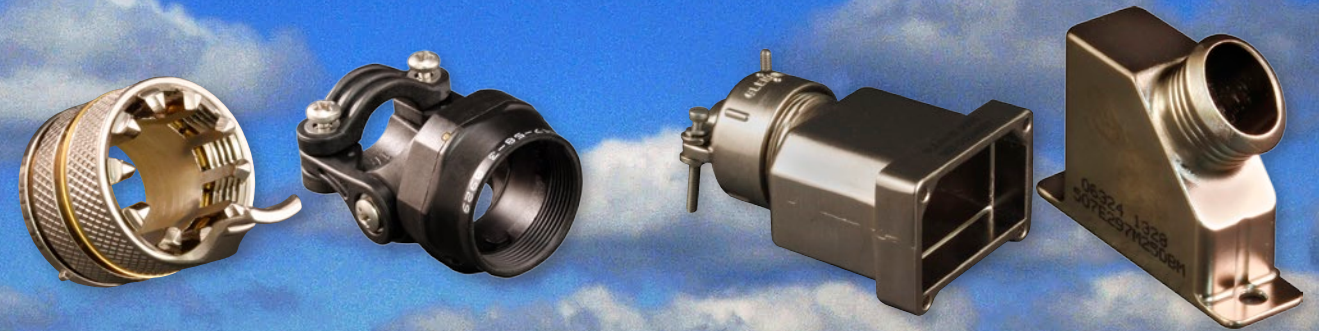

Circular Connector Backshells and Accessories

Rectangular Connector Backshells and Accessories



Composite Backshells and Accessories



EMI/RFI CostSaver Composite Junction Boxes



Glenair is one of the original military/aerospace manufacturers engaged in the design and production of high-performance backshells, dustcaps, shield termination devices and other connector accessories. In operation since 1956, Glenair has designed and produced more innovative connector accessory products than the rest of our industry combined. Glenair interconnect engineers are responsible for developing literally thousands of innovative connector accessories—from lightweight and corrosion-free composite thermoplastic strain reliefs to innovative fiber optic backshells. Today, the company is able to supply accessory solutions for every requirement, no matter how unique or challenging.



For more information contact Glenair at 818-247-6000 or visit our website at [www.glenair.com](http://www.glenair.com) U.S. CAGE code 06324





# QPL AND COMMERCIAL Circular Connector Backshells and Accessories



Innovation and availability: the Glenair connector accessory product line

- High-performance circular connector accessories for every environmental, mechanical and electromagnetic shielding requirements
- QPL'd AS85049 backshells
- Tens of thousands of popular part numbers in inventory ready for same-day shipment
- Fast turnaround on non-standard and made-to-order accessories, typically only two to three weeks
- RoHS compliant plating options

## PROTECTIVE COVERS AND STOWAGE RECEPTACLES

Proper environmental and mechanical protection of mission-critical connectors relies on protective covers and stowage receptacles. Only Glenair offers the complete range of these accessories for every connector series in active use, including the hard-to-find protective covers for MIL-PRF-39012 RF connectors shown here. All Glenair protective covers and dummy stowage receptacles are in-stock and available for immediate, same-day shipment.



## BACKSHELL INNOVATION SHOWCASE



TAG-Ring/Qwik-Ty® Feed-Through Fitting



Spring-Loaded "Flop-Lid" Protective Cover



Space Grade Quick Clamp Backshell



Ultra Low-Profile Backshell



Series 437-001 Backshell "Connector Saver"



Self-Locking, Anti-Decoupling Protective Covers



Ultra small-form-factor Mighty Mouse environmental backshell



High-Performance Banding Backshell

## STARSHIELD "ZERO LENGTH" INDIVIDUAL SHIELD TERMINATION BACKSHELL



- Eliminates "standing antenna" problems common with pigtail shield termination systems
- Utilizes heat shrink termination (HST) sleeve technology for fast and reliable shield termination—even with dissimilar wire types/gauges
- Available in a standard configuration featuring a threaded compression nut and a tapered split-ring that fits snugly into a conical backshell or a lightweight split banding version.

## STANDARD AND PRESSURE BOUNDARY FEED-THRU



High-performance, weight saving composite feed-thrus



EMI/RFI split-shell metal feed-thru

- High-grade engineering thermoplastic or machined metal
- Six pressure-boundary feed-thru layouts with accommodation for 1 – 6 cables
- Split-shell jam nut versions with EMI/RFI shield termination porch
- O-ring sealed panel and box mounting interface
- Conductive and non-conductive finish options





METAL AND COMPOSITE  
 Rectangular backshells and accessories  
 The world's largest *tooled* selection



METAL AND COMPOSITE  
**Rectangular backshells  
 and accessories**



Proven performance backshells and accessories for rectangular connectors

Glenair offers more tested and tooled rectangular interconnect products—including the world's broadest range of rectangular backshells—than any other supplier in the industry. Simply put, from the smallest Micro-D subminiature to the largest ARINC 600, Glenair has an unparalleled range of solutions. Need something light and corrosion free? Glenair is the industry leader in tooled composite thermoplastic connector accessories.

**QWIKSNAP™**



Glenair has developed an extensive range of lightweight QwikSnap™ backshells that completely eliminate assembly hardware in split-shell backshells. QwikSnap™ utilizes innovative composite spring latch technology to reduce weight, FOD, and accelerate assembly.



- All forms of environmental, mechanical and EMC backshells
- Straight, 45° and 90° cable routing
- High-temp composite thermoplastic and metal shell versions
- To fit all current and legacy rectangular connectors
- Innovative split-shell versions for easy access to wire terminations
- Equally large range of protective covers and caps
- Thousands of part numbers in stock and ready for immediate shipment

**MICRO-D AND NANOMINIATURE BACKSHELLS AND CONNECTOR ACCESSORIES**



**M24308 D-SUB SOLUTIONS: HIGH PERFORMANCE, RUGGEDIZED D-SUBMINIATURE PRODUCTS**



**LARGER FORM FACTOR RECTANGULAR BACKSHELLS**

EPX® and EPXB® are registered trademarks of Radiall







# COMPOSITE Circular and Rectangular Backshells and Accessories



## LIGHTWEIGHT Composite Backshells and Accessories

Corrosion resistance, weight reduction,  
durability and design innovation



- High temperature engineered thermoplastics for maximum strength and durability
- Total immunity to galvanic corrosion
- Up to 70% weight reduction compared to standard metal connectors and accessories
- Hundreds of innovative, tooled designs in stock



Composite Swing-Arm™ shield termination strain-relief clamp

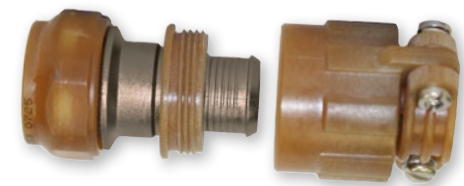

Composite Band-in-a-Can shield termination backshell and strain-relief clamp

### 1000 HOUR GREY™ Ni-PTFE NICKEL FLUOROCARBON POLYMER PLATING



The MIL-DTL-38999 Rev L detail specification lists Nickel Fluorocarbon Polymer as a qualified Cadmium free plating alternative. This highly conductive, RoHS compliant plating formula is now available on composite interconnect products from Glenair and offers the following benefits in harsh-environment applications:

- 2000+ hour salt spray
- Cadmium free
- Outstanding mating lubricity
- Hexavalent Chromium free
- 500+ mating cycles
- Non-Magnetic

### COMPOSITE DESIGN INNOVATION REDUCES CABLE HARNESS ASSEMBLY TIME



Composite QwikSnap™ M24308 Backshell



Composite Swing-Arm with Keyed Drop-In Banding Insert



All-In-One Booted "Piggyback" Backshell



Isolated Conductive Ground Path



Conductive composite protective covers



Non-conductive unplated protective covers



Composite Thermoplastic Vs. Common Metal Materials			
Material	Specific Gravity	Density (lbs. Inch <sup>3</sup> )	Salt Spray
Composite	1.27 - 1.51	.055	2000+ Hrs
Aluminum	2.55 - 2.80	.098	48-1000 Hrs
Titanium	4.51 - 4.62	.162	500-1000 Hrs
Stainless Steel	7.70 - 7.73	.284	500-1000 Hrs
Brass	8.40 - 8.70	.305	500-1000 Hrs

Glenair composite interconnect components are principally manufactured from 30% glass fiber polyetherimide (PEI). At room temperature PEI exhibits tensile strength yield of over 15,000 psi. The PEI material meets the most stringent outgassing and flammability requirements.

### ULTRA-LIGHTWEIGHT COMPOSITE THERMOPLASTIC SHIELD TERMINATION

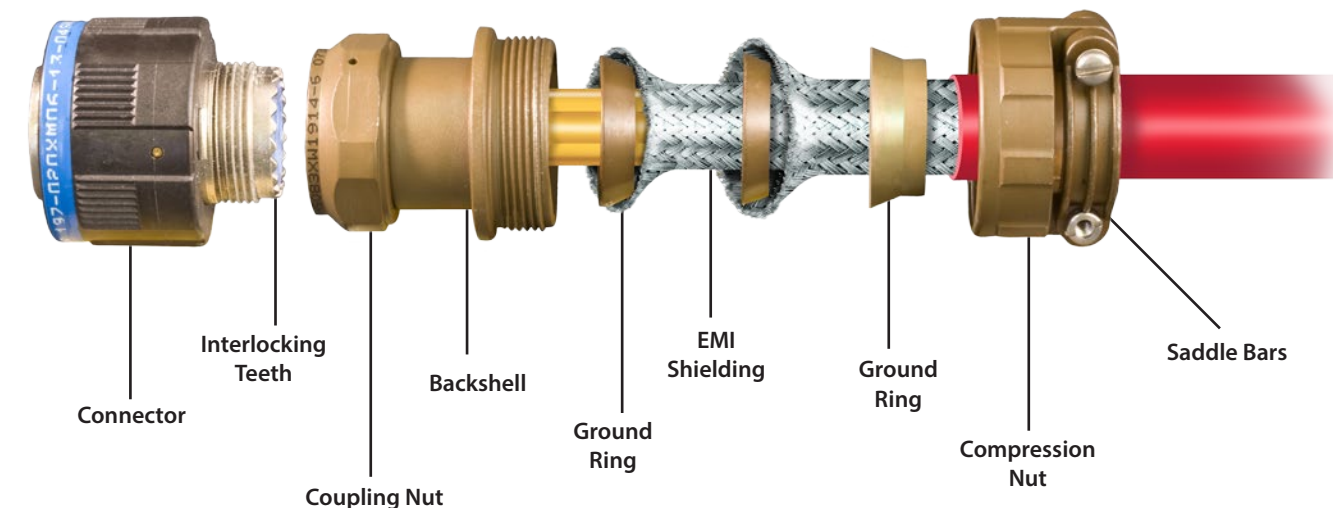





COST SAVER

# Shielded Composite Junction Boxes

Install it and forget it: Glenair corrosion-free EMI/RFI shielded composite junction boxes

- Over a dozen different tooled sizes and shapes.
- Extremely durable, corrosion-free, high temperature engineering composite thermoplastic
- Tested and qualified to U.S. Navy, UK MOD and hundreds of commercial aircraft and marine applications

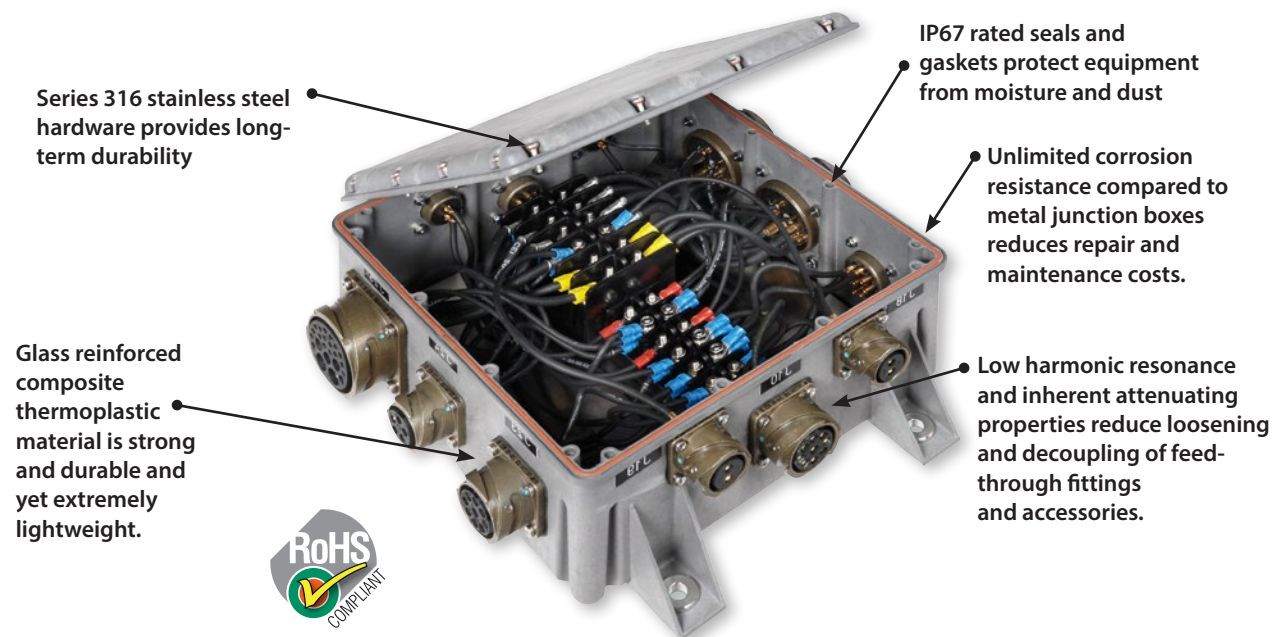

Series 316 stainless steel hardware provides long-term durability

IP67 rated seals and gaskets protect equipment from moisture and dust

Unlimited corrosion resistance compared to metal junction boxes reduces repair and maintenance costs.

Glass reinforced composite thermoplastic material is strong and durable and yet extremely lightweight.

Low harmonic resonance and inherent attenuating properties reduce loosening and decoupling of feed-through fittings and accessories.



EMI/RFI  
CostSaver

Composite junction boxes



## COMMERCIAL OFF-THE-SHELF AND CUSTOM COMPOSITE THERMOPLASTIC JUNCTION BOXES



Glenair Composite Box Product Specifications		
Description/Test Report	Requirement	Procedure
<b>Plating Adhesion</b> <i>Glenair #9-44-18/TN94-159</i>	Should not exhibit any blistering, peeling or other separation of the units plating.	Tested IAW MIL-DTL-38999.
<b>Vibration</b> <i>NTS #973-7369-2</i>	Should not exhibit loosening of component parts or evidence of damage.	Tested IAW MIL-STD-167 Type 1 for box units and MIL-STD-1344, Method 2004 Condition II for fittings and accessories.
<b>Shock</b> <i>MOD #BR8470 Grade C and F</i>	There shall be no loosening of parts or evidence of damage.	Tested IAW MOD BR 8470 Grade C and F.
<b>Salt Spray</b> <i>Glenair #9-44-18/TN94-159</i>	Should exhibit no exposure of underplate or base material.	Tested IAW MIL-STD-1344, Method 1001.
<b>Dust</b> <i>NTS #973-7369-1</i>	Should conform to required torque limits and functional requirement within 25%.	Tested IAW MIL-STD-202.
<b>UV Light Resistance</b> <i>GE RDM88050255-6042</i>	No degradation of the mechanical properties defined in the specification after testing.	Tested IAW ASTM D2565.
<b>Impact</b> <i>MIL-STD-1344, Method 2015</i>	No evidence of breaking or cracking of components or other damage that could affect the product performance.	Tested IAW MIL-STD-1344, Method 2015.
<b>Temperature Cycling</b> <i>NTS #575-9249</i>	No cracking, peeling or separation of plating or other functional damage.	Tested IAW MIL-STD-1344, Method 1003 at -65°C to 200°C.
<b>Hydrolytic Stability</b> <i>NTS #878-536</i>	No evidence of increased weight greater than 1% and no evidence of cracking, breaking or loosening of component parts.	Tested IAW ASTM D570-81.
<b>Flammability</b> <i>MIL-STD-1344, Method 1012, Smoke Index, NES 711 Issue 2, NES 713 Issue 3 and ISO 4589</i>	The item flame and after flow extinguishing time shall not exceed the defined limits.	Tested IAW Table II of of MIL-STD-1344, Method 1012, Smoke Index, NES 711 Issue 2, NES 713 Issue 3. Burning behavior by Oxygen Index, ISO 4589.
<b>Water Tightness</b> <i>EA #0C13513-039514</i>	Water tightness and internal pressurization is maintained.	Tested IAW EA #0C13513-039514.
<b>Outgassing</b> <i>JPL #081892</i>	Maximum allowable weight loss is 10%.	Tested IAW ASTM E 595.
<b>Electromagnetic Shielding</b> <i>TRW/ABQ-55C-1186-0</i>	Should demonstrate shielding effectiveness and transfer impedance conforming to military industry standards and specific customer requirements.	Tested IAW TRW/ABQ-55C-1186-0.



INDUSTRY STANDARD

# Interconnect Assembly Tools

The right tool for every interconnect assembly requirement

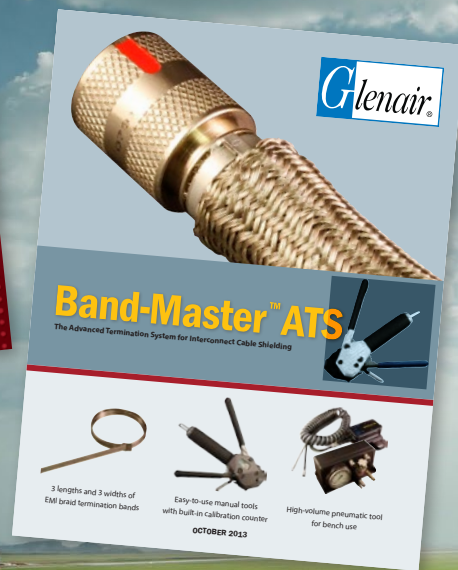
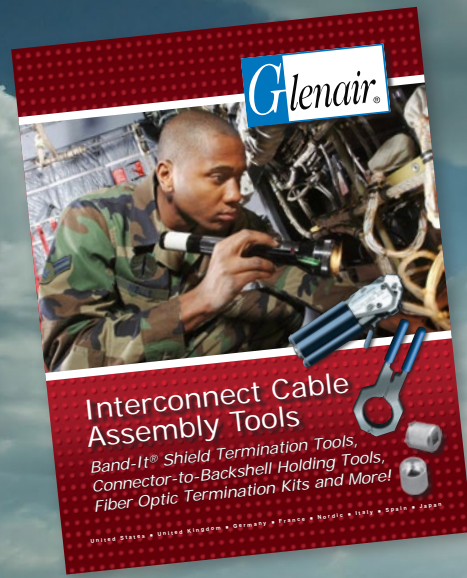

## Interconnect Assembly Tools Selection Guide



Backshell-to-Connector Assembly Tools



BandMaster™ ATS EMI/RFI Shield Termination System



Glenair offers its connector and connector accessory customers every convenience in the provision of contact termination, shield termination, and backshell-to-connector assembly tooling. We are also proud to offer branded solutions from other well-known tool manufacturers such as Daniels (DMC) crimp tools. From pneumatic Earth-Bond tooling for the rail industry, to fiber optic termination and test equipment, Glenair is your most knowledgeable and reliable source for special-purpose interconnect assembly tooling.



For more information contact Glenair at 818-247-6000 or visit our website at [www.glenair.com](http://www.glenair.com) U.S. CAGE code 06324



The advanced termination system for interconnect cable shielding

The advanced termination system for interconnect cable shielding



- Fast, cost-effective cable shielding termination
- Precision hand-held tool and bands deliver reliable, repeatable performance
- Single piece stainless steel bands in various sizes and lengths
- Clamp both small and large diameters easily and reliably
- Pneumatic banding tool for high-speed mass production
- Qualified for both military and commercial aviation

The Band-Master™ ATS provides quick, easy, cost-effective and highly reliable termination of braided metallic shielding or fabric braid to connectors and backshells.

Band-Master™ ATS is the advanced termination system for interconnect cable shielding. The unique low profile and smooth inside diameter of the one-piece type 304 austenitic stainless steel clamping band virtually eliminates RFI/EMI/EMP leakage paths. The lock maintains constant tension under extreme environmental conditions. Band-Master™ ATS bands have passed severe shock, vibration and thermal cycle testing with negligible deterioration of shell conductivity.



Glenair Band-Master™  
ATS Bands are also  
AS85049/128 qualified

Band-Master™ ATS Manual Tool Selection	
	<p><b>601-100 Hand Tool for Standard Bands</b></p> <p>The 601-100 Standard Band-Master™ ATS Tool weighs 1.18 lbs., and is designed for standard flat .24" width clamping bands (601-005, 601-040 and 601-049) in a tension range from 100 to 180 lbs. Calibrate at 150 lbs. ± 5 lbs. for most shield terminations. Tool and band should never be lubricated.</p>
	<p><b>601-101 Hand Tool for Micro Bands</b></p> <p>The 601-101 Micro Band-Master™ ATS Tool weighs 1.18 lbs., and is designed for micro .120" width clamping bands (601-024, 601-060 and 601-064) in a tension range from 50 to 85 lbs. Calibrate at 80 lbs ±5 lbs. for most shield terminations. Tool and band should never be lubricated.</p>
	<p><b>601-108 Hand Tool for Nano Bands</b></p> <p>The 601-108 Nano Band-Master™ ATS Tool weighs 1.18 lbs., and is designed for nano flat .075" width clamping bands (601-500, 601-504 and 601-508) in a tension range from 20 to 50 lbs. Calibrate at 50 lbs. ± 3 lbs. for most shield terminations. Tool and band should never be lubricated.</p>
	<p><b>601-109 Hand Tool for Slim Bands</b></p> <p>The 601-109 Slim Band-Master™ ATS Tool weighs 1.2 lbs., and is designed for slim standard flat .24" width clamping bands (601-570, 601-571, 601-572 and 601-573) in a tension range from 50 to 100 lbs. Calibrate at 100 lbs. ± 5 lbs. for most shield terminations. Tool and band should never be lubricated.</p>

**BAND-MASTER™ ATS ADVANCED TERMINATION SYSTEM**



Easy-to-use manual tools with built-in calibration counter



High-volume pneumatic tool for bench use



Save time and tool maintenance costs with the Glenair band tool calibration system



3 lengths and 3 widths of EMI braid termination bands plus new slim bands for size and weight savings—50% lighter and lower-profile than standard bands.

Bands	Length		Part Number		Fits Diameter	
	in.	mm.	Flat	Pre-Coiled	in.	mm.
Short Standard Band	9.0	228.6	601-005	601-006	1.0	25.4
Medium Standard Band	14.0	355.6	601-040	601-041	1.8	47.8
Long Standard Band	18.0	457.2	601-049	601-050	2.5	63.5
Short Micro Band	5.0	127.0	601-024	601-025	0.5	12.7
Medium Micro Band	8.0	203.2	601-060	601-061	.88	22.4
Long Micro Band	14.0	355.6	601-064	601-065	1.8	47.8
Short Nano Band	6.0	152.4	601-500	601-501	.60	15.2
Medium Nano Band	9.0	228.6	601-504	601-505	.94	23.9
Long Nano Band	14.0	355.6	601-508	601-509	1.8	47.8
Short Slim Standard Band	9.0	228.6	601-570	601-571	.94	25.4
Medium Slim Standard Band	14.25	362.0	601-572	601-573	1.8	47.8





BACKSHELL-TO-CONNECTOR  
Assembly Tools



INDUSTRY STANDARD  
**Assembly Tools**

Glenair offers a complete family of backshell assembly tools for most Mil-Standard circular connectors, as well as connector wrenches, strap wrenches, and universal connector holding tools



- Backshell-to-connector holding tools for all cylindrical connectors and accessories in current use
- Special composite thermoplastic coupling nut holding tools
- Discrete tools and complete sets available
- Popular Glenair strap wrenches
- Hand-held and bench-mountable digital torque wrenches
- Cutting shears and other special-purpose cable assembly tools
- Instructional videos, installation procedures and manuals available at [glenair.com](http://glenair.com)

**TORQUE WRENCHES AND BENCH STANDS**



Hand-Held Torque Wrench  
600-076 High Torque  
600-004 Standard Torque

Digital Torque Wrench  
600-161

600-162 Bench Stand for digital torque wrench with vertical and horizontal mounting options

**CONNECTOR HOLDING WRENCHES, PLUG AND RECEPTACLE HOLDING TOOLS AND KITS**



Connector holding wrenches, plug and receptacle holders for most military standard circular connectors

Plug Holder

Receptacle Holder

Universal Holding Tool Kit

- TG47 • MIL-DTL-22992
- TG48 • MIL-DTL-38999 Series II
- TG52 • MIL-DTL-81511 Series II and IV
- TG60 • MIL-DTL-27599 and MIL-DTL-38999 Series I
- TG61 • MIL-DTL-81511 Series I and II
- TG83 • (LN29729) for SJT Connectors
- TG90 • MIL-DTL-38999 Series III

**BACKSHELL ASSEMBLY AND REPAIR TOOLS AND KITS**



TG69 Soft Jaw Pliers

Glenair TG70 Strap Wrench with Square Drive for Torque Wrench

Coupling Nut Wrenches for Composite and Metal Backshells





HIGH-RELIABILITY

# Cable Assemblies and Integrated Systems

Customer bespoke cable harnesses and assemblies for mil/aero applications

Cable Assemblies and Intergrated Systems



Overmolded and ASAP Cable Assemblies

Wired Conduit Assemblies



Integrated Systems



Glenair has been the go-to cable house for high-performance interconnect cable assemblies for more than 50 years. We specialize in delivering terminated, tested cable harnesses and assemblies with 100% reliability and quality control. We offer complete, turnkey cable assembly services from design engineering to fabrication and test, and are qualified to all military and commercial aerospace standards.



For more information contact Glenair at 818-247-6000 or visit our website at [www.glenair.com](http://www.glenair.com) U.S. CAGE code 06324



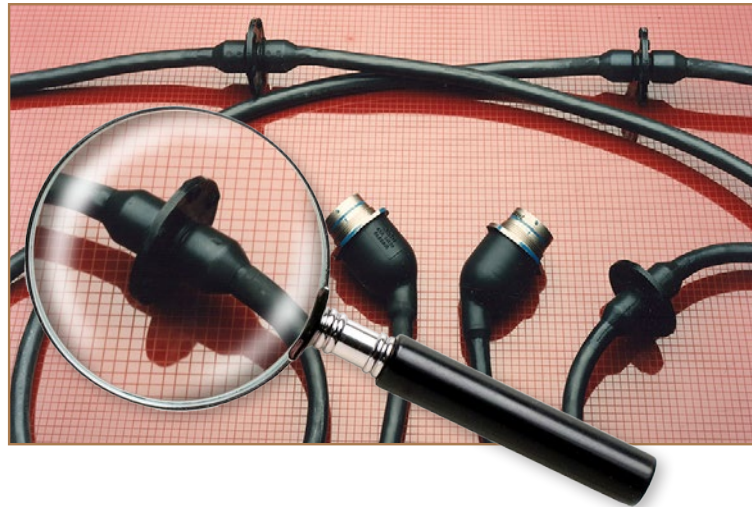

**Advantages of Overmolding**

- Waterproof sealing
- Robust mechanical protection
- Protection of terminations
- Ideally suited for chemical and fuel cell applications
- No induced cold flow stress
- Electrical isolation and insulation
- Reduced wear damage
- Flexible routing/cable entry

Terminated, overmolded, tested, and ready for use. Glenair cable harnesses and assemblies are recognized industry-wide for quality and reliability

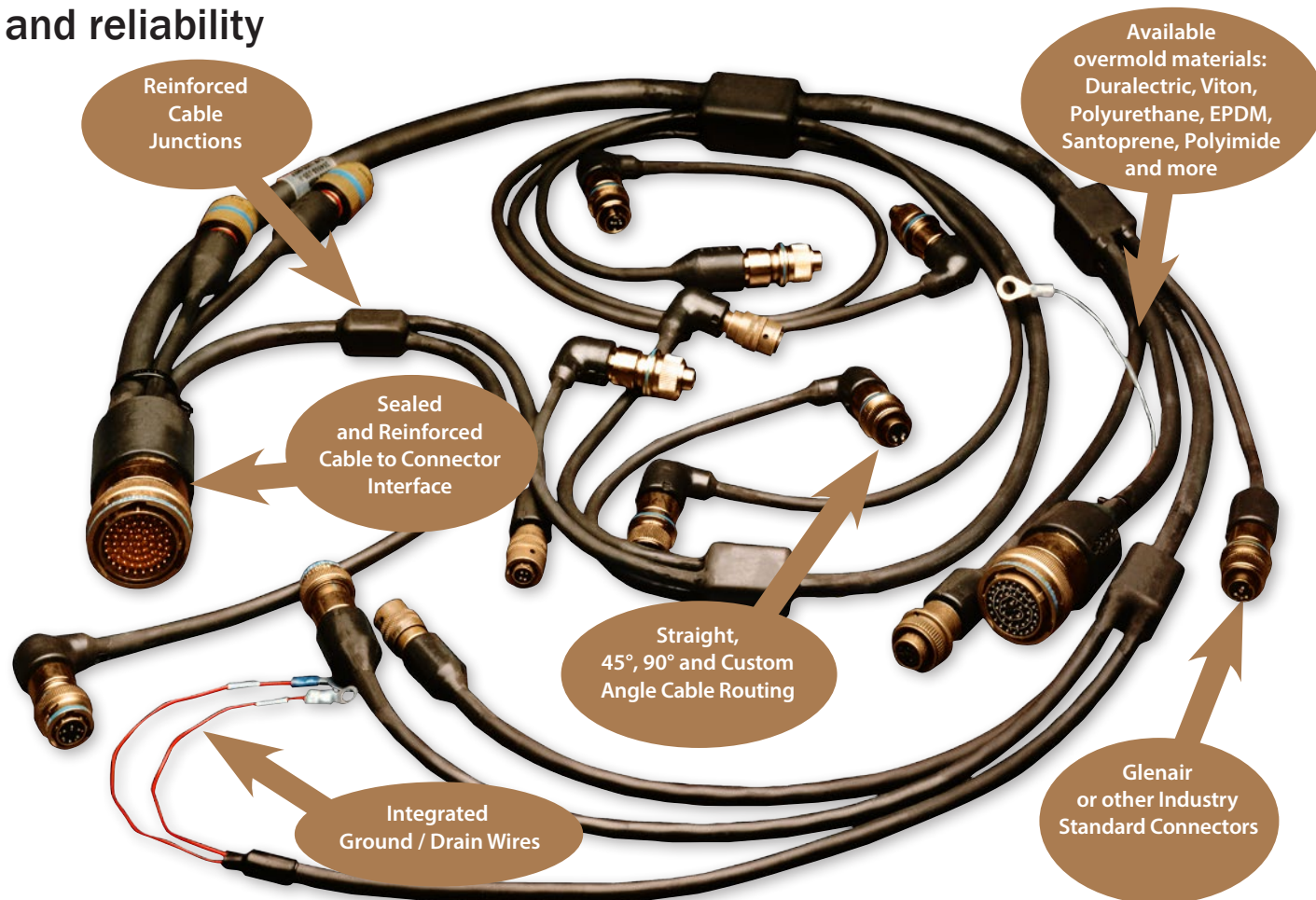

Point-to-point jumper cables and cordsets for high-speed and high-reliability applications—easy to order and shipped ready for immediate use

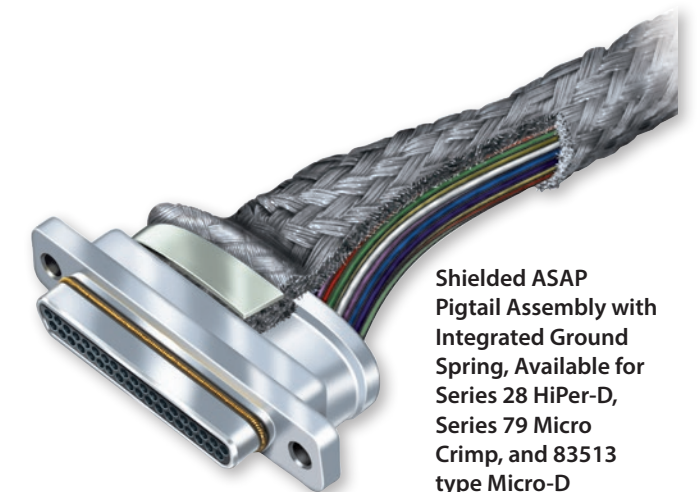
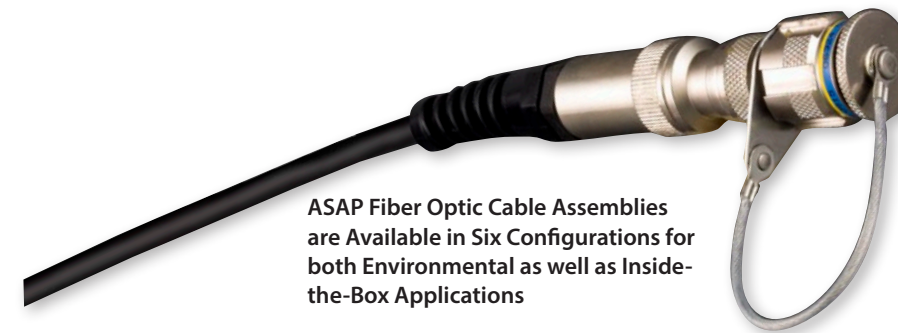





- Glenair can design, build, terminate—and even pre-wire—turnkey conduit wire routing solutions.
- Certified factory assemblers and calibrated tooling create better-performing systems.
- Simple point-to-point or complex multi-branch.

Reduce package size, weight, and labor with turnkey factory assemblies

Part Number  
744-204

**Series 74 Helical Polymer-Core Convuluted Tubing Assembly example:**  
Circular Connector Backshell to 45° Series 79 Micro-Crimp Connector Backshell

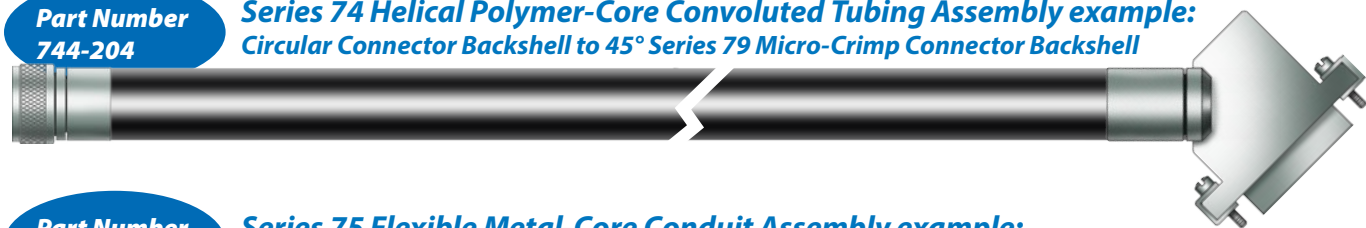

Part Number  
754-007

**Series 75 Flexible Metal-Core Conduit Assembly example:**  
Band-In-A-Can Connector Backshell to Band-In-A-Can Connector Backshell

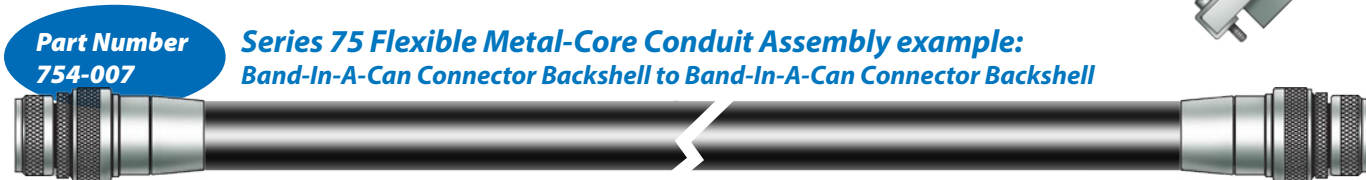

The Series 72 and 74 Polymer-Core Convuluted Tubing Systems offer the industry's broadest selection of high-performance materials—all designed to optimize flex cycles, temperature resistance, and weight reduction.

Internally-braided tubing systems provide a lightweight and chemically-resistant package without the use of conventional outer jacketing.

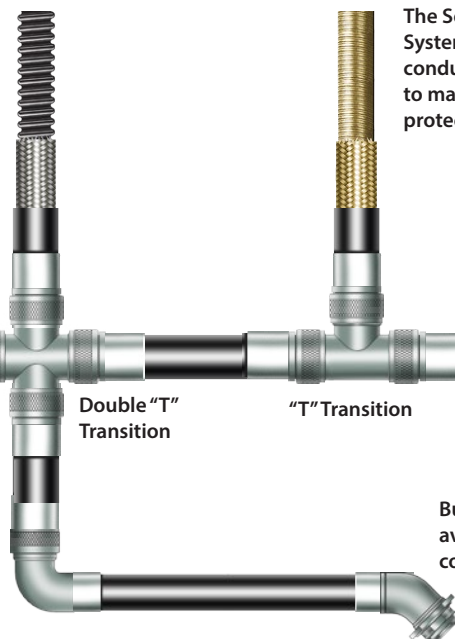

Detachable 90° Elbow Adapter for easy wire maintenance

Double "T" Transition

"T" Transition

Bulkhead Feed-Thru Fittings are available in Straight, 45°, and 90° configurations.

The Series 75 Metal-Core Conduit System offers a wide range of flexible conduit core materials, all designed to maximize crush resistance and EMI protection.

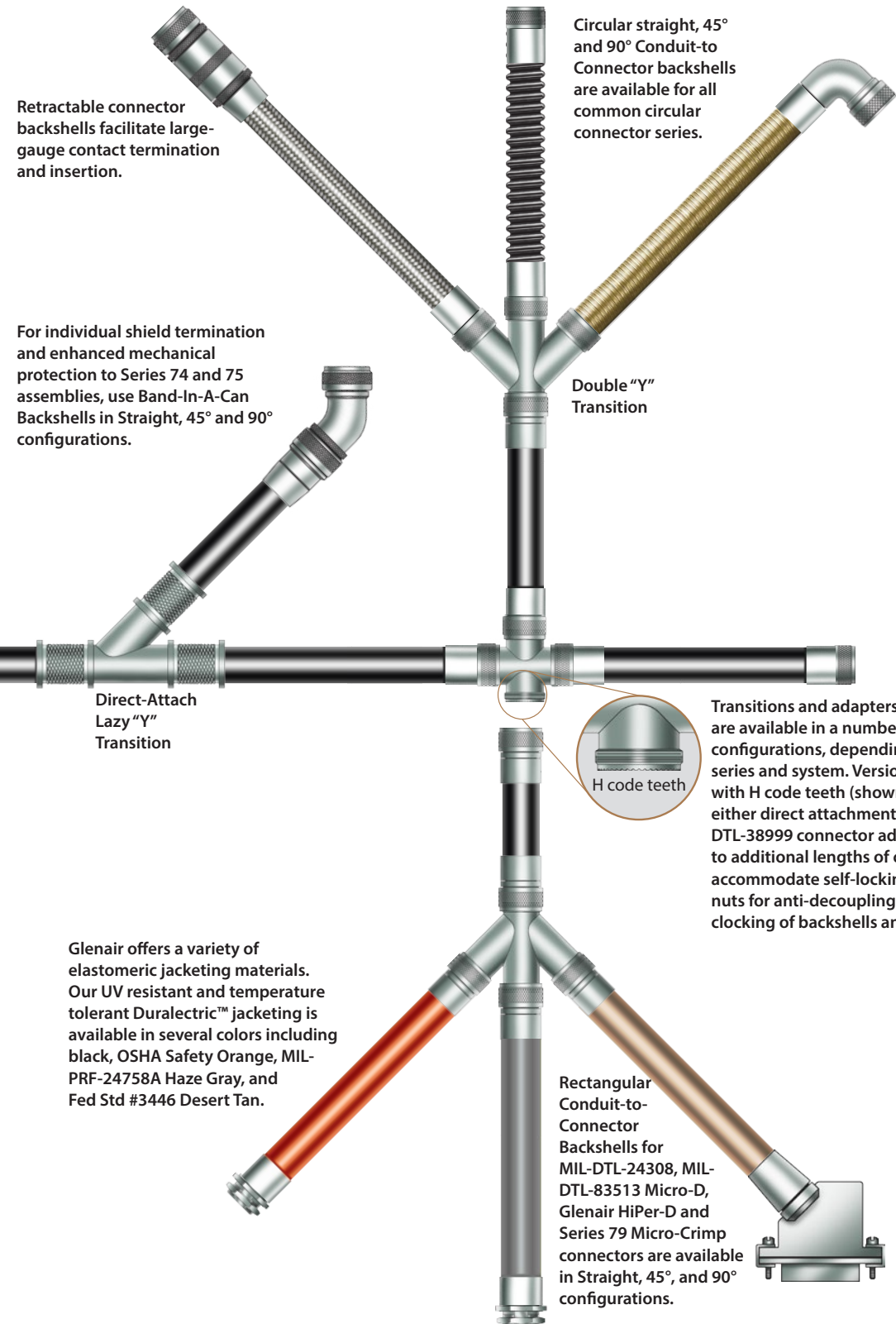

Retractable connector backshells facilitate large-gauge contact termination and insertion.

Circular straight, 45° and 90° Conduit-to-Connector backshells are available for all common circular connector series.

For individual shield termination and enhanced mechanical protection to Series 74 and 75 assemblies, use Band-In-A-Can Backshells in Straight, 45° and 90° configurations.

Double "Y" Transition

Direct-Attach Lazy "Y" Transition



Transitions and adapters are available in a number of configurations, depending on series and system. Versions with H code teeth (shown) for either direct attachment to MIL-DTL-38999 connector adapters, or to additional lengths of conduit, accommodate self-locking coupling nuts for anti-decoupling and easy locking of backshells and fittings.

Glenair offers a variety of elastomeric jacketing materials. Our UV resistant and temperature tolerant Duraelectric™ jacketing is available in several colors including black, OSHA Safety Orange, MIL-PRF-24758A Haze Gray, and Fed Std #3446 Desert Tan.

Rectangular Conduit-to-Connector Backshells for MIL-DTL-24308, MIL-DTL-83513 Micro-D, Glenair HiPer-D and Series 79 Micro-Crimp connectors are available in Straight, 45°, and 90° configurations.





MICRO/NANO

# Flex Circuit Assemblies



## ADVANTAGES OF FLEX CIRCUITRY

- Unsurpassed size and weight reduction
- Outstanding mechanical performance
- Convenient packaging and integration
- Reliable resistance to Harsh environments

Build-to-print interconnect assemblies that combine circuit board technology and cabling into a lightweight, integrated package.

Glenair turnkey design, termination and assembly services available worldwide.

### Turnkey AlphaLink™ Flex Jumpers

Circular Nano to AlphaLink® flex jumper	SuperFly to AlphaLink® flex jumper	Mighty Mouse to AlphaLink® flex jumper	Rectangular Nano to AlphaLink® flex jumper	Micro-D to AlphaLink® flex jumper	Micro-Crimp to AlphaLink® flex jumper

BUILD-TO-PRINT

## Flex circuit assemblies for mission-critical applications

Four reasons to specify flex in your next application



### 1. UNSURPASSED EXPERIENCE IN MICRO/NANO FLEX CIRCUIT ASSEMBLY

Glenair has been integrating Micro-D and Nanominiature connectors into flex circuitry for over 30 years. Our technical capabilities include design and layout of turnkey assemblies as well as the production of custom-configured micro and nano interconnects for maximum size and weight savings.

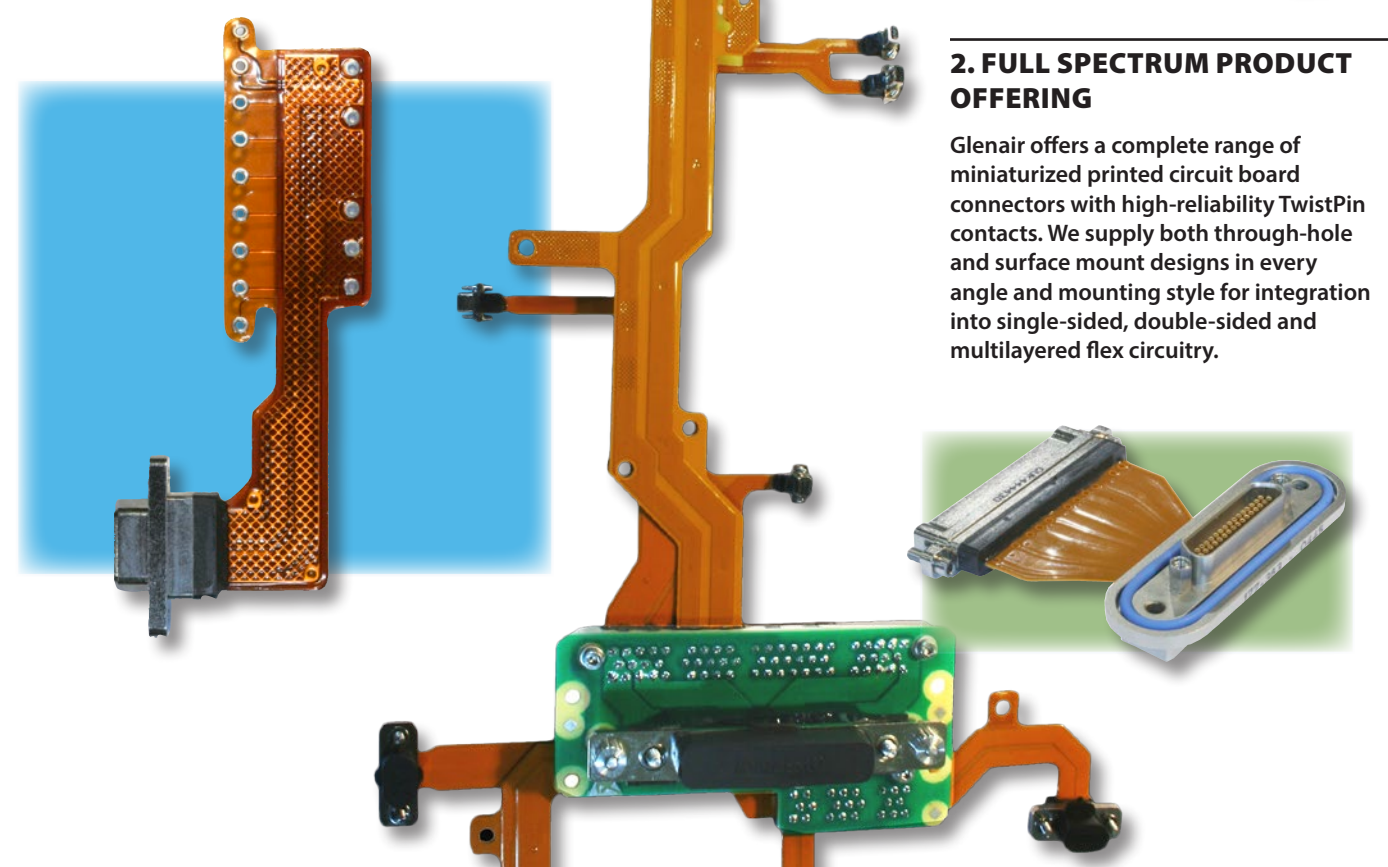
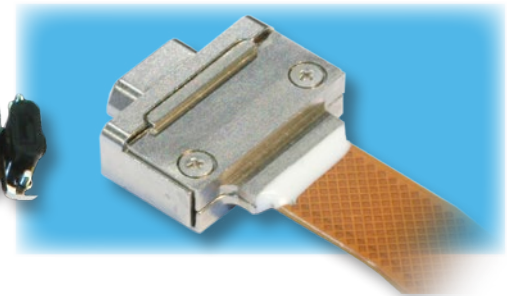

### 2. FULL SPECTRUM PRODUCT OFFERING

Glenair offers a complete range of miniaturized printed circuit board connectors with high-reliability TwistPin contacts. We supply both through-hole and surface mount designs in every angle and mounting style for integration into single-sided, double-sided and multilayered flex circuitry.



### 3. APPLICATION DESIGN

Our turnkey Micro-D and Nanominiature flex circuit assemblies are produced to exacting specifications. Customer-supplied concepts and designs are reviewed and revised to ensure the most advantageous utilization of EMI shielding, polarization, strain-relief and connector packaging technologies. At Glenair, the final design solution is optimized to meet the exact mechanical and electronic requirements of the target environment.

### 4. TERMINATION EXPERTISE

Glenair's experienced workforce is trained and qualified to produce consistently reliable circuit terminations using the most advanced techniques and technologies, including automated solder reflow systems.







# Pure Air/Nitrogen Cooling Systems

Complete systems and ancillaries for IR guided weapons and weapons ejection applications

Glenair high pressure Pure-Air/Nitrogen gas solutions are designed and performance tested for use in a wide variety of Defence, Aerospace and Other applications, including cooling of infrared detectors, missile seekers and all high pressure pneumatic actuation and deployment systems. Products include, Sealed for Life Gas Supply Systems, Re-chargeable Gas Supply Systems, High Pressure Solenoid Valves (miniature & low voltage), Small Bore pipe Assemblies, Relief Valves, Integrated Manifold Assemblies, Charge Valves and High Pressure Vessels. All Systems and Ancillaries are designed for direct incorporation into Joule Thompson (JT) cryogenic systems and all applications which require reliable pressurization, blow down, actuation, and IR Cooling. Glenair Pure-Air and High Pressure Systems and components are designed to exact customer requirements and specifications.

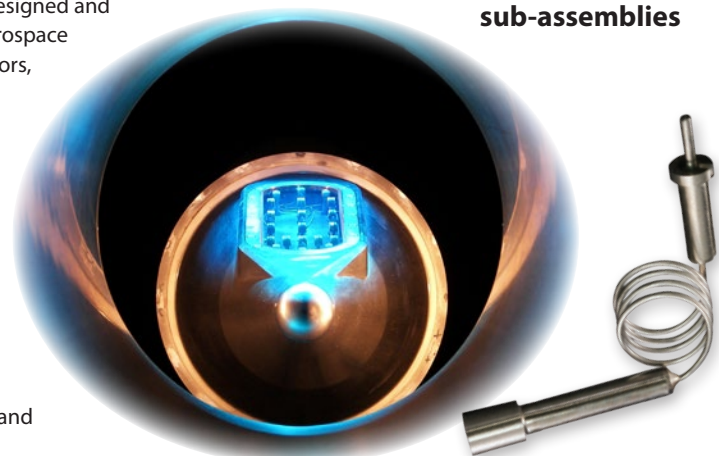

- Ultraminiature and lightweight pneumatic components and sub-assemblies
- Brazed stainless steel pipework
- Pure air and nitrogen (DEF STAN 58-96)
- High-pressure cylinders, solenoid valves, manifolds, and complete sub-assemblies

## PURE AIR/NITROGEN Lightweight Modular Cooling and Actuation Systems



Glenair pure gas/nitrogen systems and sub-assemblies provide passage of nitrogen and other pure, pressurized gases through precision-machined components such as pressure regulating valves, solenoids, and Joule-Thompson cryogenic cooling systems. Assemblies feature precision stainless steel pipeworks and tubing which are fabricated using a flux-free brazing process and are ultrasonically cleaned and packaged in a sealed, dust-free environment. Electromechanical components are also precision-machined with material properties and dimensional attributes per customer specifications.

- Manifold Assemblies – including Charging Valves, Relief Valves or Burst Discs, Pressure Gauges, Control Valves
- Pipework Sub-Assemblies connecting cylinders to manifolds or components
- Pressure Regulating Valves
- Solenoid Valves – manifold or in-line; single or two-stage
- Manifolds to other sub-assemblies

Typical Performance	
Flow Rate	Typical Flow Rate is 5 liters per minute (lpm) @ 150 PSI.
Operating Temperature	-65°C +175°C for all applicable mechanical requirements.
Physical Shock	No loosening of parts, cracking or other deleterious results hindering further part operation after 300 G's in each of 3 mutually perpendicular planes.
High Impact Shock	All components withstand high impact shock per MIL-S-901.
Vibration	All components withstand high-vibration with no evidence of cracking, breaking or loosening of parts.



Pressure test rig



Gas tube helium leak test equipment



Pure air compatibility test equipment



Brazing control panel

Solutions built to exact customer requirements and specifications

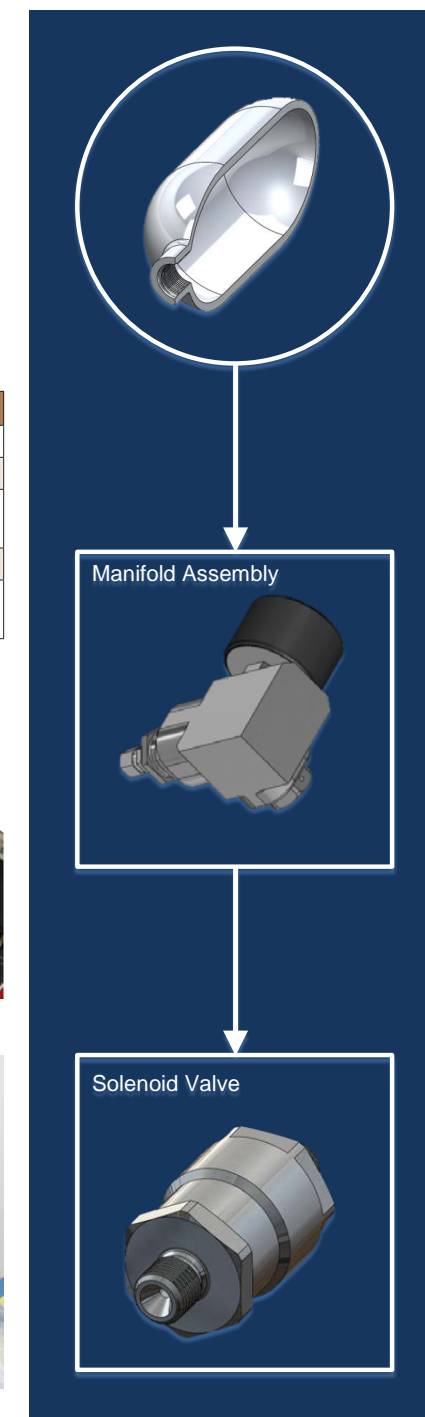





SERIES 06

# Hold-Down Release Mechanism Technology

High-reliability, non-explosive electromechanical release mechanism technology for dependable stowage and release of deployable space systems

Glenair HDRM device technology is optimized for reliability with built-in mechanical and electrical redundancy. The planned release of the deployable system is activated by a pre-determined value of electrical current to a fuse-wire system which causes the wire to break under tension and allow the pre-loaded mechanical bolt to actuate. Glenair is now positioned to incorporate HDRM technology into a broad range of customer-defined housing and mounting configurations.



- Electromechanical (non-explosive) technology
- Immune to electromagnetic interference
- User-serviceable and reusable
- Scalable design, up to 40,000 lbs. preload
- Ultra-low-shock release



For more information contact Glenair at **818-247-6000** or visit our website at **www.glenair.com**

SERIES 06

# Hold-Down Release Mechanism Technology



## Resets in Minutes

Glenair hold-down release mechanism (HDRM) technology is based on a fusible wire-actuated separation nut design. Increasingly popular for its reliability and non-pyrotechnic action, fusible wire-actuated nut technology has the added benefit of being partially reusable and refurbishable post-deployment. Glenair HDRM technology is immune to all forms of EMI or ESD, and is capable of easily sustaining launch loads as well as defined preloads—with release deployment times comparable to conventional explosive actuators, but with low-shock and low power input.

A broad range of hold down release mechanism technologies have been historically used to secure and subsequently deploy satellites and other appendages (solar arrays, antenna reflectors, radiators, instruments, doors, sensors, booms, and so on) in space. Most of these technologies relied on non-reusable (explosive/pyrotechnic) designs that suffered from a broad range of deficiencies, including susceptibility to electromagnetic interference, problematic synchronization of release with mission requirements, high-shock release action, and significantly, the inability to reuse or refurbish the device during test. Historically, actuators and release devices of this type have included:

- Explosive release nuts
- Bolt cutters
- Separation nuts
- Wire and pyro cable cutters

Glenair has taken a different path in the development of a non-explosive HDRM with a consumable initiator which, post-actuation, allows the device to be refurbished and reset on-site, or at the factory. Glenair fusible wire-actuated nut technology solves all of the problems associated with conventional explosive HDRM devices. In addition, the three key components of the Glenair HDRM (preloading assembly, release actuator, and load-carrying structure) may be packaged according to specific customer requirements including the addition of connectors to replace wire leads, cylindrical or rectangular housings, lightweight materials, package size and profile, mounting dimensions and so on. Consult the Glenair HDRM team at our Glendale factory for more information.



7/16 inch unit with 35,000 pound preload and connectorized interface



1/4 inch unit with 5,000 pound preload and conventional wire lead interface

Physical characteristics for 1/4 inch unit	
Mass	228 grams nominal weight with 18 inch lead wire included
Bolt	1/4-28 UNJF-3B*
Material list	IAW MSFC-STD-3029
Epoxy	Outgassing requirements per GSC19384

Device features for 1/4 inch unit	
Redundant initiation	2 initiation points
Field refurbishable	Initiator can be replaced in less than 15 minutes by trained personnel
Reliability prediction	0.9999995
Packaging	External housing typically supplied with two mounting points. Custom housings and mountings available
Connectorization	Standard design supplied with wire inputs. Connectorized versions available
Scalable bolt size	Bolt size determines preload and can be scaled to accommodate a wide range of requirements

\*The size callout is based off the bolt size that is to be used. Metric thread can also be called out. Complete test report available upon request







INTEGRATED SYSTEMS

Turnkey complex cable assemblies • junction box assemblies  
wired avionic control panels • connectorized backplanes

# Integrated Systems

Turnkey, precision-machined wired chassis, integrated electronic/photonic systems *plus* Glenair-built interconnect cabling

Glenair, together with our precision machining partner Dynamax, is able to offer our defense, aerospace and other customers fast, turnkey build-to-print integrated system solutions. From landing gear assemblies to in-flight entertainment platforms, Glenair is uniquely positioned to leverage our component manufacturing, interconnect cable assembly and structural member fabrication capabilities to meet the broadest range of integrated system requirements. Our US-based factories in Glendale, California and Chicago, Illinois are FAA, Mil and ISO 9001 certified, and ready to tackle any integrated system requirement for today's high-performance military and aerospace applications. Our Glenair UK facility is also Mil and ISO 9001 certified and in addition offers ESA and BS certified components and technologies. Glenair Italia is equally credentialed and adds IRIS (International Railway Industry Standard) certification and operates an IEC certified test lab. Our worldwide design and manufacturing teams are ready to provide start-to-finish engineering and assembly support on even the most complex integrated system projects.

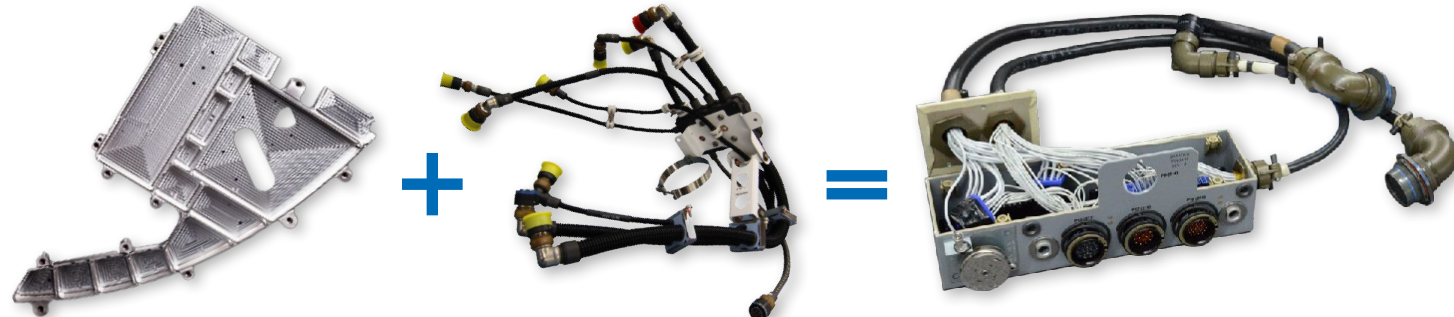

Precision-machined, injection molded or stamped-and-formed boxes and structural members

Multibranch interconnect cable harnesses and assemblies—terminated, tested, and ready for use

Turnkey integrated system components: Vertically integrated manufacturing, from backplanes to avionic control panels

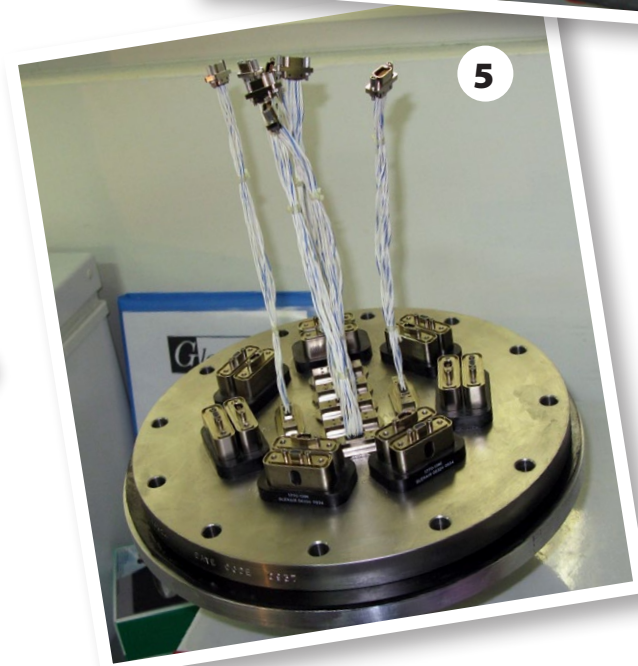
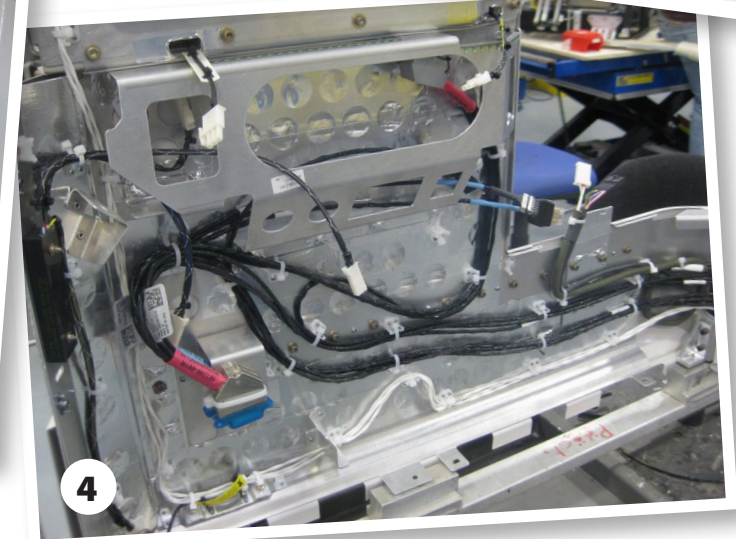
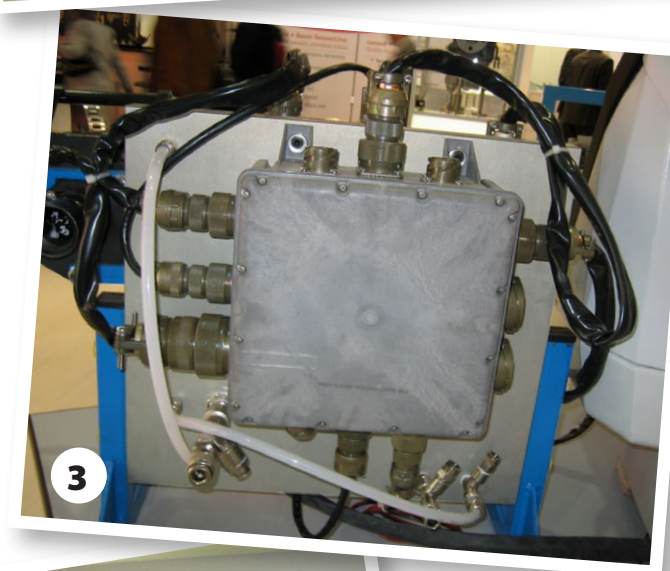
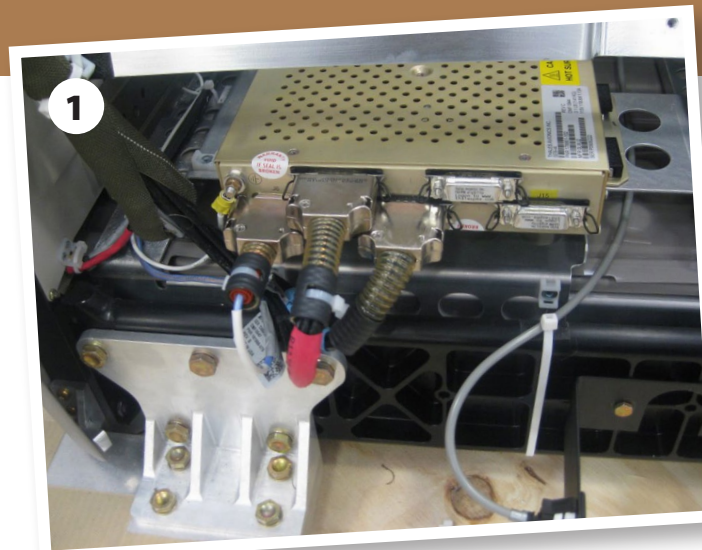

*Integrated systems: all interconnect components, boxes and machined chassis manufactured by Glenair. All cabling and final integration completed by Glenair. Glenair engineering provides extensive design support throughout.*

**Figure 1:** Integrated in-flight entertainment console and cabling

**Figure 2:** Wired unmanned vehicle control module

**Figure 3:** Rail industry corrosion-resistant junction box assembly

**Figure 4:** Business-class seat chassis with integrated cabling

**Figure 5:** Stainless steel vacuum plate with machine-integrated Micro-D connectors and jumpers



For more information contact Glenair at 818-247-6000 or visit our website at [www.glenair.com](http://www.glenair.com) U.S. CAGE code 06324





# Service and Support

*Our high-availability business model puts customer service, support, and convenience first*

*Every factory operation controlled by Glenair—from machining to molding, plating, testing and assembly*

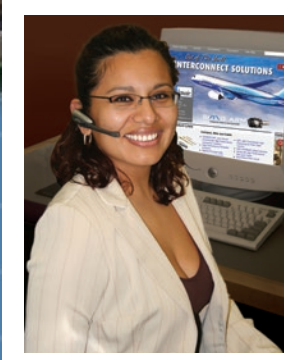

Fast Turnaround on Quotes and Orders



Huge "Same-Day" Inventory



Abundant Machining Capacity



Plenty of Raw Materials

No Dollar or Quantity Minimum Orders  
**NO MINS.**



Made in America since 1956

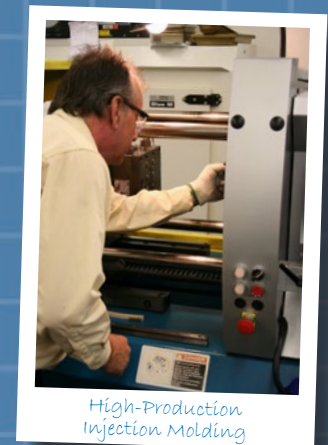
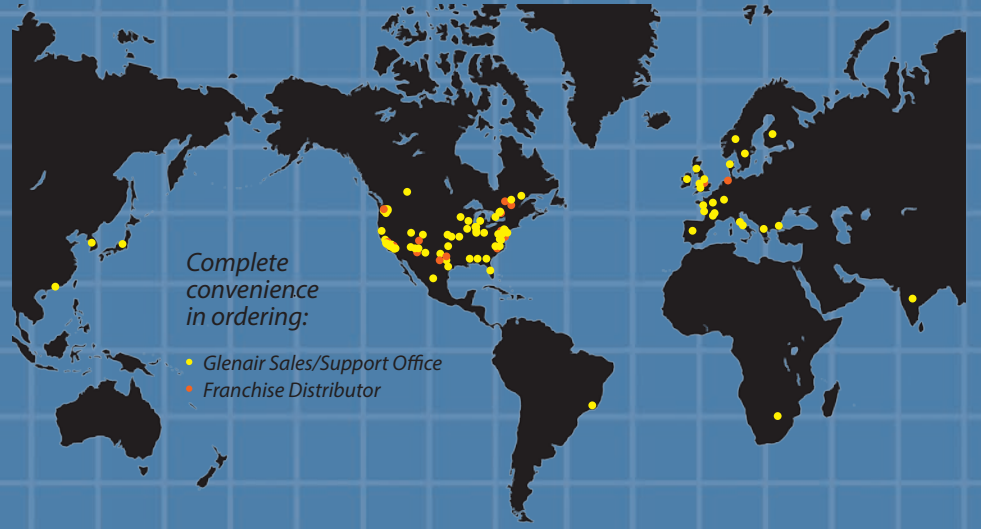

High-Production Injection Molding



Cable Assembly Overmolding

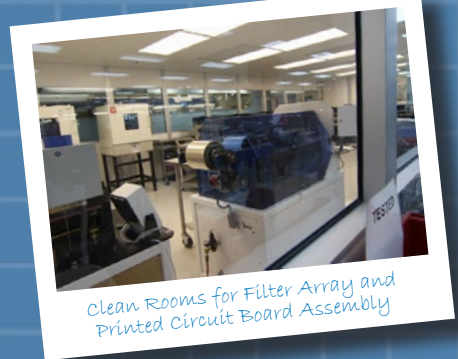

Clean Rooms for Filter Array and Printed Circuit Board Assembly



The Industry's Most Advanced EMI/RFI Braided Shielding Operation

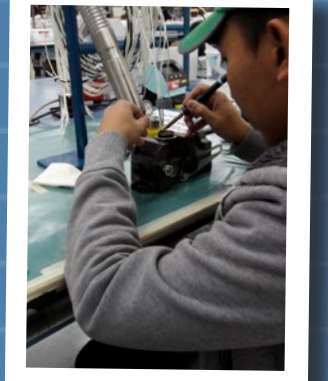

NASA-STD-8739.3/ENG-5213 Certified Soldering



State-of-the-Art Plating Capabilities



In-House Connector and Cable Harness Assembly



Test and Burn-In Labs for Both Electrical and Optical Systems





# Backshells and Beyond

Glenair is a full-spectrum interconnect supplier—manufacturing a complete range of solutions in Glendale since 1956

More Glenair milestones and innovations:

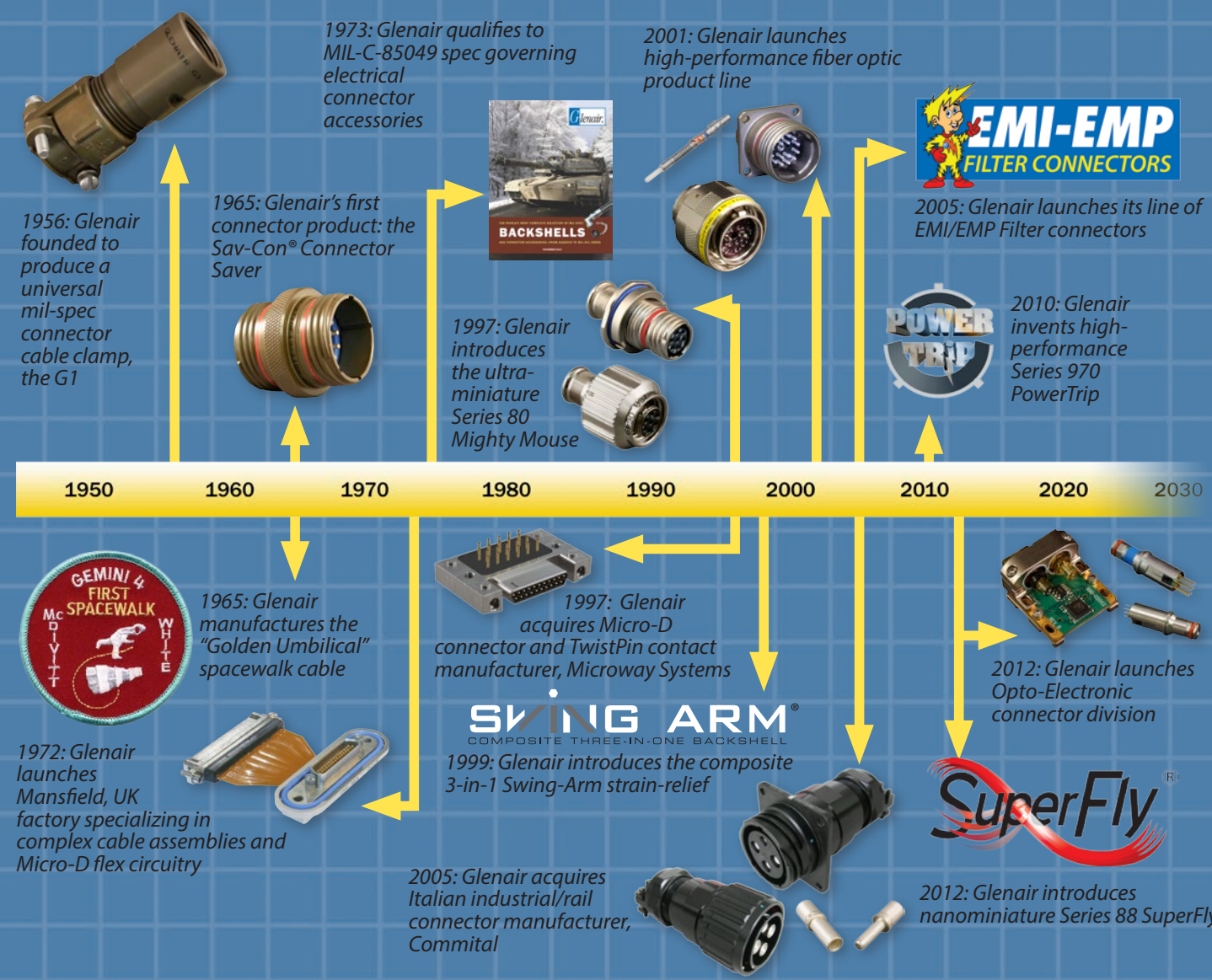

**HiPer**  
**MICROCRIMP**  
**SuperNine**  
**Stinger**  
**Geo-Marine**  
**STARSHIELD**  
**Hermetic**  
**Super Seal**  
**Band-Master ATS**  
**Amber Strand**  
**ELLI NELSON**  
**Octobyte**  
**SAV-CON**  
**MIGHTY MOUSE**  
**ARMORLITE**  
**Well-Master 260**





# Engineering Services

The industry's most experienced engineering and design team—in every discipline—from backshells to flex circuit boards

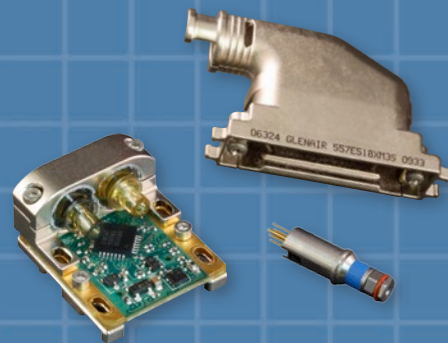

Glenair design expertise extends from innovative composite backshells to complex opto-electronic assemblies

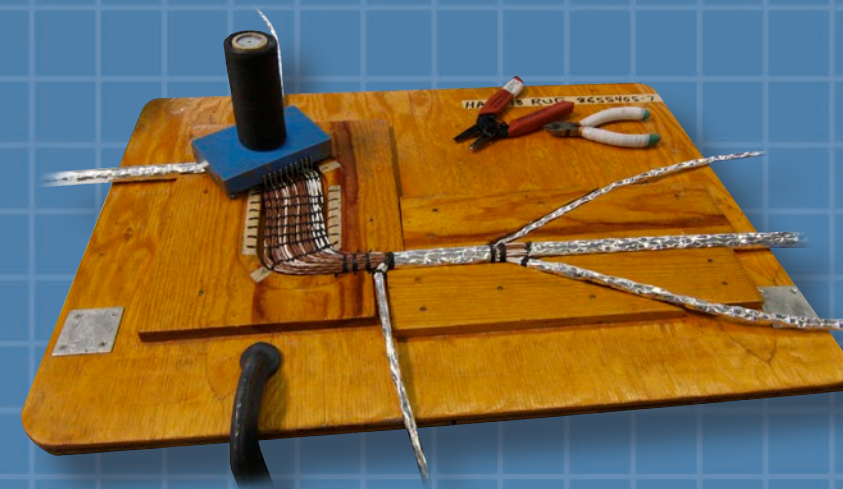
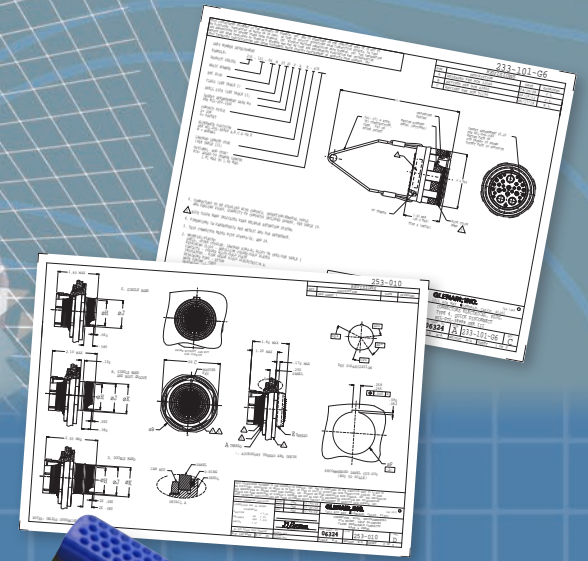

Manufacturing engineering is an art form at Glenair—particularly in our complex cable group



Our tooling design team has all the capacity required for even the most aggressive production schedules



Let us be your design partner: Glenair has the most liberal NRE policy in the industry



Glenair's engineering team in Glendale is augmented by regional teams worldwide, and we love to travel. Our place or yours? We work at our customers' convenience.

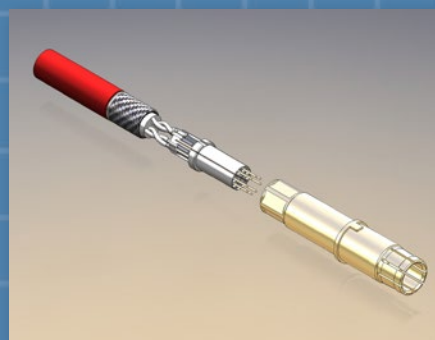

Glenair excels in the design of miniaturized components such as this full Gigabit Ethernet contact

No one in our industry has more engineering experience with composites, and other innovative materials, than Glenair



Four of the many reasons our engineering team takes their work so seriously:







# Committed to Quality

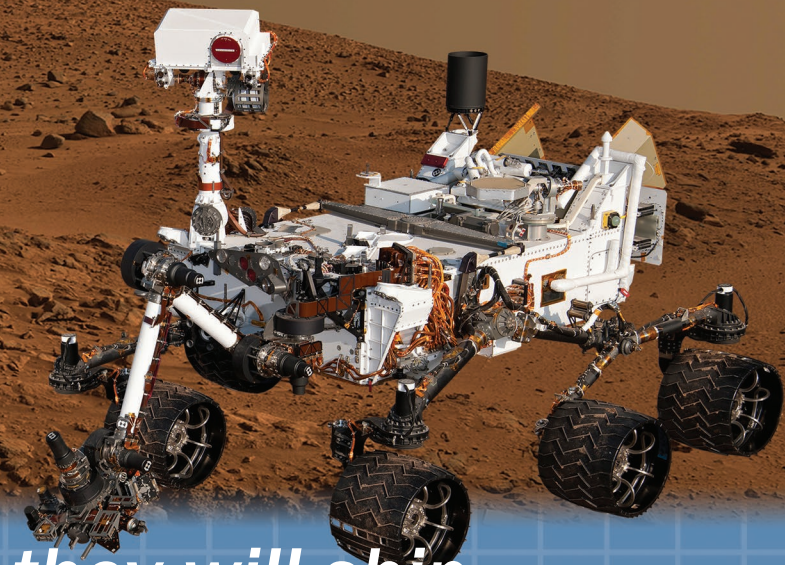

How can you be sure Glenair connectors are high-quality and will deliver long-term reliable performance?

How can you be sure they will ship on time and in the correct quantity ordered? Here are seven things to consider:

## 1 Mil-Spec Certifications:

Glenair is qualified to hundreds of rigorously controlled product and process certifications administered by the US government.



## 2 Certified Quality System:

Glenair is ISO 9001:2008 and AS9100:2009 Rev. C certified and registered in North America; IRIS (International Railway Industry Standard), AS9100 SAE Aerospace and ISO 9001 certified and registered in Italy, and AS9100 certified and registered in the U.K.



3 Satisfied Customers: Hundreds of world-class OEMs and system manufacturers have tested and qualified our products. Many conduct independent audits of Glenair quality on an annual basis.

4 Design Partner: Not just a supplier, Glenair has been a key design partner on thousands of successful electrical/optical interconnect applications



5 Go-To Supplier: In applications where a single fault can lead to mission failure, Glenair is selected time and time again—from high-pressure subsea applications to missions to Mars.

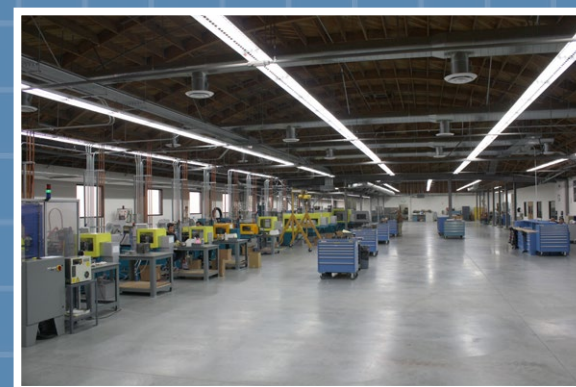

6 Factory Capacity: Our first-world factories, the largest in the mil-aero interconnect industry, are positioned for ongoing growth and materials/process compliance.



7 In-House IEC Qualified Assessment Laboratory: Our one-of-a-kind commitment to qualification testing and product quality includes comprehensive environmental, mechanical, and electrical test capabilities.





*Out of This World*  
**INTERCONNECT  
SOLUTIONS**

**Glenair, Inc.**

1211 Air Way • Glendale, California • 91201-2497  
Telephone: 818-247-6000 • Fax: 818-500-9912 • sales@glenair.com  
[www.glenair.com](http://www.glenair.com)

**Glenair Power  
Products Group**

860 N. Main Street Extension  
Wallingford, CT  
06492

Telephone:  
203-741-1115  
Facsimile:  
203-741-0053  
sales@glenair.com

**Glenair UK Ltd**

40 Lower Oakham Way  
Oakham Business Park  
P.O. Box 37, Mansfield  
Notts, NG18 5BY England

Telephone:  
+44-1623-638100  
Facsimile:  
+44-1623-638111  
sales@glenair.co.uk

**Glenair Microway Systems**

7000 North Lawndale Avenue  
Lincolnwood, IL  
60712

Telephone:  
847-679-8833  
Facsimile:  
847-679-8849

**Glenair Nordic AB**

Gustav III : S Boulevard 46  
S - 169 27 Solna  
Sweden

Telephone:  
+46-8-50550000  
Facsimile:  
+46-8-50550001  
sales@glenair.se

**Glenair Electric GmbH**

Schaberweg 28  
61348 Bad Homburg  
Germany

Telephone:  
06172 / 68 16 0  
Facsimile:  
06172 / 68 16 90  
germany@glenair.com

**Glenair Iberica**

C/ La Vega, 16  
45612 Velada  
Spain

Telephone:  
+34-925-89-29-88  
Facsimile:  
+34-925-89-29-87  
sales@glenair.es

**Glenair Italia S.p.A.**

Via Del Lavoro, 7  
40057 Quarto Inferiore –  
Granarolo dell'Emilia  
Bologna, Italy

Telephone:  
+39-051-782811  
Facsimile:  
+39-051-782259  
info@glenair.it

**Glenair France SARL**

7, Avenue Parmentier  
Immeuble Central Parc #2  
31200 Toulouse  
France

Telephone:  
+33-5-34-40-97-40  
Facsimile:  
+33-5-61-47-86-10  
sales@glenair.fr

