

# QwikConnect®

GLENAIR • JULY 2023 • VOLUME 27 • NUMBER 3



**GROUNDING AND  
BONDING IN AIRCRAFT**



# GROUNDING AND BONDING IN AIRCRAFT

## This special edition of *QwikConnect* explores the important topics of grounding and bonding in aircraft.

**Bonding** refers to the practice of electrically connecting various metallic components within an aircraft to minimize differences in electrical potential and prevent the buildup of static electricity. Bonding ensures electrical continuity and equalizes the electrical potential among and between different metallic components. It eliminates potential differences that could cause

electrostatic discharge (ESD), electrical arcing, and ultimately electromagnetic interference.

US Federal Aviation Regulations (FARs) and equivalent European EASA standards govern bonding and grounding in civil aviation. Here are two key paragraphs from the Part 25 FAR on bonding:

### § 25.899 Electrical bonding and protection against static electricity.

- (a) Electrical bonding and protection against static electricity must be designed to minimize accumulation of electrostatic charge that would cause—
  - (1) Human injury from electrical shock,
  - (2) Ignition of flammable vapors, or
  - (3) Interference with installed electrical/electronic equipment.
- (b) Compliance with paragraph (a) of this section may be shown by—
  - (1) Bonding the components properly to the airframe; or
  - (2) Incorporating other acceptable means to dissipate the static charge so as not to

endanger the airplane, personnel, or operation of the installed electrical/electronic systems.

The goal of bonding is to ensure all electrical pathways and circuits within the frame of the aircraft share the same electrical potential. During assembly and maintenance, special loop and resistance testers are used to measure the impedance between metallic elements within the structure of the aircraft—and their flexible bond joints—to hunt down any high-resistance areas within the system. The term electrical engineers use for this shared electrical-potential state is “continuity.” Ultimately, using exacting assembly techniques and testing, a Metallic Bonding Network (MBN) is established throughout the aircraft.

**Grounding** is the process of connecting structural and mechanical elements within the pressurized fuselage of the aircraft to a current return path capable of carrying a

fault current to ground. This current return or ground path is crucial for managing EMI in EWIS and power-feeder cabling by directing excessive electrical energy away from sensitive components to the aircraft's ground reference point, thus protecting the aircraft and its sensitive avionics—as well as its passengers and crew—from electrical hazards.

The key test measurement is again resistance and continuity. But now we are looking at the voltage drop across a complex multi-path network, alternatively called the “Electrical Structural Network.” Whatever the name, the point is that modern aircraft are equipped with a preferred, low-resistance ground path for lightning, EMI and other errant currents to follow, directing them away from critical systems and structures. All designed to mitigate potential damage to the aircraft and its passengers, and reduce the risk of electrical interference leading to system malfunction. The key requirement from FAR 25.581 (Lightning Protection) states,

**§ 25.581 Lightning protection.**

- (a) The airplane must be protected against catastrophic effects from lightning...by
- (2) Incorporating acceptable means of diverting the resulting electrical current so as not to endanger the airplane.

While there is considerable functional and structural overlap between grounding and bonding, we are fundamentally describing two distinct systems within the aircraft. Let's look at both in greater detail.

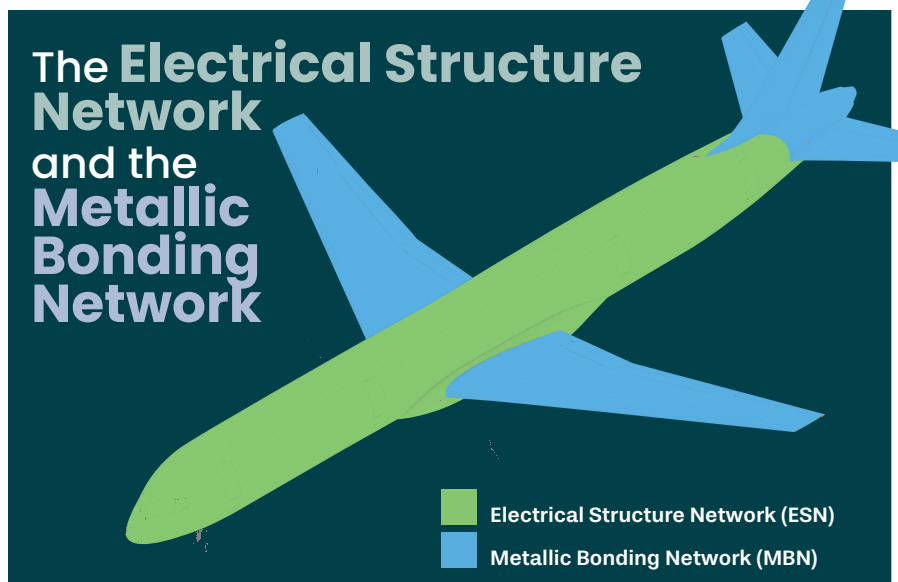

Modern aircraft are equipped with two distinct but interconnected systems, the “Electrical Structure Network” and “Metallic Bonding Network”

The **Electrical Structure Network (ESN) or Current Return Path** refers to interconnected electrical components (metallic frames, racks, ground cables, raceways, flexible joints, and so on) as well as the pressurized fuselage of the aircraft itself. The ESN serves multiple purposes, including

- **Lightning Strike Protection:** The conductive nature of the fuselage allows it to act as a Faraday cage, directing the majority of the lightning current along the exterior of the aircraft, protecting the interior with its passengers and sensitive electronic systems.
- **Grounding:** The ESN serves as the basis for establishing grounding connections throughout the aircraft, particularly for power transmission and EWIS cabling, ensuring that electromagnetic and radio frequency interference is controlled to manageable levels.

The **Metallic Bonding Network (MBN)** refers to the intentional interconnection of various metallic components within the aircraft's extremities (wings, empennage, vertical stabilizer, and so on) to establish low-resistance paths and equalize electrical potentials. The MBN ensures effective bonding between different parts of the aircraft's structure and equipment, particularly for the purpose of ESD mitigation. The MBN helps to eliminate electrostatic discharge events by providing low-resistance paths for static charges to dissipate through the conductive structure via ionization into the environment, or directly to ground via landing gear and conductive rubber aircraft tires.

Faying surface bonding and bond straps (also called “flexible joints”) are used to physically connect metallic and structural components, such as wings, control surfaces, antennas, and static wicks, to establish electrical continuity and equalize electrical potentials. These bonding connections help prevent any build-up of static electricity throughout the aircraft, a critical safety requirement and mitigating factor in the management of electromagnetic interference.

The **ESN and MBN** are integral parts of the overall electrical grounding and protection strategy, working together to provide a reliable electrical environment, mitigate lightning-related risks, and manage EMI. Above all, the two systems are critical to meeting passenger and environmental safety requirements—a fundamental issue for all aircraft, but one of particular concern to eVTOL vehicles which must implement even more stringent grounding procedures to effectively ground HV batteries, controllers, and motors for passenger as well as ground crew protection.

# Bonding in AIRCRAFT SYSTEMS

As stated, bonding helps mitigate electromagnetic interference (EMI) and radio frequency interference (RFI) by providing a common electrical reference point for all bonded components. It reduces the risk of stray currents and minimizes the impact of electromagnetic fields. Bonding also contributes to the mechanical stability and integrity of the aircraft.

In an aircraft fuel system, for example, bonding is crucial to prevent static electricity buildup and discharge. Metallic components, such as fuel tanks, pipes, and fittings, are bonded together using a process called "faying surface preparation" as well as through the use of auxiliary bonding conductors or straps (flexible junctions made of plated copper braid material). This approach equalizes electrical potential, minimizing the risk of sparks

and potential ignition sources in fuel-rich environments.

Faying surface preparation for bonding between two metallic surface is a labor-intensive process which joins metallic components and structures within the aircraft into a vibration- and movement-resistant network of mechanical and electrical bonds.

The process involves removing any protective coatings, paint, or corrosion layers from the mating surfaces to expose bare metal. The surfaces are then cleaned to remove dirt, grease, or other contaminants that could hinder the bonding process. Various methods may be used for faying surface bond preparation, including abrasive cleaning, chemical cleaning, or mechanical methods like scraping or wire brushing.

Once the faying surfaces are properly prepared, they are bonded together using fasteners, adhesives, as well as a surface sealant. This ensures both a strong mechanical connection and a low-resistance electrical bond between the

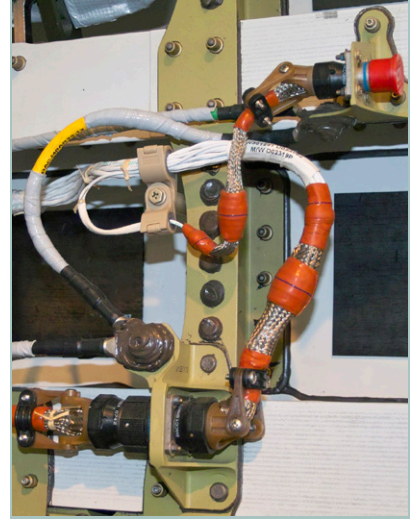

**Adhesive and sealant protected faying surface bonding of mechanical structures. Note cable shielding and auxiliary flexible joints (ground straps) used to ensure common electrical potential.**

components, facilitating proper bonding and electrical continuity throughout the aircraft.

The sealant used in the faying process serves several purposes, including ensuring a watertight and airtight joint, preventing corrosion, and enhancing the structural integrity of the bonded components. Faying process sealants are similar in function to the polysulfide sealant used in Glenair Series 440 banding adapters to prevent galvanic corrosion between the shell and the conductive braid screen. The choice of sealant depends on the specific requirements of the application, such as temperature, pressure, environmental conditions, and the materials being bonded.

It is important to note that while faying surface bonds contribute to electrical continuity, they may not prove sufficient in all cases—particularly in aircraft zones subject to expansion and contraction of the fault current ground path. For this reason, auxiliary braided jumper ground straps and studs (flexible joints) are used in addition to faying surfaces to further establish reliable and low-resistance electrical

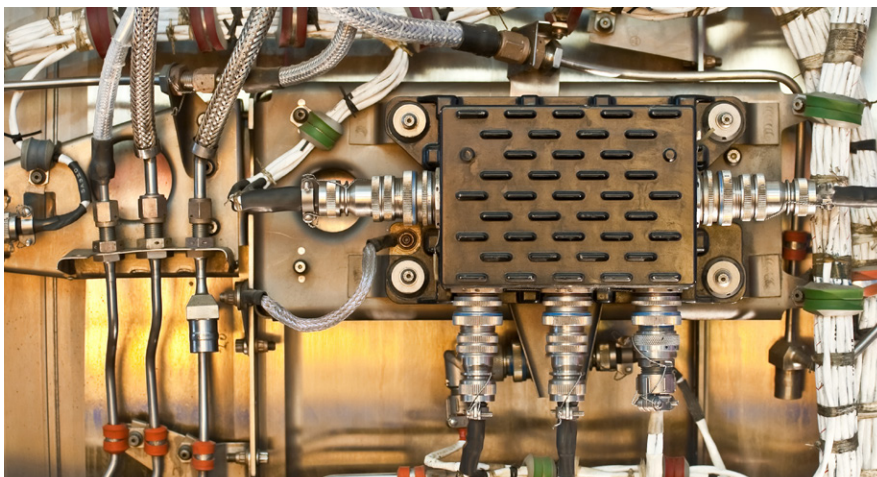

**Bonding and grounding involves the use of galvanic finishes, faying surface preparation of mating metallic parts, the use of compatible structural fasteners and sealants, and flexible joints (ground straps).**



connections. These additional bonding components are used throughout the MBN, especially when connecting components are subject to conditions of high vibration or movement, such as in aircraft wings.

Critical equipment such as sensors and communications antenna often employ both faying surfaces and auxiliary ground straps to ensure robust dissipation of electrostatic energy. The use of multiple bonding methods provides redundancy and helps maintain reliable electrical connections, essential for the proper functioning and safety of passengers as well as avionic and other mission-critical systems.

## Bonding and EMI Mitigation

Electromagnetic interference (EMI) refers to the disturbance caused by unwanted electromagnetic fields that can negatively impact the performance of electronic systems. Bonding in aircraft systems plays a vital role in mitigating EMI in the following ways:

**Establishing Common Reference Points:** Bonding connects metallic components to a common electrical potential, minimizing resistance differences between conductive components, and thereby reducing the generation of static electricity that may potentially ground to EWIS wiring in the form of EM or RF interference.

**Forming EMI Shielding Paths:** Shielding techniques, such as EWIS cable screens and cable bay enclosures, create effective EMI shielding paths, which help direct and dissipate electromagnetic fields away from sensitive electronic components, minimizing their impact. This is accomplished by bonding these EWIS components to the MBN.

**Minimizing Ground Loops:** Proper bonding techniques help prevent the formation of ground loops. By ensuring that interconnected components have low-resistance connections to obtain near-perfect ground potential, bonding reduces the circulating currents

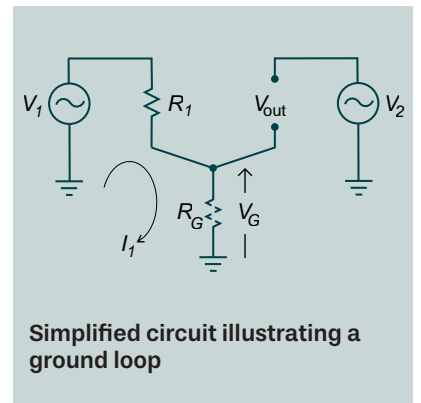

that can cause ground loops, further minimizing EMI risks.

**Electrostatic discharge:** A final additional consideration in bonding's role in EMI mitigation is the facilitation of safe electrostatic discharge from aircraft wings and other extremity surfaces which accumulate a buildup of static electricity from friction contact with air, rain, or dust. A static discharge system consisting of components known as static dischargers, or static wicks, is fitted in the trailing edges of the wings to discharge the buildup of static electricity on the airframe safely into the atmosphere (see sidebar for more information).

In summary, bonding in aircraft systems plays a vital role in ensuring electrical continuity and mitigating EMI. It helps establish electrical continuity between components, creates low-resistance paths for current flow, and enhances the effectiveness of grounding systems. Additionally, bonding techniques contribute to EMI mitigation by establishing common electrical reference points, forming ESD dissipation paths, and minimizing the formation of ground loops—essential for maintaining electrical integrity, optimizing system performance, and ensuring the reliable operation of aircraft systems.

**Transient Voltage Suppression (TVS) Connectors** are another tool used to protect mission-critical avionic equipment by clamping and diverting excessive energy to ground.



## CURRENT RETURN PATH or Electrical Structure Network (ESN)

The ESN is a passive metallic grounding network made up of thousands of structural elements of the airframe as well as additional conductive components—including ground straps and cables—bonded together and connected to the aircraft's overall grounding / bonding system. As described in the sidebar, the key function of the network—particularly from the perspective of regulatory agencies—is passenger and crew protection from lightning strike or other surge-currents. The ESN also plays a crucial role in mitigating EMI by helping to direct errant electrical energy away from sensitive systems, again, ensuring the safety of the aircraft and its occupants.

## Grounding Principles

Grounding in aircraft systems is based on the implementation of several fundamental electrical principles:

**Point of Voltage Reference (PVR):** The PVR in aircraft systems is the zero volt reference shared by all aircraft equipment. The neutral of the aircraft's alternating current (AC) power sources, and the cold point of the aircraft's direct current (DC) sources, are electrically connected to the PVR, serving as a common reference for electrical potential. The PVR is connected to the Earth's ground during refuelling and ground maintenance, providing a stable and consistent fault current grounding path.

**Equipotentiality:** The principle of equipotentiality ensures that all metallic components that can be touched simultaneously, or can come into contact during normal operations, are electrically bonded

## Mission-Critical SYSTEMS

Here are some examples of mission-critical systems isolated and protected from voltage surges by the current return path (Electrical Structure Network)



**Flight Control Systems:** These systems, including fly-by-wire control surfaces and related components, are vital for maneuvering and navigating the aircraft during flight. Ground system surge protection is crucial for uninterrupted control and helps prevent fault current malfunctions that could jeopardize flight safety.



**Avionics Systems:** Avionics encompass a wide range of electronic LRUs, including communication, navigation, and flight management. Avionics provide essential data and functionality for flight operations. Surge protection in avionics equipment helps safeguard sensitive electronics, prevent data corruption, and ensure accurate functioning of critical instrumentation.



**Power Distribution Systems:** The power distribution system supplies electrical power for all critical operations on the aircraft. Surge protection is necessary to prevent voltage spikes from interrupting power supplies and damaging electrical equipment on increasingly all-electric aircraft.

together to maintain the same electrical potential. This minimizes the risk of potential differences and reduces the chance of electrical arcing or interference. Both the ESN and the MBN are engineered to achieve equipotentiality.

**Low Impedance:** Grounding conductors should have low impedance to facilitate the flow of fault currents and provide a path of least resistance for electrical energy. Low-impedance grounding ensures effective fault current diversion and minimizes voltage differences between components.

**Functional Grounding:** Functional grounding refers to the intentional connection of components or systems to a common reference point or ground to ensure proper functioning of the electrical system. It establishes a consistent electrical potential for components that require a shared ground reference. Functional grounding is essential for stable

operation, signal integrity, and system performance. For example, functional grounding is employed in avionics systems, where various components, such as displays, navigation equipment, and communication systems, are connected to a common ground reference. This ensures proper functioning, accurate data transmission, and interference-free operation.

**Fault Grounding:** Fault grounding, also known as protective grounding or safety grounding, involves the intentional connection of conductive components to the ground to facilitate the safe dissipation of fault currents. Fault grounding protects against electrical faults, such as short circuits or equipment failures, by providing a low-resistance path for fault currents to flow to the PVR (point of voltage reference). Fault grounding ensures that excessive electrical energy is diverted safely to the ground, preventing damage

to the system and reducing the risk of electrical hazards.

**Lightning Grounding:** Lightning grounding is a specialized form of grounding that focuses on protecting aircraft from the effects of lightning strikes. It involves the use of conductive paths and structures designed to intercept lightning energy and direct it safely to the ground. Lightning grounding systems help protect critical components, minimize electromagnetic interference, and reduce the risk of localized structural damage caused by lightning. Lightning grounding systems may include lightning conductors or rods strategically placed on the aircraft structure, such as on the nose or leading edge of wings. In addition, bonded metallic components may be integrated into the outer skin of the aircraft. These grounding conductors are all specifically designed to handle high-energy lightning currents.

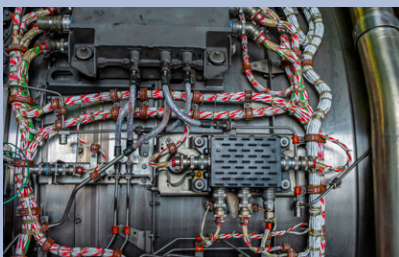

**Engine Control Systems:** Engine control systems, including electronic engine control units (ECUs) and FADECs, monitor and regulate engine performance, fuel injection, and other critical parameters. Surge protection is crucial to ensure uninterrupted engine operation and prevent potential damage to engine control components.



**Fuel Management Systems:** Fuel management systems monitor and control the fuel supply to engines and auxiliary power units (APUs). Surge protection is vital in these systems to prevent voltage transients from causing fuel flow disruptions or interrupt data sensor information critical to pilot decision-making.



**Environmental Control Systems:** HVAC systems regulate cabin temperature, pressurization, and ventilation. Surge protection helps maintain the proper functioning of environmental control components, ensuring passenger comfort and safety.

## DIRECT BONDING

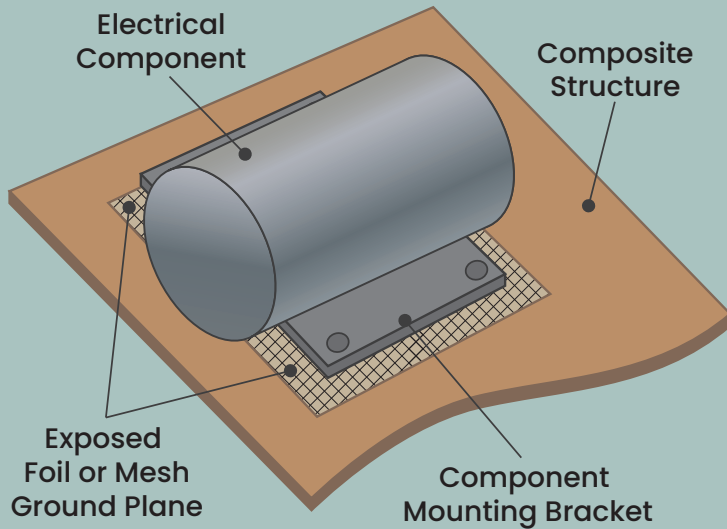

## INDIRECT BONDING

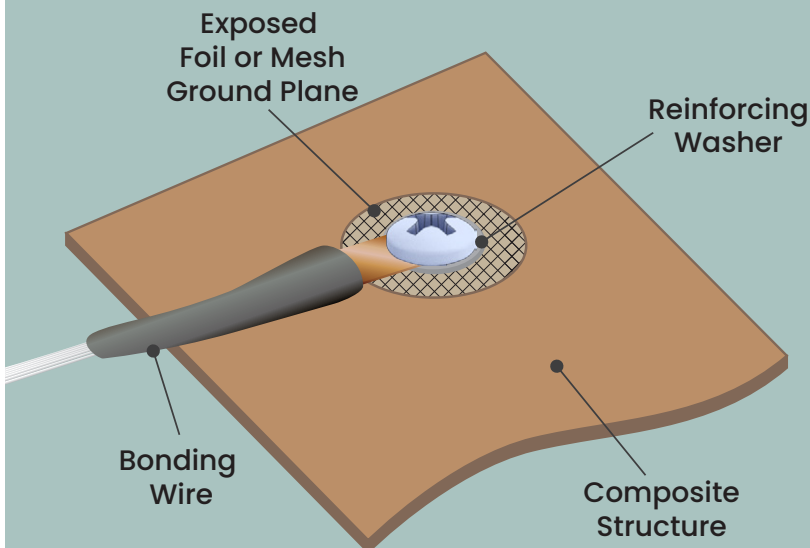

## Electrical Bonding in Composite Aircraft

In aircraft construction, composite materials offer improved strength-to-weight ratio compared to aluminum. However, these materials exhibit high electrical resistance and inhibit bonding, earth returns, and lightning strike dissipation. This lack of electrical conductivity requires integrating a ground plane into the composite airframe. Typically, an expanded copper foil or wire mesh (or other high-conductivity material) is bonded into the composite structure during the manufacturing process and can be accessed at key points throughout the aircraft.

Direct bonding (top) involves exposing the foil or mesh—the ground plane—and mounting equipment onto the conductive path. Comparatively, indirect bonding (bottom) requires installing a bonding wire and connector onto the exposed foil or mesh. After establishing the connection, the mesh must be coated to prevent the aluminum from oxidizing when exposed to air. Oxidation will compromise joints and increase electrical resistance.

To protect a composite aircraft from lightning strike, aluminum wire is integrated into the outer layers of the composite construction. This integrated wire construction offers fixed exit routes which dissipate the lightning strike across the extremities of the aircraft.

## The Anatomy of ESN Lightning Strike Technology

Lightning usually strikes an aircraft on the nose or other extremity points such as wing-tips or the vertical stabilizer. For this reason, the aircraft nose and other extremity edges are generally equipped with lightning diverter strips to arrest the current and dissipate it across the fuselage. The aluminum or conductive composite fuselage of the aircraft is an integral part of the ESN and conducts the discharge along the outer surface of the aircraft to an exit ground point. The fact that all this occurs without serious damage to the aircraft or injury to its passengers is because the fuselage is a highly-engineered Faraday cage.

A Faraday cage is an enclosure made of conductive material that is designed to block external electromagnetic fields. As stated, the aircraft fuselage is primarily made of conductive materials, such as aluminum or composite thermoplastic with conductive layers. These materials have low electrical resistance and allow for effective conduction of electric charges. When a lightning strike occurs, the conductive structure of the fuselage provides a low-resistance path for the lightning current to flow around the exterior of the aircraft. This means that the majority of the lightning current will flow through the external conductive structure rather than entering the aircraft's interior.

As the lightning current flows over the outer surface of the plane, its energy is distributed across the conductive structure. This helps to prevent concentrated current paths that could lead to localized damage, reducing the risk of structural or equipment failure.



# STATIC DISCHARGE WICKS

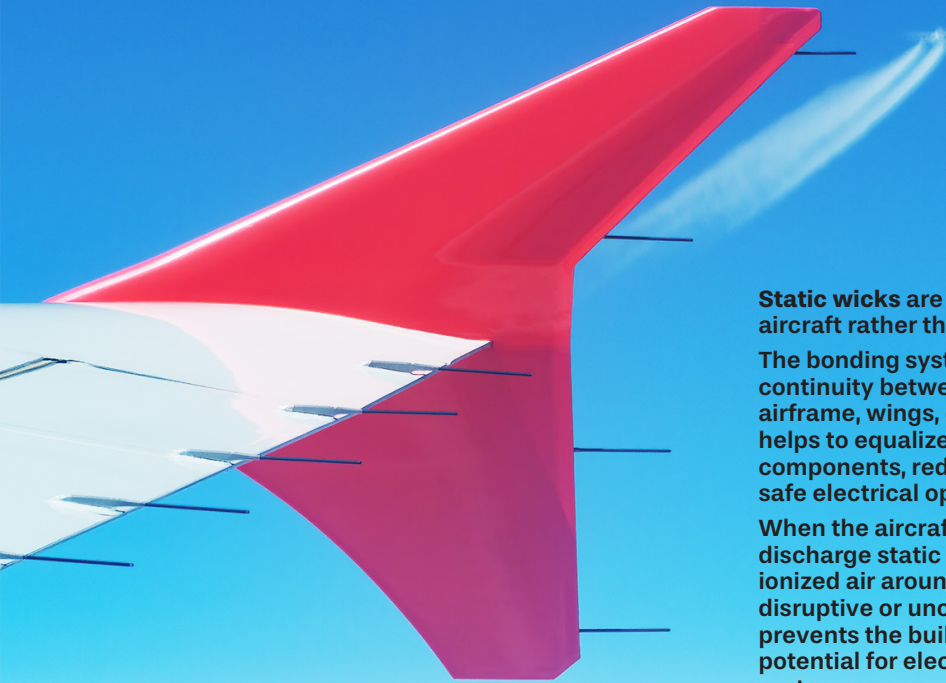

**Static wicks** are considered a part of the "bonding" system on an aircraft rather than the "grounding" system.

The bonding system in an aircraft is designed to ensure electrical continuity between various metallic components, such as the airframe, wings, control surfaces, and other conductive parts. It helps to equalize the electrical potentials between these components, reducing the risk of static discharge and promoting safe electrical operation.

When the aircraft is in flight, static wicks help to dissipate or discharge static electricity by providing a point of ionization. The ionized air around the wick helps to minimize the potential for disruptive or uncontrolled discharges. This discharge path prevents the buildup of excessive static charge and reduces the potential for electrical interference with aircraft communication systems.

## Static Wicks

Static wicks, also known as static discharge wicks or static dischargers, are devices installed on the trailing edges of aircraft surfaces, such as wings, vertical stabilizers, or antennas. These devices are designed to manage and dissipate static electricity buildup that occurs naturally on wings and other external surface in order to minimize the risk of a larger electrical discharge.



Lightning diverter strips on the nose of an airplane

Static wicks consist of conductive materials, such as metal or carbon fibers, that provide a controlled path for static charges to dissipate into the surrounding air. By regularly discharging the static electricity, the wicks both help reduce the likelihood of a lightning strike as well as mitigate the buildup of potentially damaging electrical charges on the aircraft's surfaces.

In the event of a lightning strike, static wicks pull double-duty as the lightning discharge point, returning the surge current back into the atmosphere.

## Composite Structures:

Composite structures, commonly used in modern aircraft, and in the emerging eVTOL industry, pose unique challenges for grounding and bonding due to their inherently poor conductivity. During the manufacturing process of composite structures, provisions must be made for lightning strike dissipation and equipment bonding.

Typically this involves incorporating metallic foils, meshes, or embedded conductive paths within the composite material layers to reproduce the Faraday cage behavior of an aluminum fuselage. In addition, conductive elements, such as bonding straps or wires, are used to create electrical continuity between different production breaks (if any) within the composite structure. Finally, composite aircraft incorporate metallic attachment points, such as brackets or threaded inserts, for the mounting and grounding of equipment. The electrical bonding via metallic attachments to the aircraft's Electrical Structure Network establishes electrical continuity and minimizes potential differences between conductive composite elements and metallic components.

Conductive elements within the composite structure—again, sub-surface foils and conductive strips—provide a pathway for electrical currents to flow and establish equipotentiality.

## TROUBLESHOOTING of Grounding and Bonding ISSUES:

**Visual Inspection:** Visual inspection is the initial step in troubleshooting grounding and bonding issues. It involves inspecting bonding connections, grounding conductors, and bonding points for physical damage, loose connections, corrosion, or improper installations. Visual inspection can often provide clues about potential issues that require further investigation.

**Fault Isolation:** If a grounding or bonding issue is suspected, fault isolation techniques are employed to identify the specific location or component causing the problem. This may involve selectively isolating or disconnecting different parts of the grounding or bonding system and performing resistance tests to identify the faulty component.

**Resistance Testing:** Loop and joint resistance measurements are commonly used during troubleshooting to identify high-resistance or open-circuit conditions in bonding conductors or grounding connections. By measuring

the end-to-end resistance of flexible bond joints, deviations from expected values can indicate potential issues that require immediate maintenance.

Effective loop, grounding, and bonding test procedures and troubleshooting techniques are essential for maintaining the integrity and functionality of aircraft electrical systems. These practices help ensure compliance with regulatory requirements, identify and rectify potential issues, and guarantee the safety and reliability of the aircraft's electrical infrastructure.

## GROUNDING on Earth and in Flight



The ground system and Faraday cage/shield of an aircraft is designed to equalize electrical potential and provide a path to "ground" for electrical surges or spikes impacting aircraft during refuelling and other Turn-Around-Time activities on the ground. But what about when the aircraft is in flight? How does this same system help to protect the aircraft's electrical systems, equipment, and occupants from electrical faults, surges, and potentially damaging lightning strikes without direct contact to the earth?

During flight, the aircraft's grounding system does not rely on a direct connection to the Earth as it does during Turn-Around-Time operations. Instead, it utilizes the low-resistance, conductive skin of the aircraft, augmented with lightning protection system components (arrestors, conductive strips, ground straps, and so on) to channel the discharge to aircraft extremities where it may be returned harmlessly to the atmosphere. Static wicks (see sidebar) aid in the safe discharge of both static electricity as well as these higher-power electrical currents.

# ESD and Lightning Strike in eVTOL Aircraft

Electric Vertical Takeoff and Landing (eVTOL) aircraft, which are designed for urban air mobility and powered by HV electric propulsion systems, have unique requirements for Electrostatic Discharge (ESD), grounding, and lightning strike protection and dissipation. These requirements arise due to the unique characteristics and vulnerabilities of electrically powered aircraft.

Effective bonding and grounding is crucial for eVTOL aircraft to mitigate the risk of electrostatic discharge, which can impact sensitive electronic components and systems. Electric propulsion systems generate static electricity during their operation, and without proper grounding, accumulated current can discharge unexpectedly, leading to electronic equipment malfunctions. Adequate grounding measures are implemented to ensure a controlled dissipation of static electricity or fault current events and prevent interference in the aircraft's avionic and control systems. There are four principal areas of focus in eVTOL bonding and grounding:

1. **Equipment Grounding:** eVTOL aircraft are constructed from composite materials, such as carbon fiber-reinforced polymers, for their lightweight and high-strength properties. These materials are electrically conductive thanks to the addition of subsurface layers of conductive foil, but must also incorporate additional conductive elements within the composite structure to ensure proper ground points and paths for effective grounding and bonding of aircraft equipment.
2. **Lightning Diversion and Dissipation:** Lightning poses a significant risk to all aircraft, including eVTOL designs. As lightning strikes occur most often during the climb

and descent phases of flight at an altitude of 5,000 to 15,000 feet (1,524 to 4,572 meters), the probability of a lightning strike in eVTOL aircraft operating exclusively at these altitudes is relatively higher. Lightning protection systems in eVTOL aircraft mimic those employed in conventional aluminum airframe platforms, and involve a combination of conductive paths, bonding, and lightning diverters. Defined pathways safely conduct lightning energy across the composite skin of the aircraft, minimizing the likelihood of localized damage. Additional lightning dissipation devices, such as static wicks, are installed to facilitate the safe dissipation of the electrical energy.

3. **Electrical System Shielding:** HV Power transmission cabling in eVTOL aircraft should be adequately shielded to prevent electromagnetic interference (EMI) from radiating and grounding to low-power signal lines and cabling. Shielding measures include the use of overbraided cable shielding, auxiliary flexible ground straps, and faying surface preparation between metallic elements of the power transmission and motor propulsion system.
4. **High-Voltage Fault Grounding:** Creating an "Equipotential Zone" (EPZ) is a precautionary measure followed to de-energize and ground equipment in eVTOL for personnel safety. It is a "lock out, tag out" procedure required before any high-voltage equipment (batteries, controllers, motors) are accessed for maintenance. The procedure could extend to any personnel, including first responders, who might come in contact with high-voltage power equipment on the aircraft—even in a powered-down state—that could still carry a charge and constitute a shock hazard.

# BRAIDED GROUND STRAPS • FLEXIBLE JOINTS

## The ABCs of Flexible Braided Jumper GROUNDING STRAPS

Electrical Structure Network and Metallic Bond Network ground strap material selection depends on electrical resistance, current, and EMI shielding requirements, as well as environmental and regulatory standards. The following configurations have been fully tested and qualified. Consult factory for additional material options.



**Tin-plated copper** material is commonly used in most aerospace applications, and combines the excellent conductivity of

copper with the good corrosion resistance of tin plating.



**Silver-plated copper** may be selected for applications where highest conductivity and excellent resistance to corrosion are required.



**Nickel-plated copper** is selected for excellent conductivity and best corrosion protection of the copper-plated material types.



Finally, **stainless steel** is the most durable and corrosion-resistant material and should be selected for applications where high strength and resistance to environmental factors such as high heat, moisture, and salt are required. Stainless steel however is not as conductive as any of the copper-core material types.

**Conductive and dissipative materials** such as copper, are selected for their low resistance while dissipative materials such as steel are selected for their ability to discharge electromagnetic energy in the form of heat. The selection of the correct mix of conductive and dissipative materials for ground straps in aircraft depends on multiple factors including durability, weight and space requirements, as well as galvanic compatibility with other materials. Industry standards also dictate material selection for use in aircraft ground straps.



**Ground lug styles and types** include square and radiused with variable mounting hole sizes, as well as single or double right-angle lugs. Ground straps may be supplied with and without insulation materials, depending on their proximity to heat-sensitive equipment such as unshielded wire looms.



**ArmorLite™:** Uniquely available from Glenair, ArmorLite is an additional material choice for use in grounding and bonding. ArmorLite is a nickel- or silver-clad stainless steel micro-filament material that saves significant weight compared to standard QQ-B-575 materials such as soft-drawn silver- and tin-plated copper.

A 100% ArmorLite ground strap, for example, is more than 70% lighter than a conventional plated copper jumper of the same length.

ArmorLite ground straps are supplied in different material blends optimized for conductivity and corrosion resistance. ArmorLite at 100% is the lightest weight of the four available blends. The 75/25 and 50/50

blends of ArmorLite and nickel copper improve ground strap conductivity at the cost of some additional weight. ArmorLite CF is a special construction of highly conductive copper microfilaments with stainless steel cladding which offers optimal corrosion resistance and conductivity.

As stated earlier, ArmorLite is preferred for applications that require weight reduction. For standard-duty ground straps in applications where weight reduction is not a critical requirement, Glenair supplies A-A-59569 soft-drawn braided material ground straps in tin-plated copper, silver-plated copper, nickel-plated copper, and stainless steel.



For in-stock catalog ground straps, as well as custom solutions, Glenair offers aerospace customers a wide range of industry-standard, QPL, and Glenair Signature designs and materials. Catalog ground straps are supplied with crimp copper or stainless steel lugs, single and double mounting holes, a full range of qualified braid materials (and off-menu choices), dimensional variations, and high surge-current configurations.



## Total Vertical INTEGRATION

In-house manufacturing of ground straps is another total vertical integration manufacturing process at Glenair. For standard-duty ground straps, the process begins with the manufacture of QQ-B 595 braided strap material and the preparation of conductive lug materials. A hydraulic press is used to terminate the flattened tubular lug material to the braid. Mounting holes are drilled, and the lug is selectively plated.

Glenair lightweight ArmorLite ground straps are built around a low-profile lug that is soldered to the ground strap in a controlled and repeatable process. The use of a discrete solder strip and the application of heat ensures a low-resistance termination between strap and lug.

Electrical engineers may begin the downselect process at any number of points including electrical, mechanical, and environmental. Mechanical form-factor decisions include configuration of lugs—straight or right angle—basic dimensional details, and attention to space constraints, particularly proximity to equipment and strap flexibility. Corrosion resistance is a critical concern in ground straps, and may dictate compromises in braid and lug material selection as well as plating. ASTM and other standards will often dictate exact material selec-

tion for ground straps used in different aircraft zones.

As is always the case in power and grounding systems, only the customer can determine current-carrying requirements for each ground point. Ground straps connected to power generation equipment, for example, would typically be specified to handle larger surge load requirements than a ground point design to dissipate electrostatic energy. These factors influence the selection of single vs. multiple braid layers and lightweight versus heavy-duty braid material.

Insulation jacketing is commonly specified on ground straps in corrosive zones where exposure to caustic chemicals such as jet fuel or deicing liquids is anticipated. Viton is a common insulation choice. Glenair can supply Viton per MIL-DTL-23053/13B on both standard duty as well as lightweight, low-profile ground straps. Duraelectric, with its excellent UV resistance is also available as an alternative jacketing material.

Glenair mission-critical ground straps are highly engineered solutions, designed to meet the exacting requirements of sea, air, and space applications. These highly-engineered solutions utilize materials and design standards optimized for superior mechanical, environmental, and electrical performance. Like all Glenair product families, Series 107 ground straps are a high-availability product line, with all popular part numbers in various lengths in same-day inventory. We offer fast turnaround on quotes for catalog and custom designs, and first article inspection if required. Test data is available.

# Bond WORD LADDER

to the word at the bottom, filling each of the braid strap rungs with a new word along the way.

Change one letter at a time—but not the position of any letter—to form a new word. The goal is to transition from the word at the top of the ladder to the word at the bottom, filling each of the braid strap rungs with a new word along the way.

L	O	S	S
L	O	S	T
L	O	O	T
L	O	O	N
L	O	I	N
L	A	I	N
G	A	I	N

S	T	A	R	T
C	E	A	S	E

B	R	A
C	O	

N	I	N	E
F	O	U	R

F	O	O	L
W	I	S	E

S	T
T	W

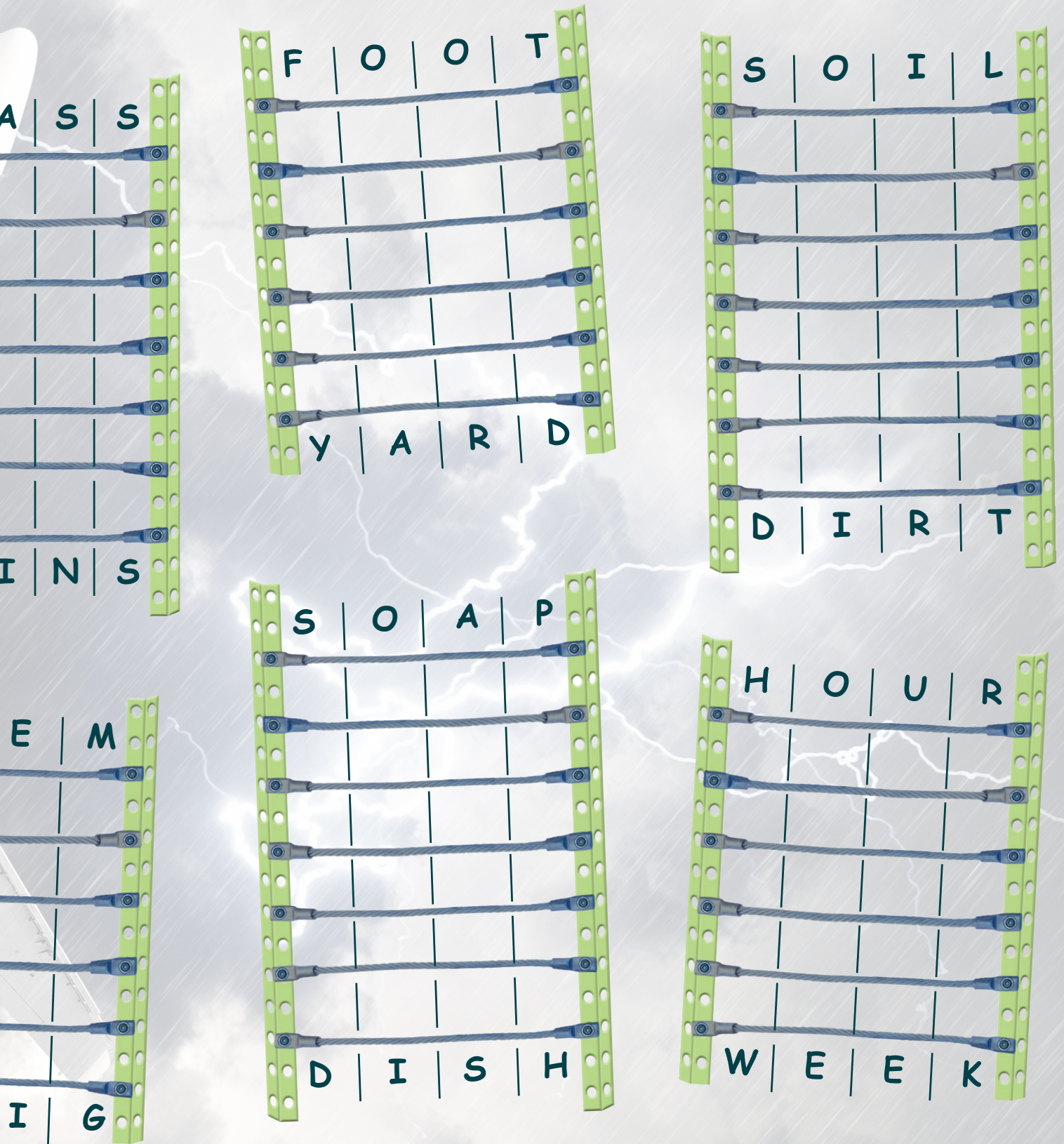

answers: [www.glenair.com/qwikconnect](http://www.glenair.com/qwikconnect)

Lightweight flexible joints (ground straps) for electrostatic discharge bonding and electrical structure network grounding



2-ply ground straps provide superior bonding and flexibility

Ground straps and earth bonds are critical components in all aerospace as well as many land, sea, and space applications. They are used to establish reliable electric connections, ensure safety, and prevent the buildup of electrical charges. This helps provide a common ground reference for the equipment and ensures proper functioning against electromagnetic interference.

Glenair supplies a complete range of flexible bond and grounding solutions including lightweight ArmorLite braided ground straps as well as standard duty and mil-qualified designs.

- Ultra-lightweight and standard-duty ground straps with highly conductive or dissipative performance
- Heavy-duty variants for electrical potential grounding from engines, starters, and power units
- Glenair signature and qualified military standard designs

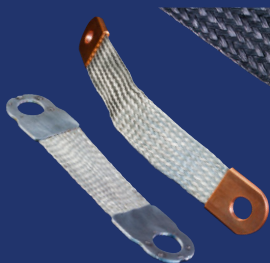

Hybrid braid materials and customizable lug material options

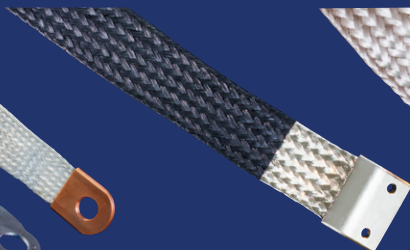

Specialized lug configurations including integrated bonding hardware and angled lugs

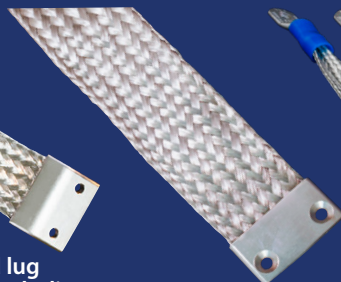

Heavy-duty braid and lug configurations



Round cross-section braid



Harsh temperature and chemical-resistant ground strap jacketing



Lightweight, general, and mil-spec designs

### THE ARMORLITE ADVANTAGE

Lightweight microfilament braided ground straps

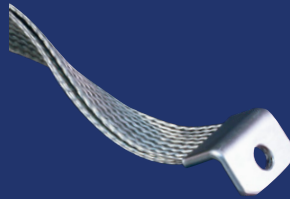

- 107-105 100% ArmorLite, our lightest weight braid
- 107-106 75% ArmorLite 25% Nickel Copper weight-saving conductive blend
- 107-107 50% ArmorLite 50% Nickel Copper weight-saving conductive blend
- 107-108 ArmorLite CF High-performance corrosion-free lightweight braid

### STANDARD-DUTY GROUND STRAPS

A-A-59569 soft-drawn braided ground straps

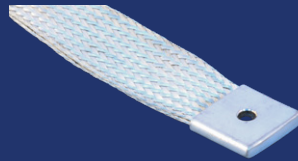

- 107-101 Tin copper material ground straps
- 107-102 Silver copper material ground straps
- 107-103 Nickel copper material ground straps
- 107-104 Stainless steel material ground straps

### MIL-SPEC GROUND STRAPS and BOND STRIPS

and Glenair Signature designs with "better than mil-spec" configuration options



- M24749 Type I wire rope ground strap
- M24749 Type II flat CRES 316 strip bond strap
- M24749 Type III flat copper strip bond strap
- M24749 Type IV CRES 316 / Nickel 200 ground strap
- 107-500 M24749-IV style with configuration options
- 107-501 M24749-I type with lug hole size and length configuration options
- 107-502 M24749-II type with configuration options
- 107-503 M24749-III type with configuration options
- 107-504 M24749-IV type with lug hole size and length configuration options

### TURBOFLEX WIRE ROPE STRAP

High flexibility



- 107-111 TurboFlex ultra-flexible rope-lay wire rope grounding straps and lugs

### BUS BAR GROUND STRAPS

Heavy-duty high-current ground straps

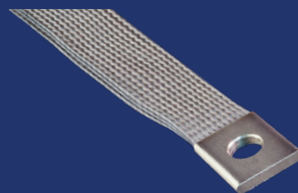

- 107-277 Single-layer, 30AWG, braided bus bar
- 107-278 Double-layer, 30AWG, braided bus bar
- 107-435 Triple-layer, 30AWG, braided bus bar
- 107-436 Quad-layer, 30AWG, braided bus bar

### SUBMARINE GROUND STRAPS

IAW A-A-59569

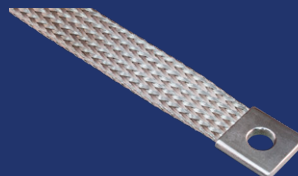

- 107-086 Low-profile nickel-plated copper braid materials IAW ASTM B 355

# LIGHTWEIGHT **ARMORLITE™**

Microfilament nickel-clad expandable stainless steel conductive braid material



ArmorLite™ is an ultra-lightweight microfilament stainless steel braiding material fabricated by Glenair into various forms of sleeving, shielding, and ground straps for EMI, lightning strike, and ESD applications



Save weight and fuel every time you fly! All-Up-Weight (AUW) has met its match: ArmorLite™ microfilament stainless steel braid material saves pounds compared to standard QQ-B-575/A-A-59569 solutions. Braided into cable shielding or ground straps, ArmorLite™ is a high-performance, high-strength, conductive stainless steel material ideally suited for use in aerospace applications. The principal benefit of ArmorLite™ is its extreme light weight compared to conventional nickel/copper braid material. By way of comparison, 100 feet of 5/8 inch ArmorLite™ braid is more than four pounds lighter than standard 575 A-A-59569 shielding. The ArmorLite braided ground straps in this catalog demonstrate outstanding performance in both ESD and lightning strike testing. Consult factory for complete test reports.

- **Ultra-lightweight EMI/RFI braiding material** for high-temperature applications -80°C to +260°C
- **Microfilament stainless steel: 70% lighter** than NiCu A-A-59569/QQB575
- **Outstanding electrical performance:** shielding, conductivity, and grounding
- **Commercial and military aerospace qualifications**
- **Superior flexibility** and “windowing” resistance
- **Strong: 70,000 psi (min.)** tensile strength
- **Best performing metallic braid** during lightning tests (IAW ANSI/EIA-364-75-1997 Waveform 5B)

# LIGHTWEIGHT, FLEXIBLE ArmorLite™ Microfilament Braid

## for EMI/RFI Grounding Applications

ArmorLite™ Material Performance Test Matrix			
DESCRIPTION	REQUIREMENT	PROCEDURE	REPORT
Altitude test 27,000 ft (5 PSIA nom.)	2.5% min.	RTCA DO-160F, Table 4-1, Table 4-2 Category C temp. spec	ARM-103
Operating Temperature	-80°C to +260°C	(Shielding effectiveness 1000 hours)	ARM-103
Braid Resistivity test, Pre and Post	Test pre/post-5 cycles-minimal disparity per spec.	EIA-364-32D IAW AS85049	ARM-110/1
Surface Transfer Impedance	Transfer Impedance (10.0 kHz ~ 1.0 GHz)	IEC 62153-4-3 min. 90% optical coverage	GT-17-263
Shield Effectiveness test, Pre and Post	Screening Attenuation (0 ~ 4.00 GHz)	IEC 62153-4-4 min. 90% optical coverage	GT-17-263
Tensile/ Pull Strength	220 lbs. (min.). No anomalies within 8% - 10% of pre test for variable sizes	Glenair ATP- 183. 0 lbs. to 90 lbs, to 150 lbs, to 220lbs @ speed of 0.25 inches/min	ARM-105
Specific Gravity Test	8.2 (max) per ISO-1183	ASTM A580 (ref 316L Stainless Steel)	ARM-109
Lightning Current Test	Glenair Qual. Test Plan 191/ DC resistance/ voltage criteria per DO-160F Level for 3 sizes up to 30Ka.	ANSI/EIA-364-75-1977 Wave Form 5B SAE/ARP5416 Section 6.3 Waveform 1, 3 (1, 10MHz) and 5A	ARM-110 ARM-112
Vertical Flammability	Self extinguishing ≤ 2 sec. Burn length 0.1 inch. max. Dripping 0.0 seconds.	14 CFR part 25.853 (a) AMdT25-116 Appendix F Part I (a) (1) (ii)	ARM-101
Mass Loss and Collected Volatile Condensable Materials	Total Mass Loss (TML) ≤1.0% Collected Volatile Condensable Matl.(CVCM) ≤.1%	ASTM E-595	ARM-102
Salt Spray Test	DC Resistance IAW AS85049 .5 milliohm. No evidence of base metal on braid	ASTM B117-09 Sodium Chloride 5% 500 hrs.	ARM-100
Vibration Resistance	EAI Test Report 33247. DO160 section 8 Cat. R Vib. Curves E1	DO-160F RTCA/DO-160F, Section 9, Fig. 8-4. Curve E1. - 3 sizes – 3 hours on each axis.	ARM-111
Thermal Shock Cycling test and Resistivity	No adverse effects in visual inspection or resistance after 50 cycles	EIA-364-32D, Table 3 Test condition V -65°C to +175°C	ARM-113
Abrasion and Plating test	DC Resistance IAW AS 85049. Glenair internal QTR-003	ATP 180 20 continuous @ 6 cycles/min. over 3 arms with .030 radiused edges	ARM-107
Fluid Immersion Test	Material compatibility – see table below	Customer/AS4373D method 601 Mod	ARM-106
Flex Test	2 Cycles: starting 0° over vertical ctr. line across to 180° cycle. Total cycles of 25633	Glenair ATP 179	ARM-112

ArmorLite™ Material Fluid Resistance Testing						
Test Fluid	Test Temp °C	Test Temp °F	Immersion Time(h)	Requirement	Procedure	
MIL-L-23699, Lubricating Oil, Aircraft Turbine Engine, Synthetic Base	48-50	118-122	20	No fraying, DC Resistance within limits (AS85049 paragraph 4.6.3)	SAE AS1241 Table 15/Mil-Std 810F Method 504 (modified), for all Substances. Additional conformance to Test Criteria AS4373D method 601 Mod	
MIL-H-5606 (Inactive for New Design), Hydraulic Fluid, Petroleum Base, Aircraft Missile, and Ordnance	48-50	118-122	20			
TTI-I-735, Solvent, Isopropyl Alcohol	20-25	68-77	168			
ASTM D 1153, Methyl Isobutyl Ketone (For use in organic coatings)	20-25	68-77	168			
MIL-DTL-5624 , Turbine Fuel, Aviation, Grade JP-4 either or MIL-T-83133, JP-8	20-25	68-77	168			
SAE AMS1424, Anti-Icing and Deicing-Defrosting Fluid, undiluted	48-50	118-122	20			
SAE AMS1424, Anti-Icing and Deicing-Defrosting Fluid, diluted 60/40 (fluid/water) ratio. Supersedes Coolanol 25 Item Q	48-50	118-122	20			
MIL-C-43616, Cleaning Compound, Aircraft Surface	48-50	118-122	20			
SAE AS 1241 , Fire Resistant Hydraulic Fluid for Aircraft	48-50	118-122	20			
MIL-L-7808, Lubricating Oil, Aircraft Turbine Engine, Synthetic Base	118-121	244-250	30			
MIL-C-87937, Cleaning Compound, Aircraft Surface, Alkaline, undiluted	63-68	145-154	20			
MIL-C-87937, Cleaning Compound, Aircraft Surface, Alkaline Waterbase, diluted 25175 (fluid/water) ratio	63-68	145-154	20			
TT-S-735, Standard Test Fluids; Hydrocarbon, Type I	20-25	68-77	168			
TT-S-735, Standard Test Fluids; Hydrocarbon, Type II	20-25	68-77	168			
TT-S-735, Standard Test Fluids; Hydrocarbon, Type III	20-25	68-77	168			
TT-S-735, Standard Test Fluids; Hydrocarbon, Type VII	20-25	68-77	168			
MIL-PRF-87252, Coolant Fluid, Hydrolytically Stable, Dielectric	20-25	68-77	168			

# PWRLINE HV™

High-current power feeder system and current return network for metal and composite fuselage aircraft applications



## Unique power feeder system eliminates power line routing and termination issues

For aircraft electrical applications that require discrete routing of 3-phase and DC power lines and ground cables, Glenair has developed the PwrLine HV. PwrLine HV replaces conventional terminal strips and terminal lugs with a solution that eliminates the issues associated with routing large gauge cables. The PwrLine HV uses a crimp contact system that can accommodate tolerancing variations that routinely occur with large cables. Routing power feeders through the 3-D spatial environment routinely creates installation and terminal lug orientation issues. PwrLine eliminates these problems with its unique rotatable pin / socket architecture and unique in-line insulation packaging.

PwrLine HV is a complete power feeder and current return network system that includes contacts, cables, holding fixtures, mountable connector packages, as well as high-voltage terminal blocks and lugs for reduction of partial discharge and corona. Lightweight, high-durability Duraelectric terminal blocks, hoods, and cable jackets deliver outstanding environmental and insulation performance.

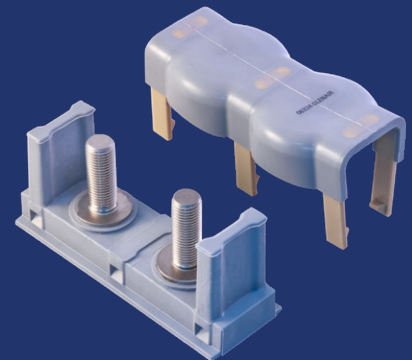

PwrLine HV: a complete power feeder ecosystem with matched, compatible components

# HIGH-CURRENT / HIGH-VOLTAGE PwrLine HV Power Feeder System

GLENAIR  
**QwikConnect**

for aircraft electrical power distribution systems

## PWRLINE HV POWER FEEDER SYSTEM COMPONENTS

- Resolves cable lug misalignment issues
- Eliminates twisted cable (rotational) problems during assembly
- Integrated / compatible power line feeder system used in combination with PowerLoad and other power distribution system connectors

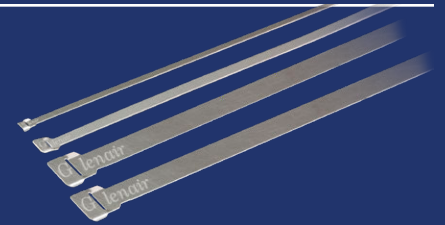

PwrLine HV power feeder system uses Band-Master ATS® termination bands

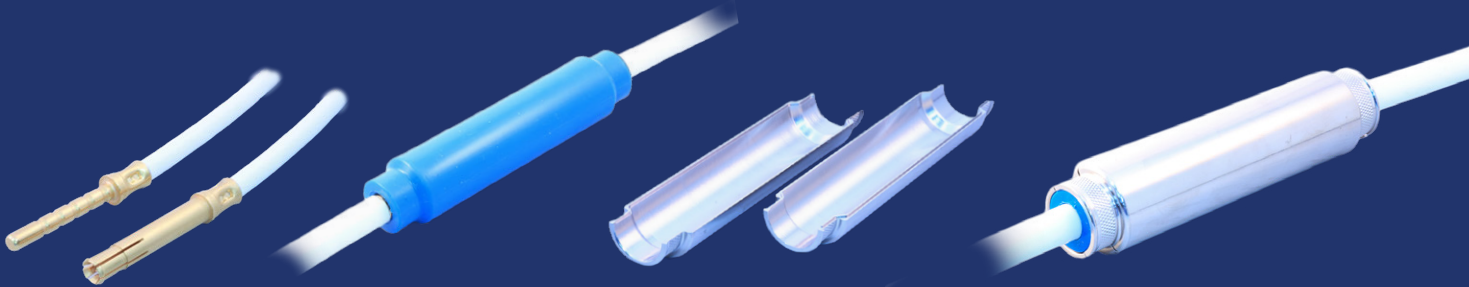

High-current power feeder contact and cable system

Mated contact pair inside self-vulcanizing Duraelectric insulator

Lightweight outer composite split shell with shield banding platforms

Assembled and ready for shield band termination with Band-Master ATS® bands

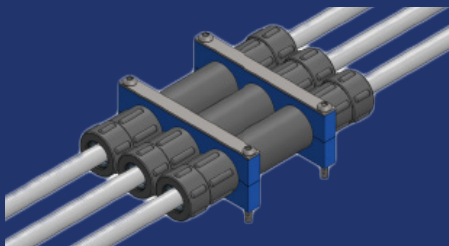

Schematic illustration with line block mounting hardware...

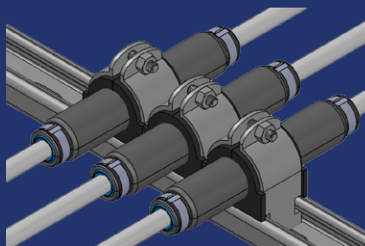

...strut clamp mounting hardware...

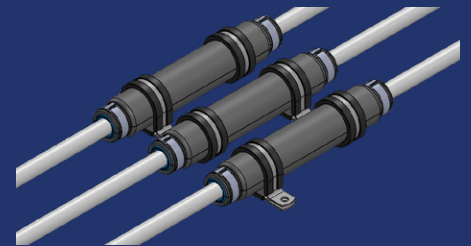

... and P-clamp mounting hardware



Multiple designs of high-voltage terminal blocks with accommodation for PwrLine HV lugs and/or standard lugs

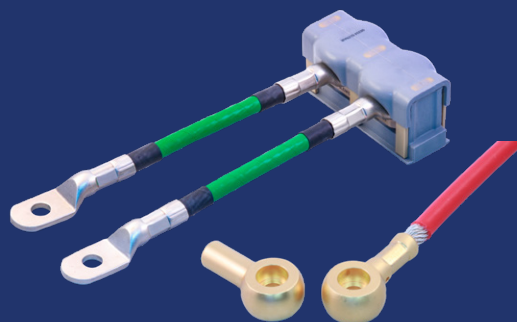

Conventional and PwrLine HV terminal lugs

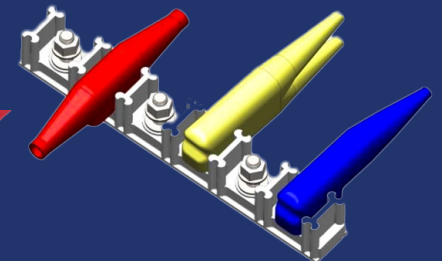

Color-coded terminal lug hoods made from high-performance Duraelectric material

Current Return Network for protection against electromagnetic interference propagated in aircraft power lines

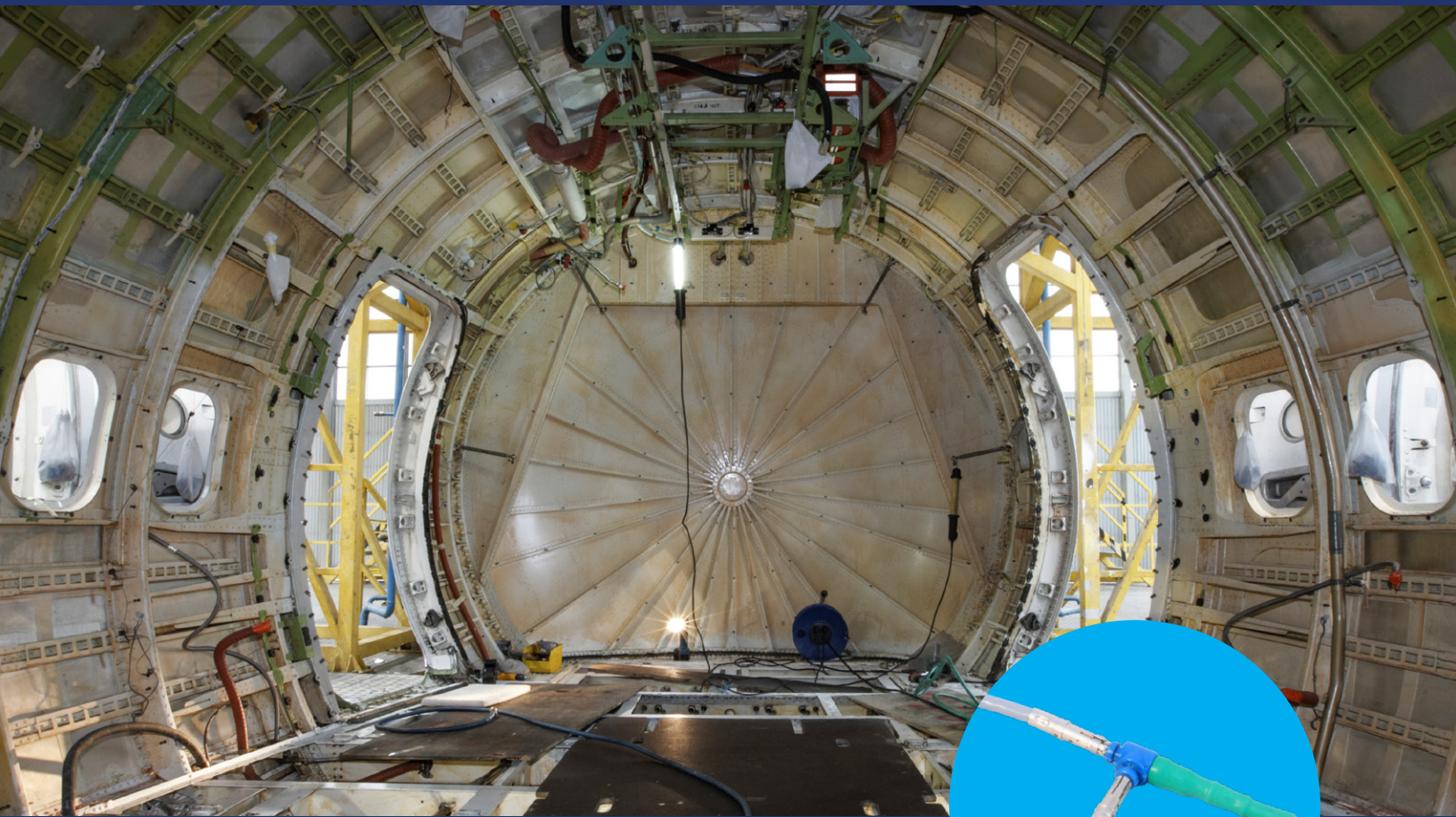

## The PwrLine™ Current Return Network revises traditional approaches to grounding systems on commercial aircraft.

The Glenair Current Return Network grounding solution uses a contact system and Band-Master ATS® grounding technology to simplify routing and termination processes and guarantee a stable electrical interface. Power contacts feature a rotatable pin / socket construction to eliminate twisted cable during assembly. The Duraelectric™ overmolded T fixture and AutoShrink™ boots, easily installed over the fixture's integral boot platforms, provide a durable environmental seal. The design is scalable for lightning strikes and fault currents.

The Current Return Network system employs “plug and play” connections and calibrated banding, eliminating the need for washers and torque wrenches, and waiving inspection requirements. The network's optimized TurboFlex™ wire and 16 mil insulated copper conductor provide both outstanding environmental protection and extreme flexibility.

- Replaces the traditional terminal lug / terminal strip solution
- Resolves cable lug misalignment issues
- Eliminates twisted cable (rotational) problems during assembly
- Integrated / compatible power line feeder system used in combination with PwrLine HV power distribution system

# PwrLine HV™ Ground (Current) Return Network

for aircraft electrical power distribution systems

## CURRENT RETURN NETWORK SYSTEM ILLUSTRATION

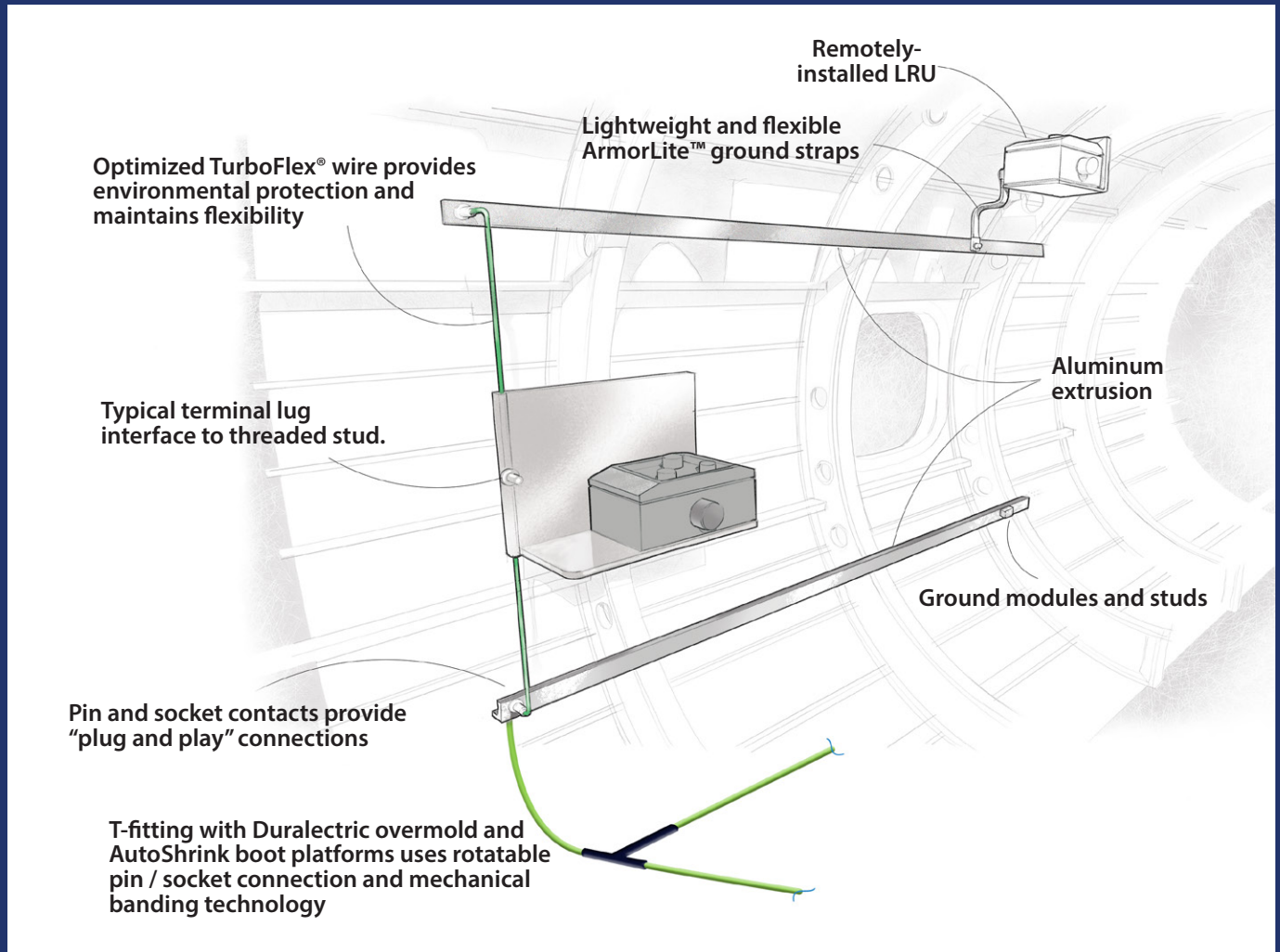

## CURRENT RETURN NETWORK SYSTEM COMPONENTS

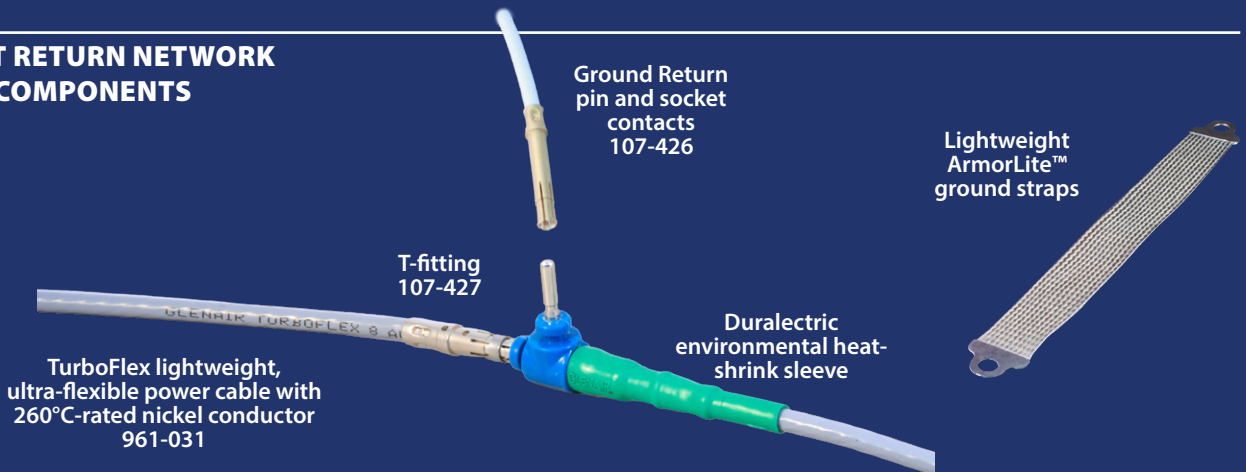

# Band-Master ATS®

EMI/RFI Shield Termination System

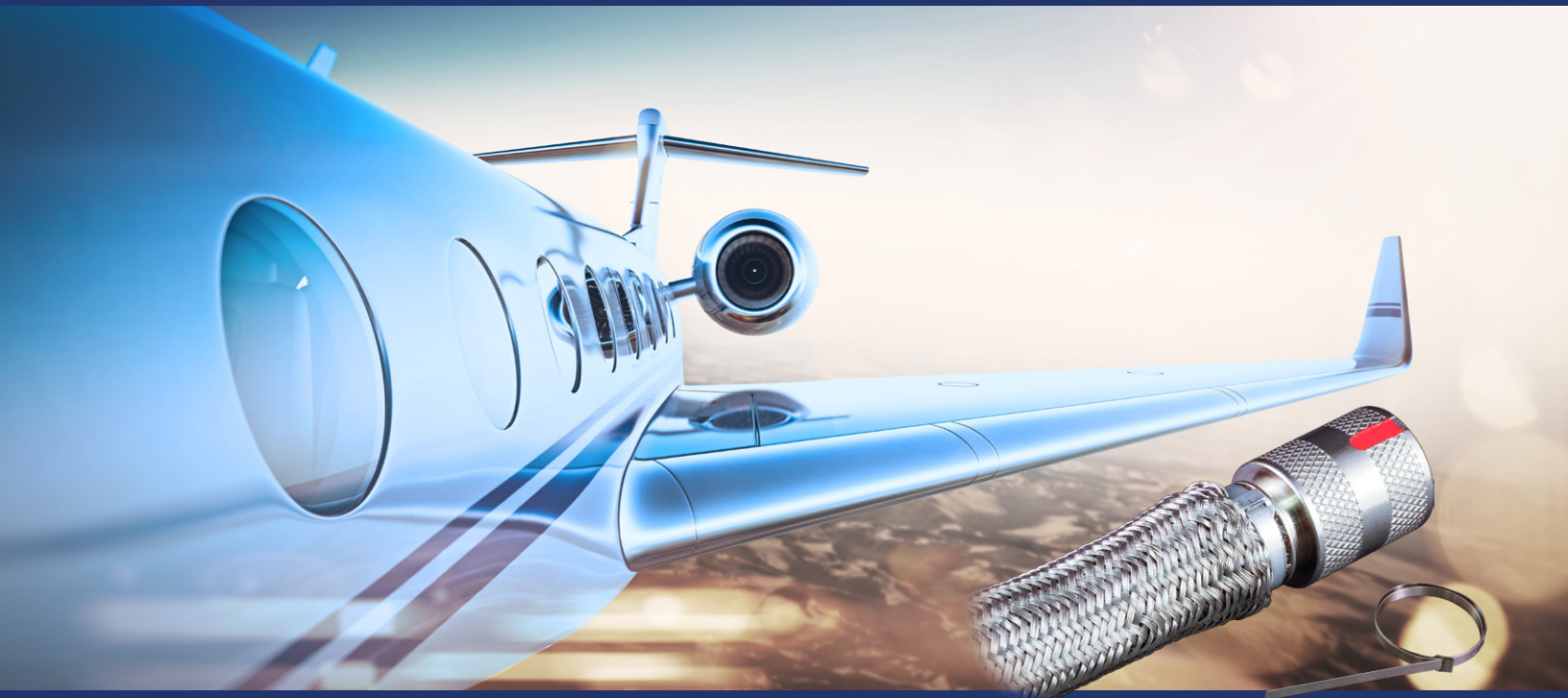

**Quick, easy, cost-effective and highly reliable termination of braided metallic shielding or fabric braid to connectors and backshells**

Band-Master ATS® is the advanced termination system for interconnect cable screen grounding. The unique low profile and smooth inside diameter of the one-piece type 304 austenitic stainless steel clamping band virtually eliminates RFI/EMI/EMP leakage paths. The lock maintains constant tension under extreme environmental conditions. Band-Master ATS® bands have passed severe shock, vibration and thermal cycle testing with negligible deterioration of shell conductivity and have been approved and added to the specifications for the world's largest aircraft manufacturers.

- Precision hand-held tools and termination bands—both from a single supplier
- Innovative Slim Standard and Nano bands reduce weight and improve safety (no buckle cuts)
- Micro-Max tool and bands offer optimal tensile / pull strength

## BAND-MASTER ATS® ADVANCED TERMINATION SYSTEM



Easy-to-use manual tools with built-in calibration counter



High-volume pneumatic tool for bench use







Save time and tool maintenance costs with the Glenair band tool calibration system



# BAND-MASTER ATS® EMI/RFI Shield Termination System

The advanced termination system  
for interconnect cable shielding

Band-Master ATS® Manual Tool Selection	
	<p><b>601-129 Hand Tool for Micro-Max Bands</b></p> <p>The 601-129 Band-Master ATS® Micro-Max Tool weighs 1.1 lbs., and is designed for Micro-Max .120" width clamping bands with a superior tension range from 100-180 lbs, making it the highest pull-strength rated banding solution in the industry. Calibrate at 132 ± 3 lbs. for most shield terminations. Tool and Band should never be lubricated.</p>
	<p><b>601-109 Hand Tool for Slim Standard Bands</b></p> <p>The 601-109 Slim Standard Band-Master ATS® Tool weighs 1.2 lbs., and is designed for slim standard .24" width clamping bands in a tension range from 50 to 100 lbs. Calibrate at 100 lbs. ± 5 lbs. for most shield terminations. Tool and band should never be lubricated.</p>
	<p><b>601-122 Hand Tool for Micro Slim Bands</b></p> <p>The 601-122 Micro Slim Band-Master ATS® Tool weighs 1.2 lbs., and is designed for micro slim .125" width clamping bands in a tension range from 50 to 100 lbs. Calibrate at 82 lbs. ± 3 lbs. for most shield terminations. Tool and band should never be lubricated. <i>Consult factory for band weights and performance specifications.</i></p>
	<p><b>601-101 Hand Tool for Micro Bands</b></p> <p>The 601-101 Micro Band-Master ATS® Tool weighs 1.18 lbs., and is designed for micro .120" width clamping bands in a tension range from 50 to 85 lbs. Calibrate at 80 lbs ± 5 lbs. for most shield terminations. Tool and band should never be lubricated.</p>
	<p><b>601-108 Hand Tool for Nano Bands</b></p> <p>The 601-108 Nano Band-Master ATS® Tool weighs 1.18 lbs., and is designed for nano .075" width clamping bands in a tension range from 20 to 50 lbs. Calibrate at 50 lbs. ± 3 lbs. for most shield terminations. Tool and band should never be lubricated.</p>



Select Slim Standard bands for size and weight savings—50% lighter and lower-profile than standard bands. Terminated "Slim" style bands have a tighter, smoother buckle with no sharp edge to injure assembly technicians. Plus, say goodbye to protective tape wrapping!

Bands	Band-Master ATS® Band Selection					
	Length		Part Number		Fits Diameter	
	in.	mm.	Flat	Pre-Coiled	in.	mm.
Medium Micro-Max Band	8.125	206.38	<b>601-700</b>	<b>601-701</b>	.88	22.4
Long Micro-Max Band	14.25	361.95	<b>601-702</b>	<b>601-703</b>	1.8	45.7
Short Micro Band	5.0	127.0	<b>601-024</b>	<b>601-025</b>	0.5	12.7
Medium Micro Band	8.0	203.2	<b>601-060</b>	<b>601-061</b>	.88	22.4
Long Micro Band	14.0	355.6	<b>601-064</b>	<b>601-065</b>	1.8	47.8
Short Nano Band	6.0	152.4	<b>601-500</b>	<b>601-501</b>	.60	15.2
Medium Nano Band	9.0	228.6	<b>601-504</b>	<b>601-505</b>	.94	23.9
Long Nano Band	14.0	355.6	<b>601-508</b>	<b>601-509</b>	1.8	47.8
Short Slim Standard Band	9.0	228.6	<b>601-570</b>	<b>601-571</b>	1.0	25.4
Medium Slim Standard Band	14.25	362.0	<b>601-572</b>	<b>601-573</b>	1.8	47.8
Short Micro Slim Band	8.125	206.4	<b>601-600</b>	<b>601-601</b>	.88	22.4
Medium Micro Slim Band	14.25	362.0	<b>601-602</b>	<b>601-603</b>	1.8	47.8

# SWING ARM®

3-in-1 lightweight composite clamp with optional drop-in braid termination follower

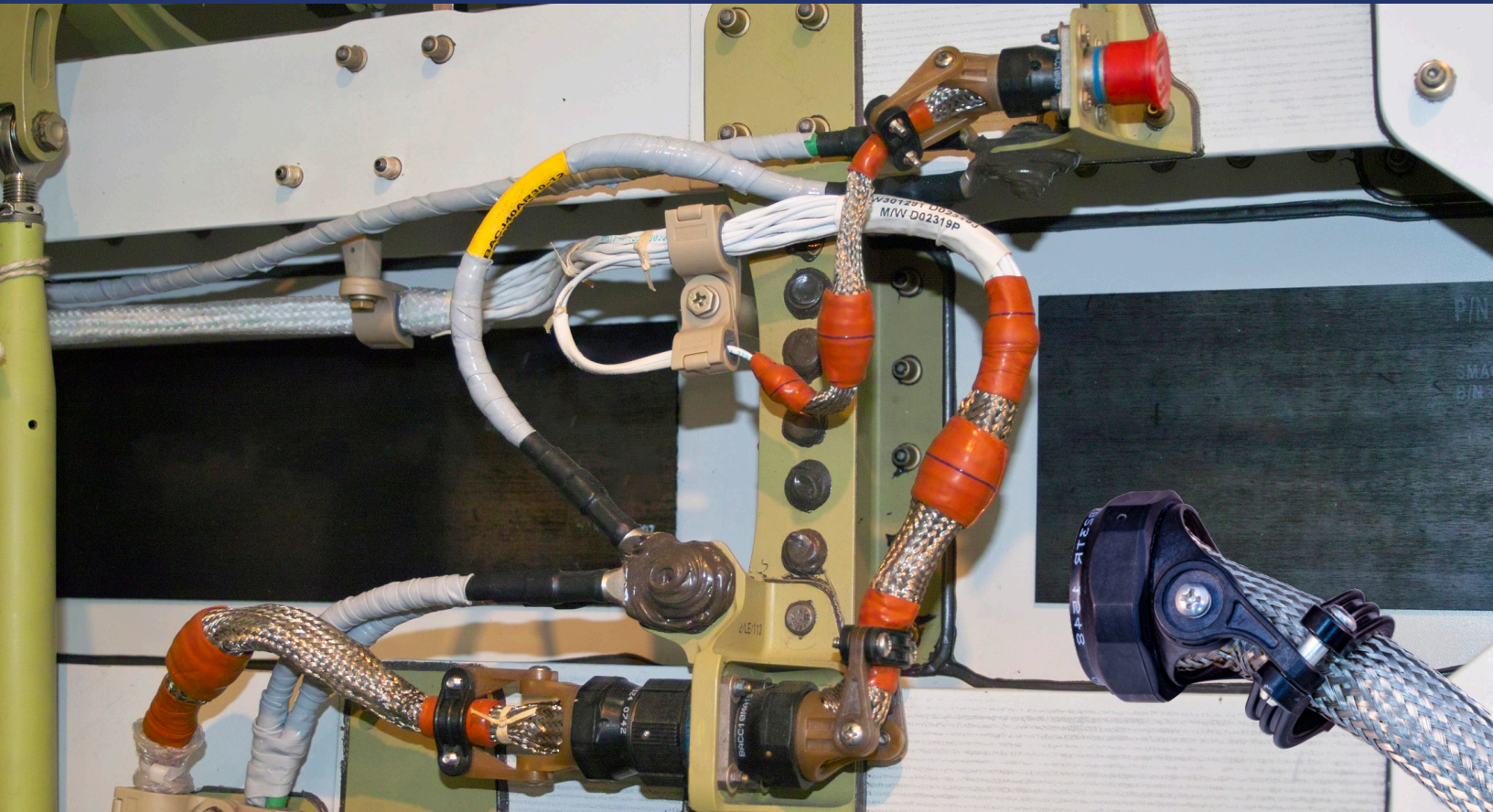

Glenair's composite Swing-Arm® is a lightweight and corrosion-free cable clamp with cable shield termination options for a wide range of EWIS applications. This innovative articulating strain relief has become the standard shield termination device for weight reduction in both military and commercial airframe applications. Made from temperature-tolerant composite thermoplastic, rugged Swing-Arm® clamps offer easy installation, long-term performance, and outstanding weight and SKU reduction. Performance tested to stringent AS85049 mechanical and electrical standards and available for all commonly-specified mil-standard and commercial cylindrical connectors including MIL-DTL-38999, SuperNine, and Series 806 Mil-Aero.

## Introducing Swing-Arm FLEX®, Glenair Next-Generation Composite Swing-Arm® Strain Relief

- Significant weight reduction: no saddle bars or hardware
- Rapid assembly: cable self-centers on bundle, little or no wrapping tape required
- Braid sock and drop-in band termination follower versions for EMI/RFI applications
- Internal conductive ground path

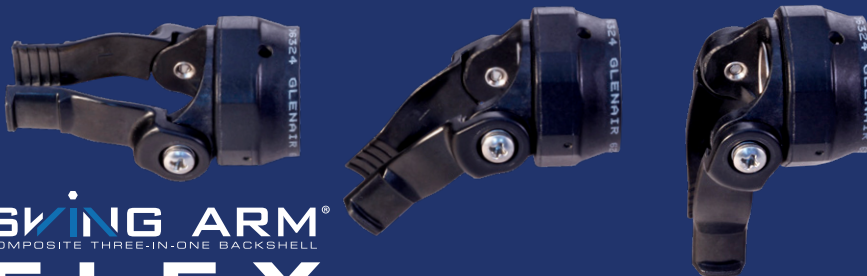

**SWING ARM®**  
COMPOSITE THREE-IN-ONE BACKSHELL  
**FLEX**

User-configurable straight, 45°, and 90° cable routing

# SWING-ARM 3-IN-1 LIGHTWEIGHT Composite thermoplastic strain-relief and EMI/RFI shield termination device

GLENAIR  
**QwikConnect**

## THREE STYLES OF SWING-ARM STRAIN RELIEF CLAMPS

- Style A - standard mouth, rigid saddle bars
- Style B - wide mouth (for larger cable diameters), rigid saddle bars
- Style C Swing-Arm FLEX - no saddle bars, self-centering round cable strain relief

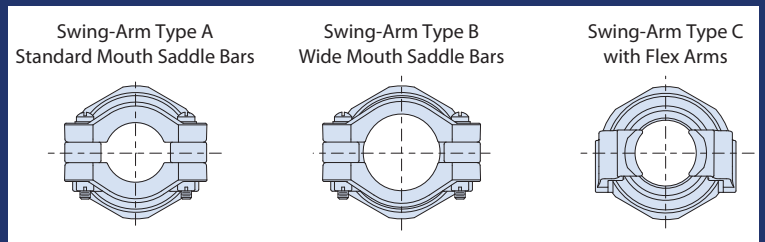

## SWING-ARM VERSATILITY: FROM SIMPLE CABLE STRAIN RELIEF TO EMI/RFI SHIELD TERMINATION



Fast and reliable termination of individual wire and overall EMI cable shielding with industry-standard Band-Master ATS® tools and straps. New slim profile bands eliminate sharp strap cutoff for improved safety.

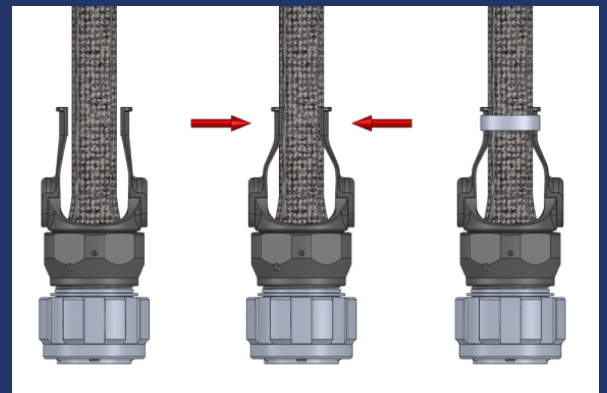

## DROP-IN FOLLOWER FOR DIRECT TERMINATION OF OVERALL OR INDIVIDUAL WIRE SHIELDING

Two drop-in-follower designs, solid and slotted are available for all Swing-Arm styles (A, B, and C).



## SWING-ARM AND SWING-ARM FLEX WITH OPTIONAL INTEGRATED SHIELD SOCK

For fast and reliable EMI/RFI shield termination of individual wire and overall cable shielding



## SWING-ARM SHIELD SOCK TERMINATION OPTIONS, STANDARD SPLIT RING OR STARSHIELD STAR

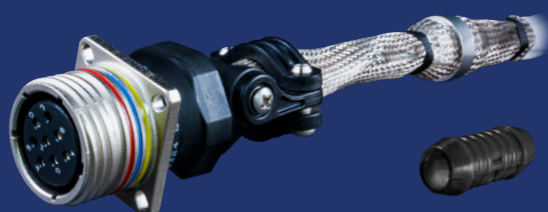

Termination of shield sock to cable shield with split support ring

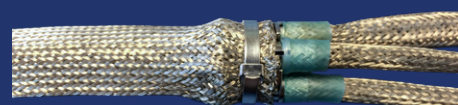

Termination of shield sock to individual wire shields with auxiliary "flex shield" HST and StarShield™ Star



# Outlook

## Can We Have a Chatbot?

At the risk of dating myself as old timer, I can remember when customer-service phone calls to a business were picked up by a real human being instead of an automated system with touch-tone menu choices. Looking back, I think the automated switchboard was the end of an era for good customer service—the era when personalized interactions with a live representative demonstrated a company's commitment to quality service.

Now it is the "Chatbot's" turn to make its mark on customer service. And from what I hear, the same big advantage is once again being touted. Save money! 30%, 40%, even 50% savings compared to a live operator or technical support professional. And since so many customer requests for support and service are essentially for the same "frequently asked question," why not just automate the whole process and eliminate some costly members of the team?

Well, for those of you interested in how we do things at Glenair, here are some reasons we will not be transitioning to any form of automated AI or "Chatbot" in our customer service and support departments.

1. *Lack of Human Touch:* For our money, Chatbots lack the empathy and understanding that only a human customer service representative can provide. We know for a fact our customers treasure the personalized interactions they enjoy with our team and would feel frustrated were we to implement a software program interface to Glenair customer service.
2. *Limited Ability to Understand Accents and Non-Native English:* Our sense is that artificial intelligence still has real limitations in its ability to understand and respond to complex customer queries—especially if the speaker is using heavily-accented or colloquial speech. Talk about a recipe for frustration! What happens if a slight mispronunciation results in an incorrect part number getting ordered, or the wrong Glenair Assembly Procedure being used?
3. *Negative Customer Perception:* If (or when) a Chatbot interaction fails to meet customer expectations, what is the likely outcome? Naturally, it will lead to a negative perception of Glenair's customer service as a whole. The last thing we would ever want is for our customers to believe we are unresponsive, impersonal, or lacking in human support. Saves you money? Yep, at the cost of potentially damaging our brand and impacting customer loyalty.

When automated switchboards became the rage, we stuck to our guns and kept our live operators and customer service pros on the phones. And we have heard time and time again from our customers how much they appreciate the human touch they get from Glenair. As for Chatbots, no thanks. That's a conversation we don't care to have.

*Chris Toomey*

# QwikConnect

GLENAIR • Volume 27 • Number 3

## Publisher

Christopher J. Toomey

## Managing Editor

Marcus Kaufman

## Art Director/Editor

Mike Borgsdorf

## Graphic Designer

George Ramirez

## Deputy Editor

Meghan Taylor

## Technical Consultant

Jim Donaldson

## Issue Contributors

Robert Johnson

Guido Hunziker

William Ritner

Jose Silva

## Distribution

Terry White

To subscribe or unsubscribe,  
please contact Terry White:  
twhite@glenair.com

QwikConnect is published quarterly by Glenair, Inc. and printed in the U.S.A. All rights reserved. © Copyright 2023 Glenair, Inc. A complete archive of past issues of QwikConnect is available on the Internet at [www.glenair.com/qwikconnect](http://www.glenair.com/qwikconnect)

## GLENAIR, INC.

1211 AIR WAY  
GLENDALE, CA 91201-2497  
TEL: 818-247-6000  
FAX: 818-500-9912  
E-MAIL: [sales@glenair.com](mailto:sales@glenair.com)  
[www.glenair.com](http://www.glenair.com)

