

Datamate **Coax**



HARWIN

Datamate **Coax**

Traditional solution

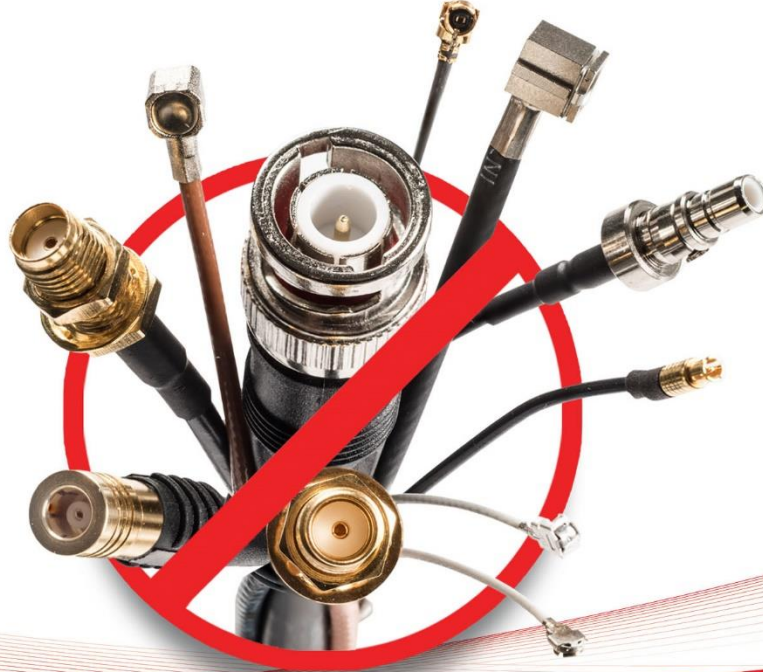
**HARWIN**

Traditional RF contacts are typically packaged as single bayonet or screw type connections. These can be suitable for single connection requirements, but prone to misconnection or mis-mating when multiple connections are required. The more connections required, these issues and risks are multiplied. Assembly time also increases with individual screw-type connectors slowing down assembly speeds.

Datamate **Coax**

4mm pitch **ganged connectors**



HARWIN

Datamate Coax solutions are a 4.00mm pitch, Ganged connector system. Multiple coax connections are faster and more secure than both the traditional solutions and competitor's ganged connector products. These connectors are a high-reliability compact design, capable of increasing production assembly speeds with just one connection.

Datamate **Coax**

The **heart** of the connector



HARWIN

Datamate Coax uses high-quality, high-reliability 50Ω gold-plated coaxial contacts. These contacts are precision-turned Beryllium Copper parts manufactured at our UK headquarters, ideal for vibration environments and multiple insertions. The insulator material is PTFE, to withstand high temperatures.

Datamate **Coax**

Plug connectors - Male PC Tail, **Vertical** Layout

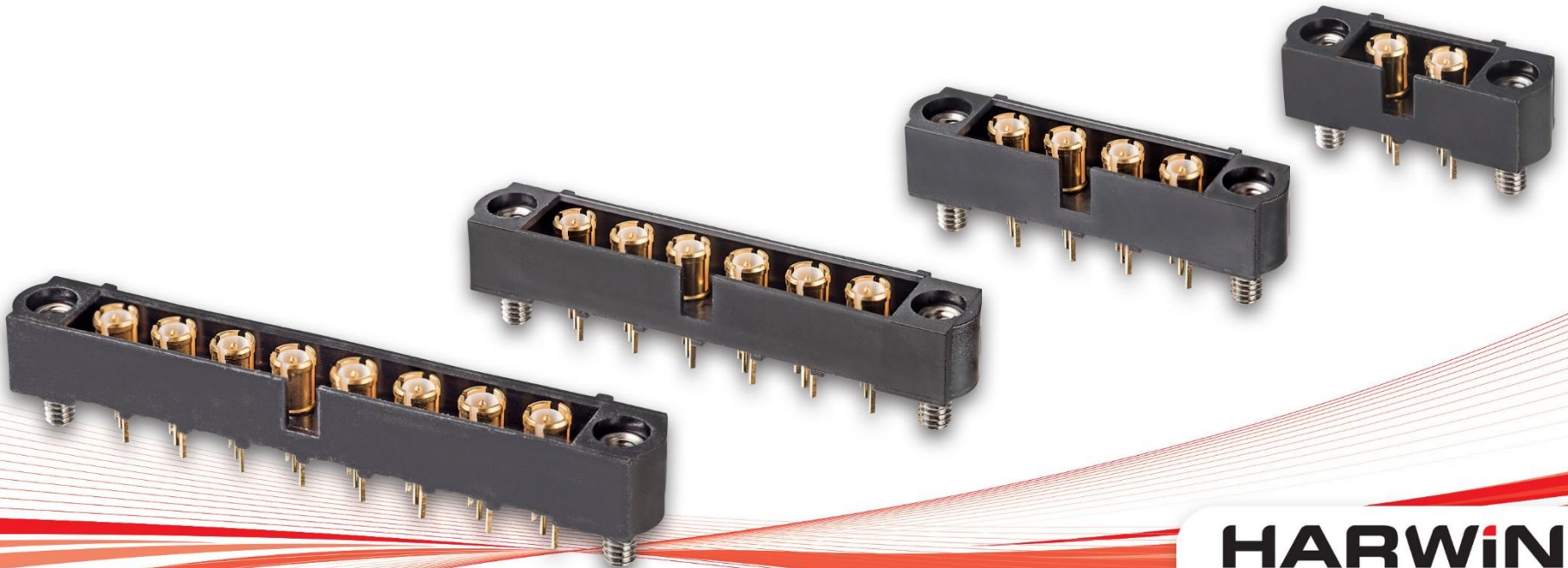
**HARWIN**

For the Vertical connectors in the Datamate Coax range, 4 contact counts in two PC Tail sizes are stocked for short lead-times:

3mm PC Tail connectors:

- [M80-MV311M2-02](#)
- [M80-MV311M2-04](#)
- [M80-MV311M2-06](#)
- [M80-MV311M2-08](#)

4.5mm PC Tail connectors:

- [M80-MV312M3-02](#)
- [M80-MV312M3-04](#)
- [M80-MV312M3-06](#)
- [M80-MV312M3-08](#)

Datamate **Coax**

Plug connectors - Male PC Tail, **Horizontal** Layout

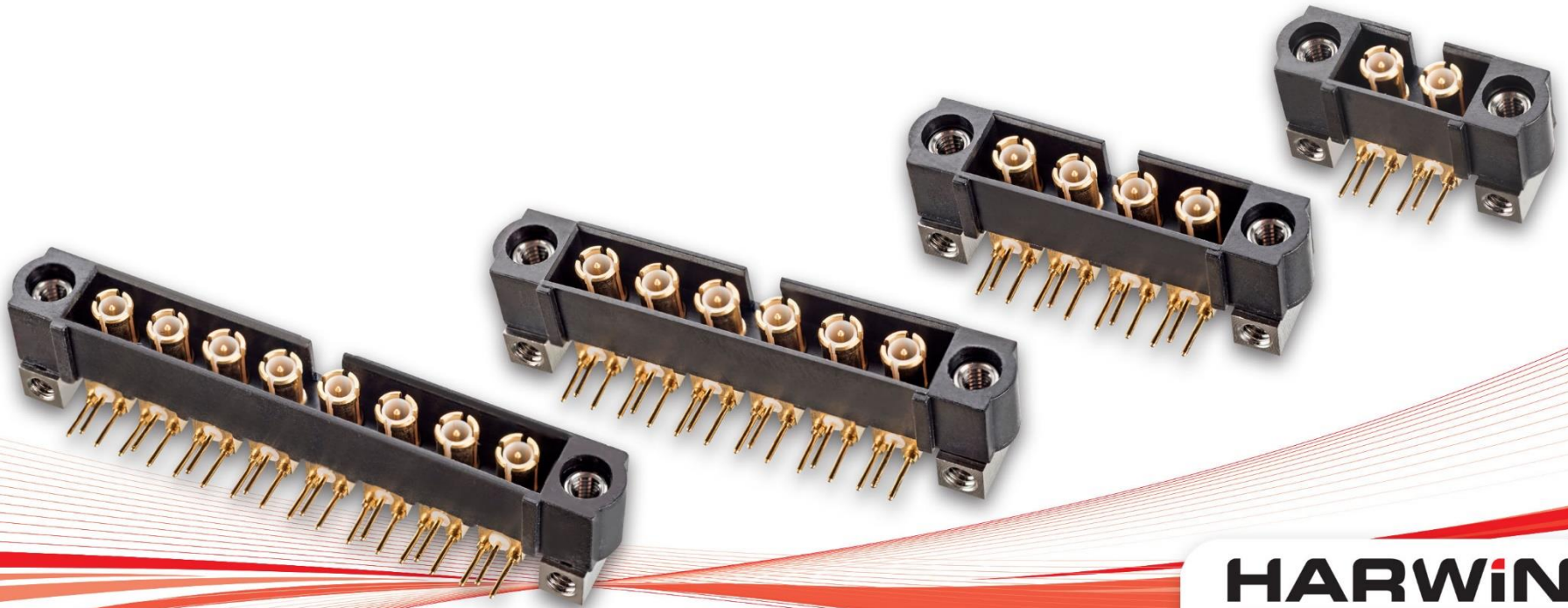
**HARWIN**

Horizontal connectors are also available in 4 contact counts in two PC Tail sizes – giving flexibility in stocked product:

3mm PC Tail connectors:

- [M80-MH313M5-02](#)
- [M80-MH313M5-04](#)
- [M80-MH313M5-06](#)
- [M80-MH313M5-08](#)

4.5mm PC Tail connectors:

- [M80-MH314M5-02](#)
- [M80-MH314M5-04](#)
- [M80-MH314M5-06](#)
- [M80-MH314M5-08](#)

Datamate **Coax**

Plug **Accessories** – For vertical and horizontal layouts



For Horizontal



For Vertical

Board fixings for the Male Vertical and Horizontal connectors are sold separately to the connectors:

For Horizontal connectors:

- 3.5mm Slotted Bolt: [M80-2260000B](#)
- 5mm Slotted Bolt: [M80-2270000B](#)
- 5mm Hex Socket Bolt: [M80-2320000B](#)

For Vertical connectors:

- Slotted Nut: [M80-2130000B](#)
- Hexagonal Nut: [M80-2430000B](#)

HARWIN

Datamate **Coax**

Jack connectors – Female Cable for **tailored cable assemblies**

**HARWIN**

Cable connectors are suitable for RG178 or similar $\varnothing 2\text{mm}$ coax cable, and are stocked in kits of contacts and housings. Available in 4 contact counts to match the previous Male connectors.

- [M80-FC305F1-02](#)
- [M80-FC305F1-04](#)
- [M80-FC305F1-06](#)
- [M80-FC305F1-08](#)

Datamate **Coax**

Ready-made Female Cable assemblies, Off-The-Shelf

**HARWIN**

Fully complete Cable Assemblies can be purchase direct from stock, in a choice of single or double end, using RG178 cable:

Single Ended Assemblies:

- [M80-FC305F1-02-0150L](#)
- [M80-FC305F1-04-0150L](#)
- [M80-FC305F1-06-0150L](#)
- [M80-FC305F1-08-0150L](#)

Double Ended Assemblies:

- [M80-FC305F1-02-0150F1](#)
- [M80-FC305F1-04-0150F1](#)
- [M80-FC305F1-06-0150F1](#)
- [M80-FC305F1-08-0150F1](#)

Datamate **Coax**

Protected contacts – **Shrouded and Polarised**

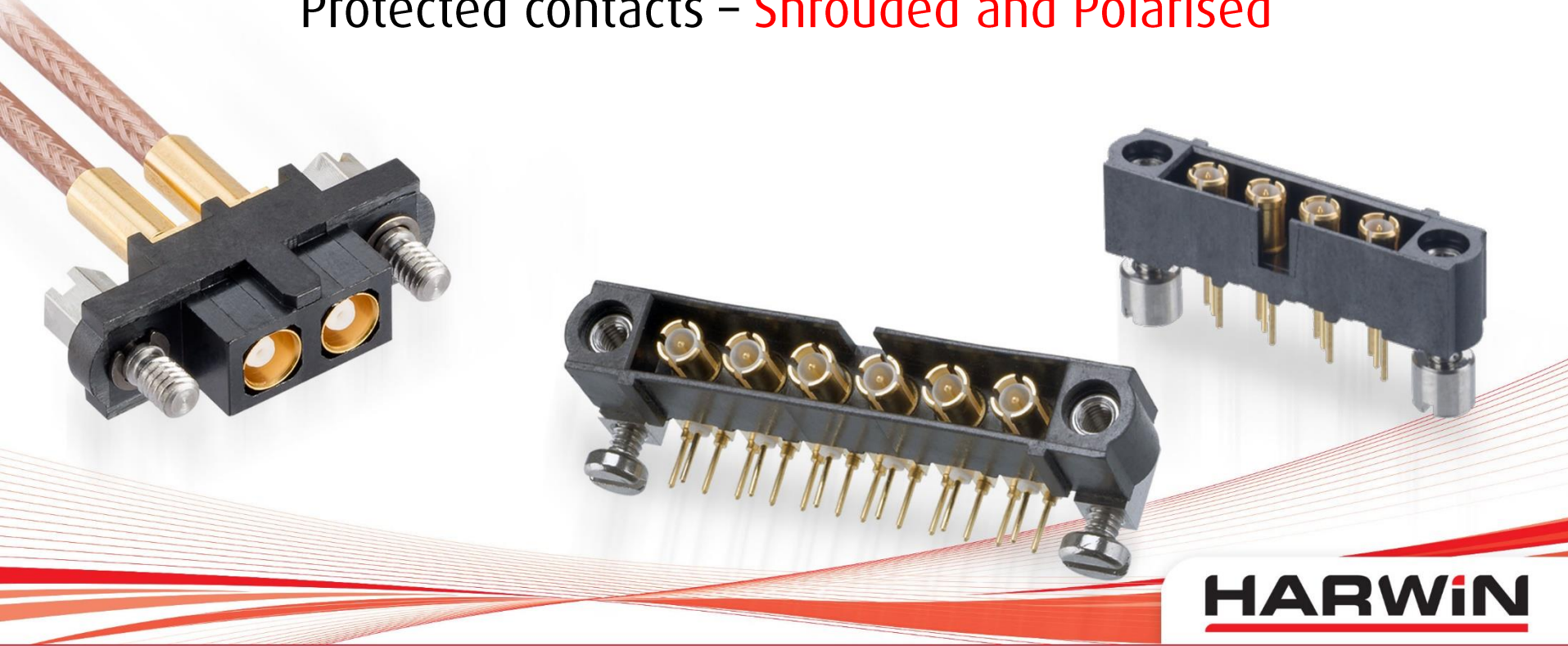
**HARWIN**

The shrouded housing design protects both male and female contacts prior to, and during, mating cycles. The central polarisation feature eliminates mis-mating due to incorrect orientation. Both features give superior functionality over other ganged coax systems currently available.

Datamate **Coax**

Robust fixings for security and strain relief

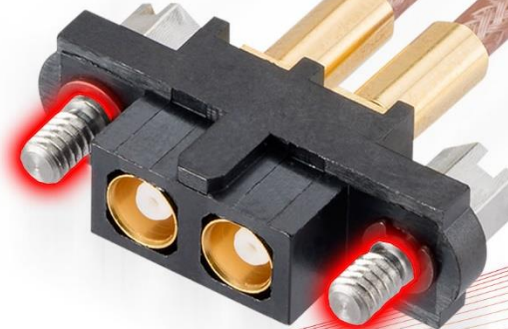
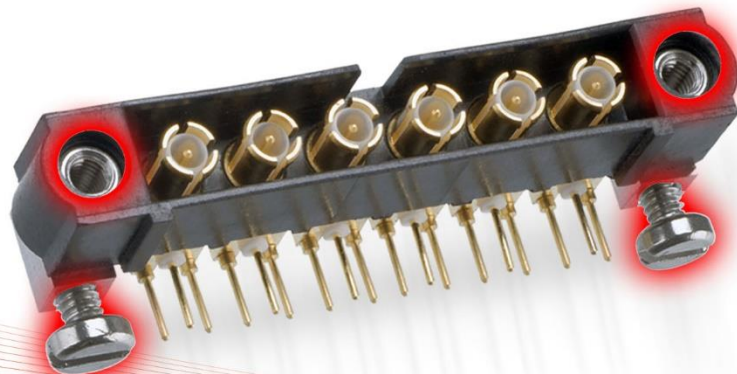

HARWIN

Stainless Steel jackscrew fixings are added for strong and secure mating, both to mating connectors and board-mounting to the PCB. Developed for high-reliability in applications subject to vibration and shock, these jackscrew systems provide excellent robust strain relief.

Datamate **Coax**

Hand Tools for manufacturing cable assemblies

**HARWIN**

Harwin also supply the full set of hand tooling required for your own cable assembly manufacture (Instruction Sheets are available on the website):

Crimp Tool: Outer Sleeve:

- [Z80-293](#)

Crimp Tool – Inner Contact:

- [Z80-292](#)

Positioner – Inner Contact:

- [Z80-291](#)

Contact Removal Tool:

- [Z80-290](#)

Datamate **Coax**

Electrical Specifications

Frequency Range	Up to 6 GHz
Impedance	50 ohms
Voltage Standing Wave Ratio (VSWR)	1.05 + (0.04 x Frequency) GHz max
Operating Voltage	180V _{ac} at 500mA

HARWIN

The Datamate Coax design is capable of a frequency range up to 6 GHz, with an impedance of 50 ohms. Maximum voltage is set at 1,000V_{ac}, and Insulation Resistance within each coax is 10⁶ megaohms. [Test report HT020](#) and [Test report HT052](#) are available from the website.

Datamate **Coax**

Mechanical & Environmental Specifications

Vibration	10g - 6 hours
Shock	100g - 0.006 seconds
Durability	500 mating cycles
Temperature Range	-55°C to +125°C

**HARWIN**

The Datamate Coax performs to the same high reliability standard consistent throughout the Datamate range. These specifications make these products the ideal choice for demanding applications.

Datamate **Coax**

Outgassing



HARWIN

The PPS plastic used in the construction of Datamate Coax housings has a Space heritage. Details can be found in the [Harwin Outgassing support article](#).

Datamate **Coax**

Markets



HARWIN

Many markets have a requirement for rugged, high-reliability coax connectors. Datamate has a proven track record in these industries, and Datamate Coax is designed and built to the same exacting standard.

- Aerospace
- Medical
- Field Comms
- Robotics
- Marine

If you like this product, try...

gecko - 1.25mm Pitch

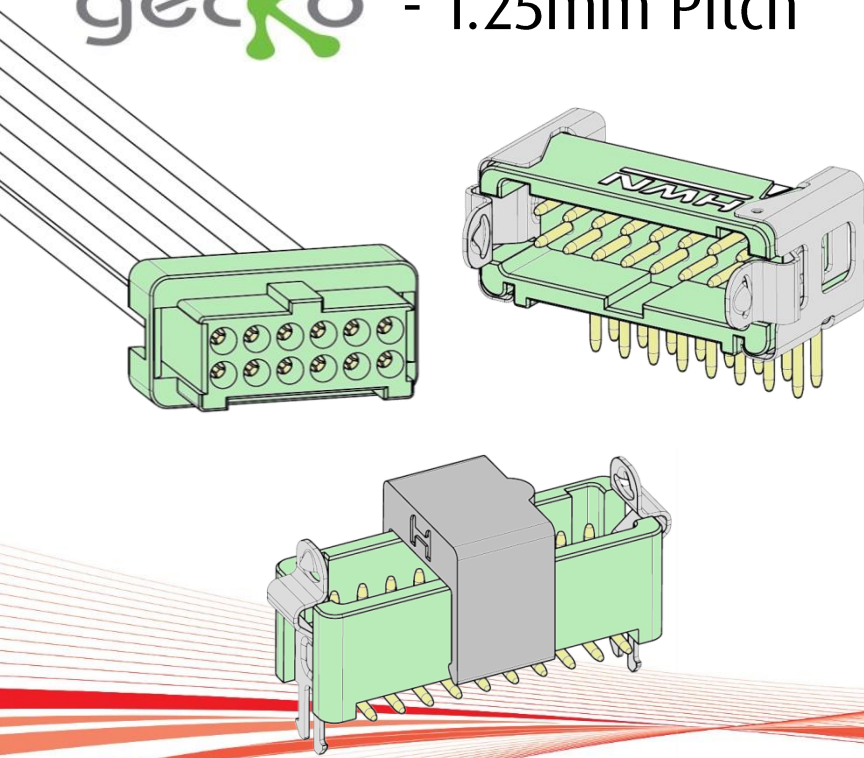

Datamate - 2.00mm Pitch

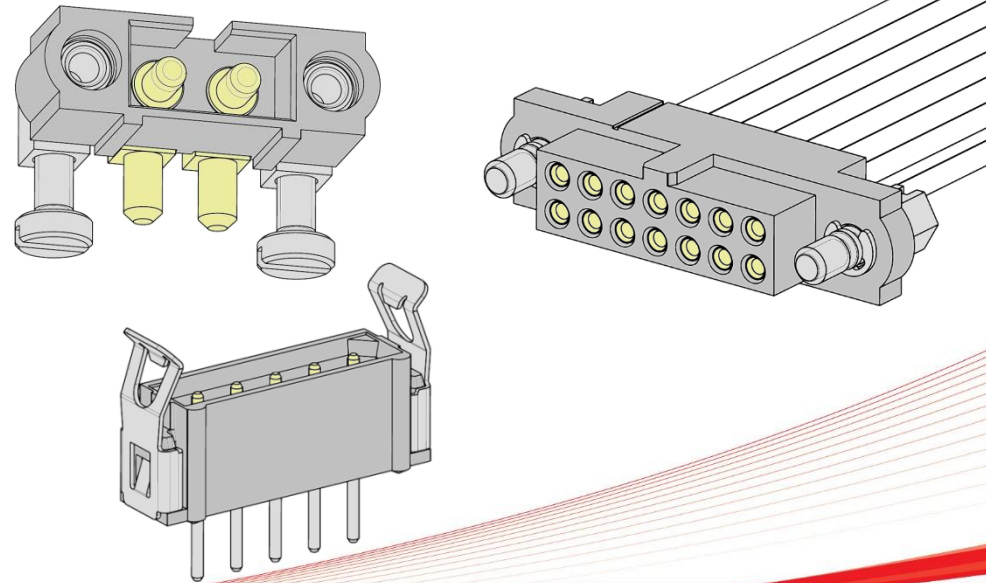

HARWIN

- 2A per contact
- Locking latch system for strain relief
- Resists Vibration to 20G and Shock to 50G
- Temperature range -65 deg C to +150 deg C
- Vertical, Horizontal and Cable options

- 3A per signal, up to 40A per power contact
- Jackscrew or latching system for strain relief
- Resists Vibration to 10G and Shock to 100G
- Temperature range -55 deg C to +125 deg C
- PCB connectors in Throughboard or SMT, Cable options

Get Help from a Harwin Expert

Our experts are specialists in their field with many years of experience in their respective roles and industries.

Find an expert that can help you with your enquiry.

Click Here >>

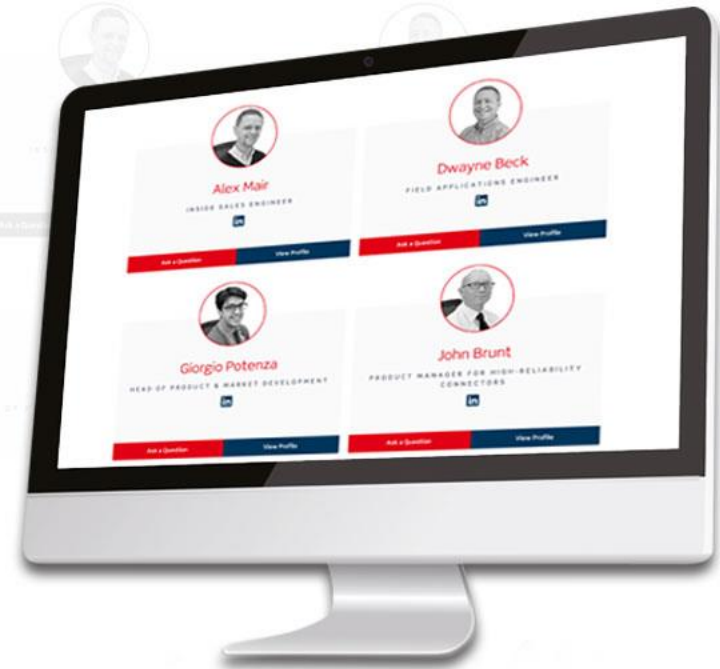

CAD Models and Evaluation Samples also available at www.harwin.com

HARWIN